

---

# LOGICA

---

**Catalistino  
2024**







LINEAR SYSTEM

	Linear 6		Streamlight System 7		Streamlight Incasso 9
	Streamlight accessori 8				

MAGNETIC SYSTEM

	Klik Klak 10		Binario Klik Klak e accessori 18		Klik Klak Mini 20
	Binario Klik Klak Mini e accessori 26		Klik Klak Micro 28		Binario Klik Klak Micro e accessori 32



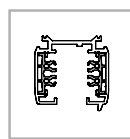

















TRACK

	Fulgor 34		Sun_111 40		Unico Dicro 41
	Unico AR111 41		Sospensioni Track 42		Streamlight Track 44
	Emergenza 49		Tracks Tracks incasso + accessori 45-46		

DOWNLIGHTS

	Deep_EVO EXTR. 50-52-54		Deep_EVO LESS EXTR. 51-53-55		Deep_EVO 56
	Deep_EVO LESS 57		Deep_EVO GU10 58		Deep_EVO LESS GU10 59

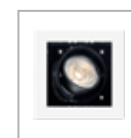
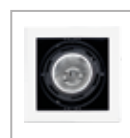
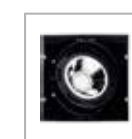









DOWNLIGHTS

	Deep_EVO GRANDE 60		Deep_EVO LESS GRANDE 61		Deep_EVO_Q 62
	Deep_EVO LESS_Q 62		Deep_EVO_Q GU10 63		Deep_EVO_Q GRANDE 63
	Deep_EVO STD 64		MODULI LED e Accessori 66		Light_35 68
	Light_50 69		Light_111 70		Fulgor_IN 71
	Bellatrix 72		Punto Punto L 73-74		Occhio 75
	Mini 76		Zeus 79		Aqua_EVO COB 80
	Aqua_EVO SMD 80		Frame 82		Frame 111 83
	Frameless 85		Frameless 111 86		Wizard 88









SUSPENSION LIGHTS

	A+B 89		Shanghai 90		Cyl Sosp 92
---	-----------	---	----------------	---	----------------

**CEILING LIGHTS**

	A+B 92		Fulgor 93		Sun_111 94
	Unico Dicro 95		Klik Klak puntiforme 96		Cyl 97
	Altair 98		Box Dicro 100		Box 111 100
	Container 101		Container 111 102		

**WALL LIGHTS**

	Minima 104		Essential 105		Su&Giù 106
	Bloc_Evo 106		Dumbo 107		Sun_111 94
	Fulgor 93		Unico Dicro 95		Altair 98

**PROFILES**

	Wall 108		Onda 109		Line_EVO 110
	Line DEEP 112		Line 113		Double 114





**PROFILES**

	PR1 115		PR1_DEEP 115		PR2 116
	PR2_DEEP 116		PR3_EVO 117		

**RECHARGEABLE**

	Twiggy_LESS 118		Diogene 120		Iota 122
	Zen 123		Caricatore multiplo 118-123		Espositore Wireless 124

**OUTDOOR**

	Slice 125		Titano EVO 126		Moonlight 130
	Fos 132		Combi_Evo 133		Dardo 134
	Skorpio 135				

**DRIVER E ACCESSORI**

	Driver e Accessori 137
---	---------------------------

# LINEAR DALI\_PUSH



LED SAMSUNG  
CRI >90  
PF 0,95

CODE	FINISHING	WATT	LUMEN	WATT LIGHT SOURCE	LUMEN LIGHT SOURCE	BEAM	KELVIN	KG	PRICE
41893	Bianco/white	32W	2270	28W	3320	70°	3000K	3,50	229,00
41894	Bianco/white	32W	2280	28W	3370	70°	4000K	3,50	229,00
41895	Nero/Black	32W	2270	28W	3320	70°	3000K	3,50	229,00
41896	Nero/Black	32W	2280	28W	3370	70°	4000K	3,50	229,00
41897	Bianco/white	47W	3320	42W	5000	70°	3000K	4,90	285,00
41898	Bianco/white	47W	3390	42W	5500	70°	4000K	4,90	285,00
41899	Nero/Black	47W	3320	42W	5000	70°	3000K	4,90	285,00
41900	Nero/Black	47W	3390	42W	5500	70°	4000K	4,90	285,00
41901	Bianco/white	64W	4470	57W	6772	70°	3000K	6,20	345,00
41902	Bianco/white	64W	4530	57W	6800	70°	4000K	6,20	345,00
41903	Nero/Black	64W	4470	57W	6772	70°	3000K	6,20	345,00
41904	Nero/Black	64W	4530	57W	6800	70°	4000K	6,20	345,00

## INSTALLAZIONE APPLICATION

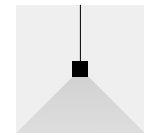

Sospensione/  
Suspension

## DISEGNI TECNICI TECHNICAL DRAWINGS

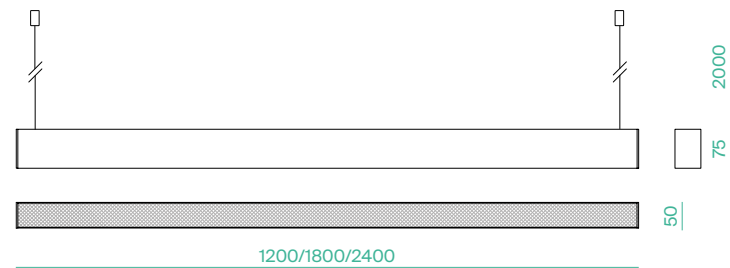

# STREAMLIGHT SYSTEM

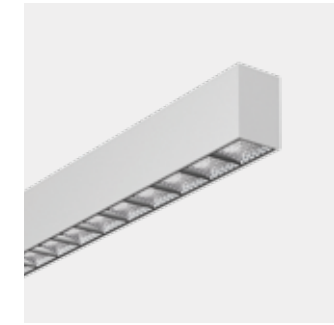

LED SAMSUNG  
CRI >82  
PF 0,9

CODE	FINISHING	WATT	LUMEN	WATT LIGHT SOURCE	LUMEN LIGHT SOURCE	BEAM	KELVIN	DRIVER	KG	PRICE
42654	Bianco/ White	27W+3W	2700 +300	22.5W+2.5W	3375+375	85°*85°	3000K	ON-OFF 36V-750mA	1,80	233,59
42655	Nero/Black	27W+3W	2700 +300	22.5W+2.5W	3375+375	85°*85°	3000K	ON-OFF 36V-750mA	1,80	233,59
42656	Bianco/ White	27W+3W	2800 +400	22.5W+2.5W	3600+400	85°*85°	4000K	ON-OFF 36V-750mA	1,80	233,59
42657	Nero/Black	27W+3W	2800 +400	22.5W+2.5W	3600+400	85°*85°	4000K	ON-OFF 36V-750mA	1,80	233,59
42662	Bianco/ White	41W+4W	4300 +400	34.2W+3.8W	5310+590	85°*85°	3000K	ON-OFF 36V-1250mA	3,50	378,95
42663	Nero/Black	41W+4W	4300 +400	34.2W+3.8W	5310+590	85°*85°	3000K	ON-OFF 36V-1250mA	3,50	378,95
42664	Bianco/ White	41W+4W	4500 +500	34.2W+3.8W	5625+625	85°*85°	4000K	ON-OFF 36V-1250mA	3,50	378,95
42665	Nero/Black	41W+4W	4500 +500	34.2W+3.8W	5625+625	85°*85°	4000K	ON-OFF 36V-1250mA	3,50	378,95
42776	Bianco/ White	27W+3W	2700 +300	22.5W+2.5W	3375+375	85°*85°	3000K	1-10V 36V-750mA	1,80	283,14
42777	Nero/Black	27W+3W	2700 +300	22.5W+2.5W	3375+375	85°*85°	3000K	1-10V 36V-750mA	1,80	283,14
42778	Bianco/ White	27W+3W	2800 +400	22.5W+2.5W	3600+400	85°*85°	4000K	1-10V 36V-750mA	1,80	283,14
42779	Nero/Black	27W+3W	2800 +400	22.5W+2.5W	3600+400	85°*85°	4000K	1-10V 36V-750mA	1,80	283,14
42780	Bianco/ White	41W+4W	4300 +400	34.2W+3.8W	5310+590	85°*85°	3000K	1-10V 36V-1250mA	3,50	424,73
42781	Nero/Black	41W+4W	4300 +400	34.2W+3.8W	5310+590	85°*85°	3000K	1-10V 36V-1250mA	3,50	424,73
42782	Bianco/ White	41W+4W	4500 +500	34.2W+3.8W	5625+625	85°*85°	4000K	1-10V 36V-1250mA	3,50	424,73
42783	Nero/Black	41W+4W	4500 +500	34.2W+3.8W	5625+625	85°*85°	4000K	1-10V 36V-1250mA	3,50	424,73
42658	Bianco/ White	27W+3W	2700 +300	22.5W+2.5W	3375+375	85°*85°	3000K	DALI 36V-750mA	1,80	322,08
42659	Nero/Black	27W+3W	2700 +300	22.5W+2.5W	3375+375	85°*85°	3000K	DALI 36V-750mA	1,80	322,08
42660	Bianco/ White	27W+3W	2800 +400	22.5W+2.5W	3600+400	85°*85°	4000K	DALI 36V-750mA	1,80	322,08
42661	Nero/Black	27W+3W	2800 +400	22.5W+2.5W	3600+400	85°*85°	4000K	DALI 36V-750mA	1,80	322,08
42666	Bianco/ White	41W+4W	4300 +400	34.2W+3.8W	5310+590	85°*85°	3000K	DALI 36V-1250mA	3,50	473,33
42667	Nero/Black	41W+4W	4300 +400	34.2W+3.8W	5310+590	85°*85°	3000K	DALI 36V-1250mA	3,50	473,33
42668	Bianco/ White	41W+4W	4500 +500	34.2W+3.8W	5625+625	85°*85°	4000K	DALI 36V-1250mA	3,50	473,33
42669	Nero/Black	41W+4W	4500 +500	34.2W+3.8W	5625+625	85°*85°	4000K	DALI 36V-1250mA	3,50	473,33

## INSTALLAZIONE APPLICATION

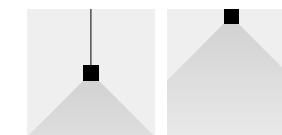

Sospensione/  
Suspension      Soffitto/Ceiling

## DISEGNI TECNICI TECHNICAL DRAWINGS

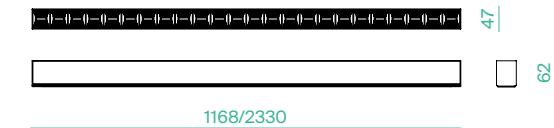





42672

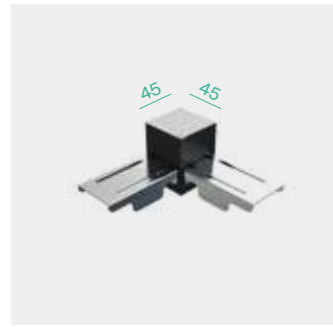

42673 - 42674

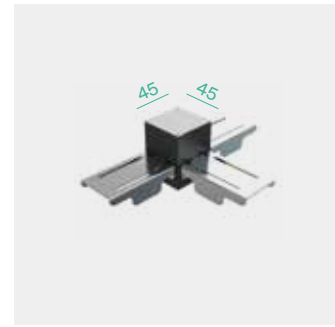

42677 - 42678

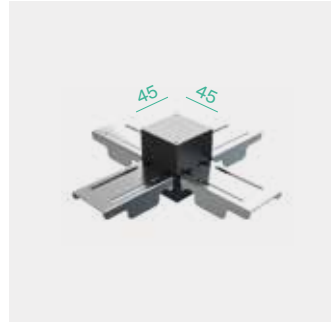

42675 - 42676

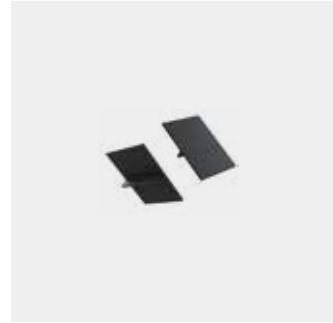

42679 - 42680



42681 - 42682 - 42685



42728

CODE	DESCRIPTION	FINISHING	PRICE
42672	Congiunzione Lineare/Linear Connector	Alluminio/Aluminium	7,08
42673	Giunto "L"/"L"-Connector	Nero / Black	12,75
42674	Giunto "L"/"L"-Connector	Bianco / White	12,75
42675	Giunto "X"/"X"-Connector	Nero / Black	17,69
42676	Giunto "X"/"X"-Connector	Bianco / White	17,69
42677	Giunto "T"/"T"-Connector	Nero / Black	15,57
42678	Giunto "T"/"T"-Connector	Bianco / White	15,57
42679	Testate (2 Pcs.)/End-Caps	Nero / Black	5,67
42680	Testate (2 Pcs.)/End-Caps	Bianco / White	5,67
42681	Sospensione acciaio 2 mt (1 pz) / Steel cable 2 mt (1 pc)	n/a	9,67
42682	Sospensione e rosone ø115mm 2 mt (1 pz) / Suspension and canopy ø115mm 2 mt (1 pc)	Nero/Black	16,75
42685	Sospensione e rosone ø115mm 2 mt (1 pz) / Suspension and canopy ø115mm 2 mt (1 pc)	Bianco / White	16,75
42728	Attacco a soffitto/Ceiling bracket	n/a	5,67

STREAMLIGHT  
INCASSO



LED SAMSUNG  
CRI >82  
PF 0,9

CODE	FINISHING	WATT	LUMEN	BEAM	KELVIN	KG	PRICE
42730	Bianco/White	24W	2200	85**85°	3000K	0,40	46,73
42731	Bianco/White	24W	2400	85**85°	4000K	0,40	46,73

INSTALLAZIONE  
APPLICATION

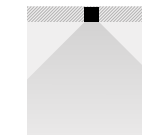

Incasso/Recessed

DISEGNI TECNICI  
TECHNICAL DRAWINGS

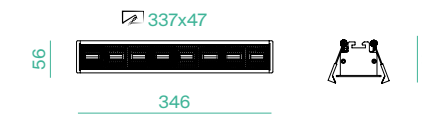

DRIVER

CODE	VOLT	CURRENT	PF	SIZE	MODE	PRICE
42732	24-42V	650mA	0,9	120x45x30	ON-OFF	25,96

## KLIK KLAK PROIETTORE

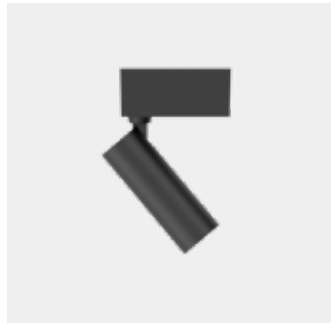

LED CREE  
CRI >90  
PF >0,7  
SDCM <3

CODE	FINISHING	WATT	LUMEN	WATT LIGHT SOURCE	LUMEN LIGHT SOURCE	BEAM	KELVIN	KG	PRICE
41111	Nero/Black	10W	749	8W	900	36°	3000K	0,35	90,85
41112	Bianco/White	10W	749	8W	900	36°	3000K	0,35	90,85
41179	Nero/Black	10W	870	8W	1100	36°	4000K	0,35	90,85
41192	Bianco/White	10W	870	8W	1100	36°	4000K	0,35	90,85
41772	Nero/Black	20W	1450	16W	1870	36°	3000K	0,78	135,45
41773	Bianco/White	20W	1450	16W	1870	36°	3000K	0,78	135,45

### INSTALLAZIONE APPLICATION

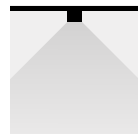

Binario magnetico/  
Magnetic track

### DISEGNI TECNICI TECHNICAL DRAWINGS

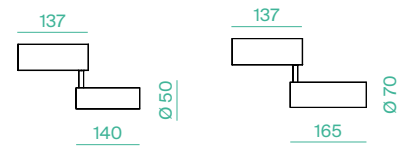

41111 41179  
41112 41192

### REGOLAZIONI ADJUSTABILITY



## KLIK KLAK PROIETTORE Q

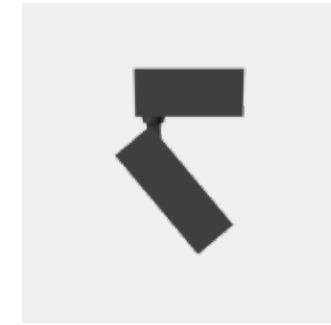

LED CREE  
CRI >90  
PF >0,5  
SDCM <3

CODE	FINISHING	WATT	LUMEN	WATT LIGHT SOURCE	LUMEN LIGHT SOURCE	BEAM	KELVIN	KG	PRICE
41770	Nero/Black	10W	749	8W	900	36°	3000K	0,52	96,60
41771	Bianco/White	10W	749	8W	900	36°	3000K	0,52	96,60

### INSTALLAZIONE APPLICATION

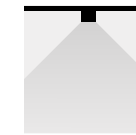

Binario magnetico/  
Magnetic track

### DISEGNI TECNICI TECHNICAL DRAWINGS

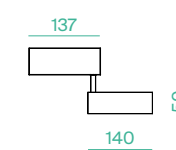

### REGOLAZIONI ADJUSTABILITY



## KLIK KLAK PROIETTORE

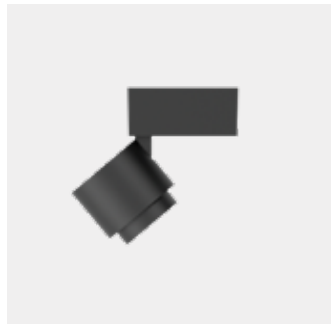

LED CREE  
CRI >90  
PF >0,7  
SDCM <3

CODE	FINISHING	WATT	LUMEN	WATT LIGHT SOURCE	LUMEN LIGHT SOURCE	BEAM	KELVIN	KG	PRICE
41176	Nero/Black	8W	404	6W	755	36°	3000K	0,42	96,75
41175	Bianco/White	8W	404	6W	755	36°	3000K	0,42	96,75
41178	Nero/Black	15W	904	12W	1395	36°	3000K	0,57	128,59
41177	Bianco/White	15W	904	12W	1395	36°	3000K	0,57	128,59
41214	Nero/Black	8W	483	6W	816	36°	4000K	0,42	96,75
41213	Bianco/White	8W	483	6W	816	36°	4000K	0,42	96,75
41216	Nero/Black	15W	957	12W	1477	36°	4000K	0,57	128,59
41215	Bianco/White	15W	957	12W	1477	36°	4000K	0,57	128,59

### INSTALLAZIONE APPLICATION

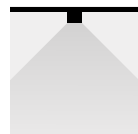

Binario magnetico/  
Magnetic track

### DISEGNI TECNICI TECHNICAL DRAWINGS

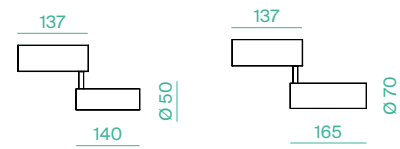

41111 41179  
41112 41192

### REGOLAZIONI ADJUSTABILITY



## KLIK KLAK GLOBO

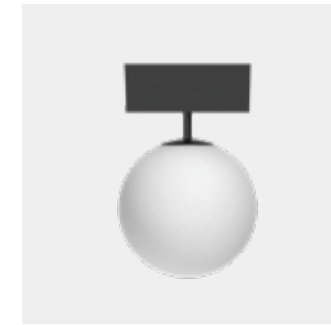

LED CREE  
CRI >90  
PF >0,5  
SDCM <3

CODE	FINISHING	WATT	LUMEN	WATT LIGHT SOURCE	LUMEN LIGHT SOURCE	BEAM	KELVIN	KG	PRICE
41778	Nero/Black	10W	680	8W	1105	DIFF.	3000K	0,46	86,10
41779	Bianco/White	10W	680	8W	1105	DIFF.	3000K	0,46	86,10

### INSTALLAZIONE APPLICATION

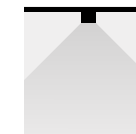

Binario magnetico/  
Magnetic track

### DISEGNI TECNICI TECHNICAL DRAWINGS

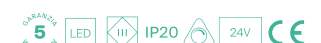
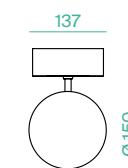

# KLIK\_KLAK PUNTIFORME

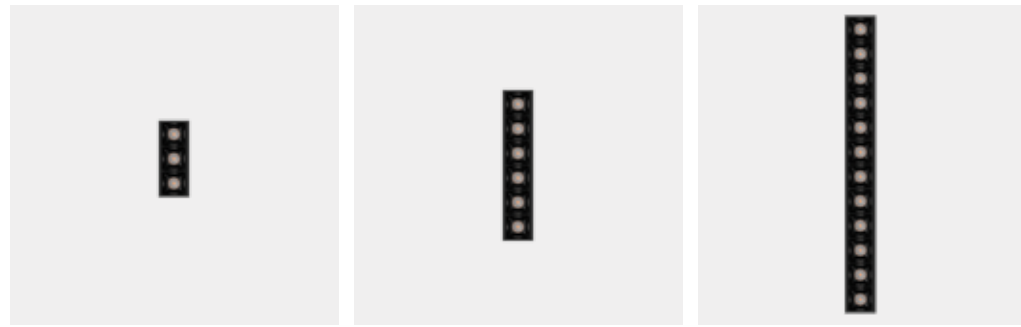

LED CREE  
CRI >90  
PF >0,7  
SDCM <3

CODE	FINISHING	WATT	LUMEN	WATT LIGHT SOURCE	LUMEN LIGHT SOURCE	BEAM	KELVIN	KG	PRICE
41119	Nero/Black	4W	375	3W	429	34°	3000K	0,16	47,19
41122	Bianco/White	4W	375	3W	429	34°	3000K	0,16	47,19
41120	Nero/Black	8W	788	6W	819	34°	3000K	0,28	66,07
41123	Bianco/White	8W	788	6W	819	34°	3000K	0,28	66,07
41121	Nero/Black	16W	1519	12W	1647	34°	3000K	0,40	116,80
41124	Bianco/White	16W	1519	12W	1647	34°	3000K	0,40	116,80
41199	Nero/Black	4W	381	3W	438	34°	4000K	0,16	47,19
41202	Bianco/White	4W	381	3W	438	34°	4000K	0,16	47,19
41200	Nero/Black	8W	741	6W	832	34°	4000K	0,28	66,07
41203	Bianco/White	8W	741	6W	832	34°	4000K	0,28	66,07
41201	Nero/Black	16W	1530	12W	1729	34°	4000K	0,40	116,80
41204	Bianco/White	16W	1530	12W	1729	34°	4000K	0,40	116,80

## INSTALLAZIONE APPLICATION



Binario magnetico/  
Magnetic track

## DISEGNI TECNICI TECHNICAL DRAWINGS



41199	41200	41201
41202	41203	41204
41119	41120	41121
41122	41123	41124



# KLIK\_KLAK PUNTIFORME ORIENTABILE



LED CREE  
CRI >90  
PF >0,7  
SDCM <3

CODE	FINISHING	WATT	LUMEN	WATT LIGHT SOURCE	LUMEN LIGHT SOURCE	BEAM	KELVIN	KG	PRICE
41125	Nero/Black	4W	375	3W	429	34°	3000K	0,49	116,80
41128	Bianco/White	4W	375	3W	429	34°	3000K	0,49	116,80
41126	Nero/Black	8W	788	6W	819	34°	3000K	0,88	152,19
41129	Bianco/White	8W	788	6W	819	34°	3000K	0,88	152,19
41127	Nero/Black	16W	1519	12W	1647	34°	3000K	1,30	234,78
41130	Bianco/White	16W	1519	12W	1647	34°	3000K	1,30	234,78
41205	Nero/Black	4W	381	3W	438	34°	4000K	0,49	116,80
41208	Bianco/White	4W	381	3W	438	34°	4000K	0,49	116,80
41206	Nero/Black	8W	741	6W	832	34°	4000K	0,88	152,19
41209	Bianco/White	8W	741	6W	832	34°	4000K	0,88	152,19
41207	Nero/Black	16W	1530	12W	1729	34°	4000K	1,30	234,78
41210	Bianco/White	16W	1530	12W	1729	34°	4000K	1,30	234,78

## INSTALLAZIONE APPLICATION



Binario magnetico/  
Magnetic track

## DISEGNI TECNICI TECHNICAL DRAWINGS

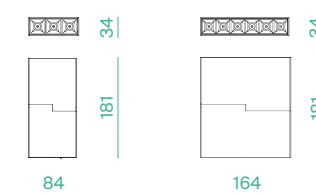

41205	41206
41208	41209
41125	41126
41128	41129

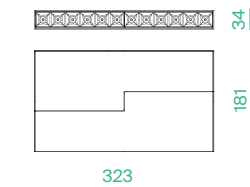

41207
41210
41127
41130

## REGOLAZIONI ADJUSTABILITY



# KLIK\_KLAK LUCÉ DIFFUSA

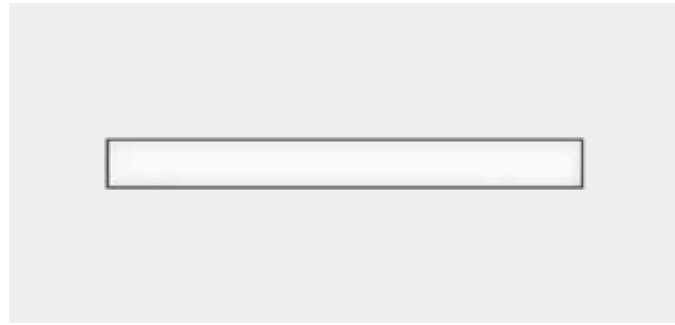

LED CREE  
CRI >90  
PF >0,7  
SDCM <3

CODE	FINISHING	WATT	LUMEN	WATT LIGHT SOURCE	LUMEN LIGHT SOURCE	BEAM	KELVIN	KG	PRICE
41113	Nero/Black	13W	962	10W	1560	105°	3000K	0,48	93,20
41116	Bianco/White	13W	962	10W	1560	105°	3000K	0,48	93,20
41114	Nero/Black	26W	1858	20W	3052	105°	3000K	0,96	163,99
41117	Bianco/White	26W	1858	20W	3052	105°	3000K	0,96	163,99
41115	Nero/Black	39W	2729	30W	4368	105°	3000K	1,44	234,78
41118	Bianco/White	39W	2729	30W	4368	105°	3000K	1,44	234,78
41193	Nero/Black	13W	965	10W	1638	105°	4000K	0,48	93,20
41196	Bianco/White	13W	965	10W	1638	105°	4000K	0,48	93,20
41194	Nero/Black	26W	2030	20W	3113	105°	4000K	0,96	163,99
41197	Bianco/White	26W	2030	20W	3113	105°	4000K	0,96	163,99
41195	Nero/Black	39W	2945	30W	4543	105°	4000K	1,44	234,78
41198	Bianco/White	39W	2945	30W	4543	105°	4000K	1,44	234,78

INSTALLAZIONE  
APPLICATION

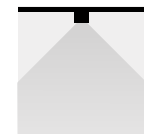

Binario magnetico/  
Magnetic track

DISEGNI TECNICI  
TECHNICAL DRAWINGS



41113 41193  
41116 41196

41114 41194  
41117 41197



41115 41195  
41118 41198



# KLIK\_KLAK SOSPENSIONE

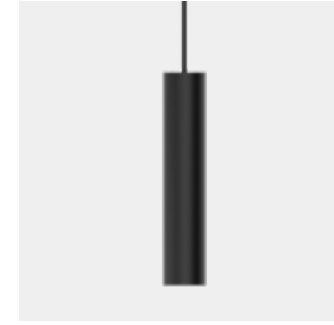

LED CREE  
CRI >90  
PF >0,5  
SDCM <3

CODE	FINISHING	WATT	LUMEN	WATT LIGHT SOURCE	LUMEN LIGHT SOURCE	BEAM	KELVIN	KG	PRICE
41174	Nero/Black	10W	749	8W	900	36°	3000K	0,56	105,00
41173	Bianco/White	10W	749	8W	900	36°	3000K	0,56	105,00
41212	Nero/Black	10W	870	8W	1100	36°	4000K	0,56	105,00
41211	Bianco/White	10W	870	8W	1100	36°	4000K	0,56	105,00

INSTALLAZIONE  
APPLICATION

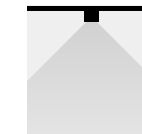

Binario magnetico/  
Magnetic track

DISEGNI TECNICI  
TECHNICAL DRAWINGS

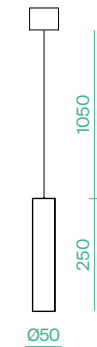

# KLIK\_KLAK SOSPENSIONE GLOBO



LED CREE  
CRI >90  
PF 0,5  
SDCM <3

CODE	FINISHING	WATT	LUMEN	WATT LIGHT SOURCE	LUMEN LIGHT SOURCE	BEAM	KELVIN	KG	PRICE
41774	Nero/Black	10W	680	8W	1105	DIFF.	3000K	0,50	90,30
41775	Bianco/White	10W	680	8W	1105	DIFF.	3000K	0,50	90,30

INSTALLAZIONE  
APPLICATION

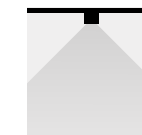

Binario magnetico/  
Magnetic track

DISEGNI TECNICI  
TECHNICAL DRAWINGS

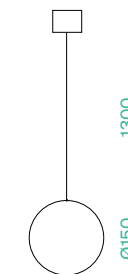

**KLIK\_KLAK**  
SOSPENSIONE  
BELL



LED CREE  
CRI >90  
PF >0,5  
SDCM <3

CODE	FINISHING	WATT	LUMEN	WATT LIGHT SOURCE	LUMEN LIGHT SOURCE	BEAM	KELVIN	KG	PRICE
41776	Nero/Black	10W	415,8	8W	900	65°	3000K	0,44	87,15
41777	Bianco/White	10W	571,9	8W	900	65°	3000K	0,44	87,15

INSTALLAZIONE  
APPLICATION

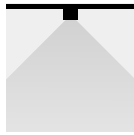

Binario magnetico/  
Magnetic track

DISEGNI TECNICI  
TECHNICAL DRAWINGS

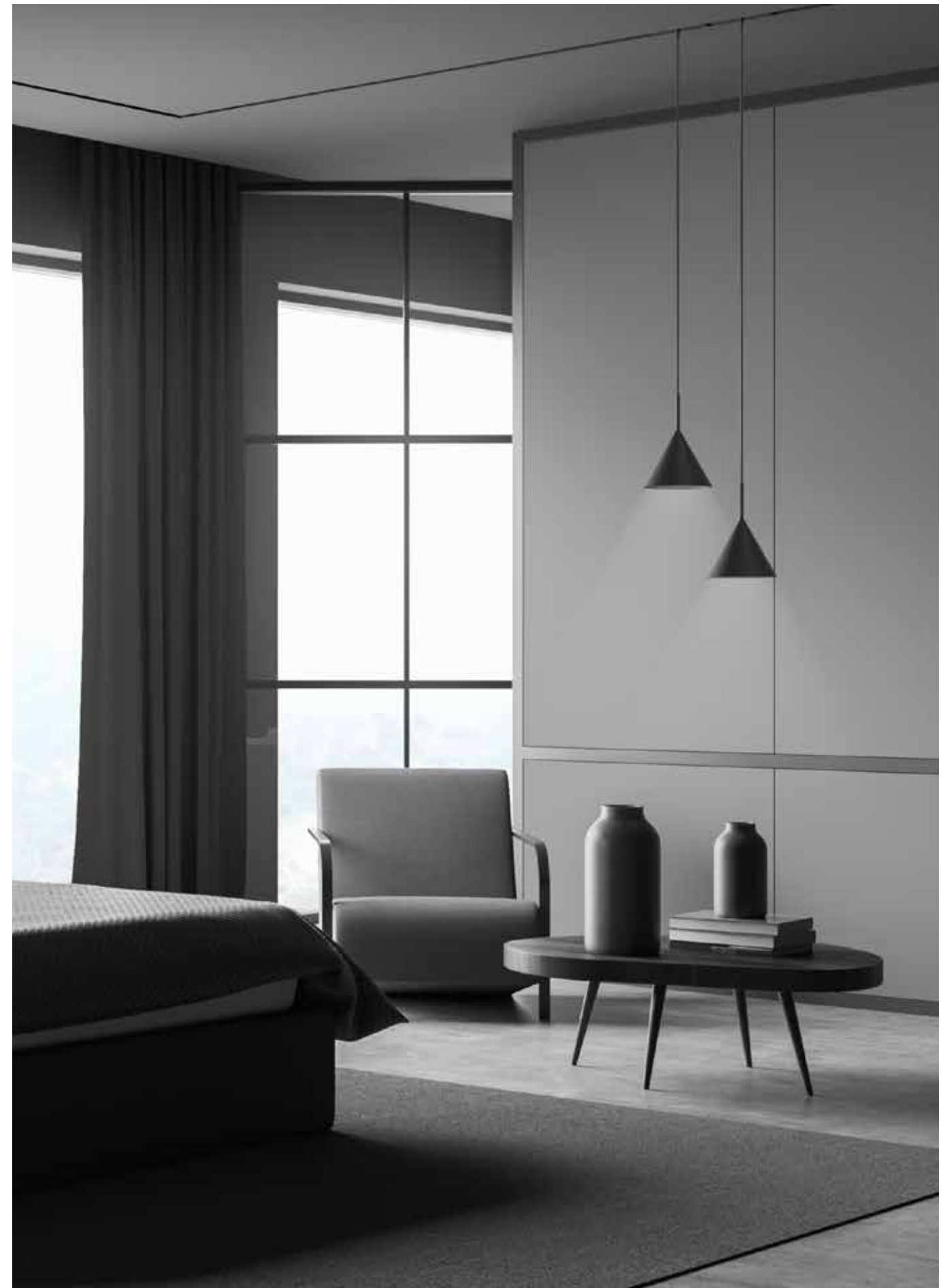
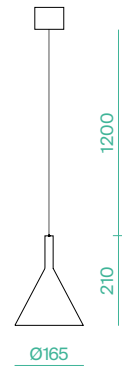

**KLIK\_KLAK**  
ACCESSORI  
ACCESSORIES

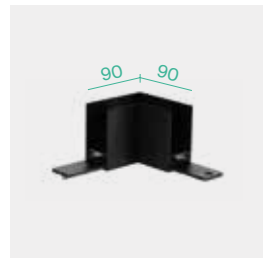

41136 - 41137

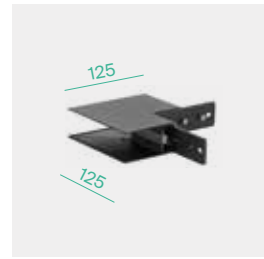

41138 - 41139

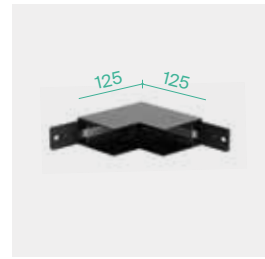

41140 - 41141

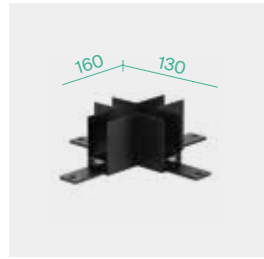

41257 - 41258

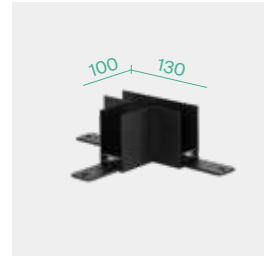

41259 - 41260



41142 - 41143

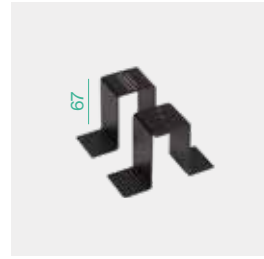

41131

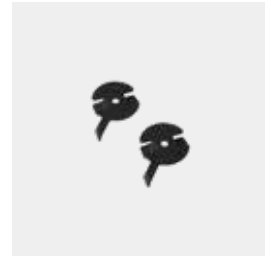

41222 - 41223



41132/A - 41133/A



41134 - 41135



41240 - 41241



42787 - 42784 - 42788 - 42785



42789 - 42786



42811 - 42808 - 42812 - 42809



42813 - 42810

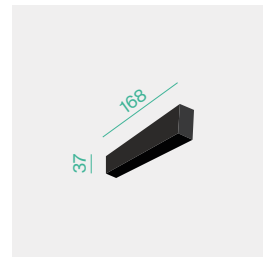

41782 - 41783

CODE	FINISHING	DESCRIPTION	KG	PRICE
41109	Nero / Black	Struttura 1mt in alluminio estruso con testate / 1mt extruded aluminium profile with end-caps	1,50	105,00
41110	Bianco / White	Struttura 1mt in alluminio estruso con testate / 1mt extruded aluminium profile with end-caps	1,50	105,00
41144	Nero / Black	Struttura 2mt in alluminio estruso con testate / 2mt extruded aluminium profile with end-caps	3,00	210,00
41145	Bianco / White	Struttura 2mt in alluminio estruso con testate / 2mt extruded aluminium profile with end-caps	3,00	210,00
41146	Nero / Black	Copertura per rasatura 1 mt / 1 mt mask for plasterboard thinning		6,49
41136	Nero / Black	Angolo 90° e accessori / 90° corner with accessories		51,91
41137	Bianco / White	Angolo 90° e accessori / 90° corner with accessories		51,91
41138	Nero / Black	Angolo 90° esterno e accessori / Outer 90° corner with accessories		51,91
41139	Bianco / White	Angolo 90° esterno e accessori / Outer 90° corner with accessories		51,91
41140	Nero / Black	Angolo 90° interno e accessori / Inner 90° corner with accessories		51,91
41141	Bianco / White	Angolo 90° interno e accessori / Inner 90° corner with accessories		51,91

**KLIK\_KLAK**  
ACCESSORI  
ACCESSORIES

CODE	FINISHING	DESCRIPTION	KG	PRICE
41142	Nero / Black	Congiunzione elettrica con spinotti / Linear 65mm electric connection with relative 3-pins connector		8,26
41143	Bianco / White	Congiunzione elettrica con spinotti / Linear 65mm electric connection with relative 3-pins connector		8,26
41131	Nero / Black	Kit staffe incasso (2 pz) / Brackets for recessed installation (2 pcs)		12,98
41222	Nero / Black	Staffe attacco soffitto kit 2pz / Brackets for ceiling installation 2 pcs		8,14
41223	Bianco / White	Staffe attacco soffitto kit 2pz / Brackets for ceiling installation 2 pcs		8,14
41132	Acciaio/Steel	Sospensione 2mt (1 pz) / Suspension 2mt (1 pc)		12,39
41132/A	Nero / Black	Sospensione con cavo alimentazione 2mt (1 pz) / Suspension 2mt with electrical wire (1 pc)		12,39
41133/A	Bianco / White	Sospensione con cavo alimentazione 2mt (1 pz) / Suspension 2mt with electrical wire (1 pc)		12,39
41134	Nero / Black	Staffa connessione (1 pz) / Linear connection plate (1 pc)		4,71
41135	Bianco / White	Staffa connessione (1 pz) / Linear connection plate (1 pc)		4,71
41258	Nero / Black	Giunto a "X"/"X" connector		57,81
41257	Bianco / White	Giunto a "X"/"X" connector		57,81
41260	Nero / Black	Giunto a "T"/"T" connector		57,81
41259	Bianco / White	Giunto a "T"/"T" connector		57,81
41241	Nero / Black	Testata per alimentazione 24V/Front feed 24V		19,47
41240	Bianco / White	Testata per alimentazione 24V/Front feed 24V		19,47
41782	Nero / Black	Ponte di giunzione elettrica 168mm H.37mm/Electric bridge connector 168mm H.37mm		25,46
41783	Bianco / White	Ponte di giunzione elettrica 168mm H.37mm/Electric bridge connector 168mm H.37mm		25,46
42787	Nero / Black	Testata c/ driver 75W 230V dimm./Front feed w/ driver 75W 230V dimm.	0,70	175,79
42784	Bianco / White	Testata c/ driver 75W 230V dimm./Front feed w/ driver 75W 230V dimm.	0,70	175,79
42788	Nero / Black	Testata c/ driver 100W 230V dimm./Front feed w/ driver 100W 230V dimm.	0,70	192,31
42785	Bianco / White	Testata c/ driver 100W 230V dimm./Front feed w/ driver 100W 230V dimm.	0,70	192,31
42789	Nero / Black	Testata c/ driver 150W 230V dimm./Front feed w/ driver 150W 230V dimm.	0,80	234,78
42786	Bianco / White	Testata c/ driver 150W 230V dimm./Front feed w/ driver 150W 230V dimm.	0,80	234,78
42811	Nero / Black	Centrale c/ driver 75W 230V dimm./Central feed w/ driver 75W 230V dimm.	0,72	180,60
42808	Bianco / White	Centrale c/ driver 75W 230V dimm./Central feed w/ driver 75W 230V dimm.	0,72	180,60
42812	Nero / Black	Centrale c/ driver 100W 230V dimm./Central feed w/ driver 100W 230V dimm.	0,72	197,40
42809	Bianco / White	Centrale c/ driver 100W 230V dimm./Central feed w/ driver 100W 230V dimm.	0,72	197,40
42813	Nero / Black	Centrale c/ driver 150W 230V dimm./Central feed w/ driver 150W 230V dimm.	0,82	239,40
42810	Bianco / White	Centrale c/ driver 150W 230V dimm./Central feed w/ driver 150W 230V dimm.	0,82	239,40

**DRIVER**

CODE	WATT	VOLT	DESCRIPTION	MODE	SIZE	PRICE
22015	50W	24V DC	Driver MW	ON-OFF	99x82x30mm	34,45
22031	60W	24V DC	Driver EAGLERISE TRP	ON-OFF	187x45x31mm	39,69
22032	75W	24V DC	Driver EAGLERISE TRP	ON-OFF	187x45x31mm	50,72
22016	100W	24V DC	Driver MW	ON-OFF	129x97x30mm	61,74
22033	120W	24V DC	Driver EAGLERISE TRP	ON-OFF	268x45x31mm	65,05
22034	150W	24V DC	Driver EAGLERISE TRP	ON-OFF	268x45x31mm	83,79
22025	150W	24V DC	Driver MW	ON-OFF	160x95x30mm	65,05
22017	200W	24V DC	Driver MW	ON-OFF	215x115x30mm	132,30
41217	75W	24V DC	Driver dimmerabile LTECH	0-10V	144x78x38.5mm	149,14
41218	100W	24V DC	Driver dimmerabile LTECH	0-10V	240x70x36mm	164,72
41219	150W	24V DC	Driver dimmerabile LTECH	0-10V	270x79x39mm	208,13
11044	75W	24V DC	Driver LTECH	DALI	290x45x30mm	213,12
11045	150W	24V DC	Driver LTECH	DALI	290x45x30mm	292,62

## KLIK\_KLAK MINI PROIETTORE

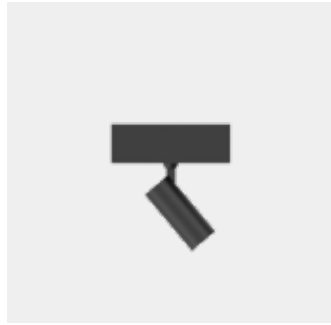

LED CREE  
CRI >90  
PF >0,5  
SDCM <3

CODE	FINISHING	WATT	LUMEN	WATT LIGHT SOURCE	LUMEN LIGHT SOURCE	BEAM	KELVIN	KG	PRICE
41733	Nero/Black	6W	423	5W	630	30°	3000K	0,26	81,90
41734	Bianco/White	6W	423	5W	630	30°	3000K	0,26	81,90

### INSTALLAZIONE APPLICATION

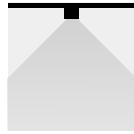

Binario magnetico/  
Magnetic track

### DISEGNI TECNICI TECHNICAL DRAWINGS

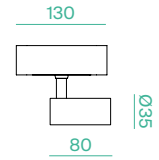

### REGOLAZIONI ADJUSTABILITY



## KLIK\_KLAK MINI GLOBO

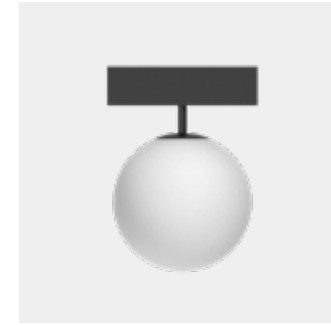

LED CREE  
CRI >90  
PF >0,5  
SDCM <3

CODE	FINISHING	WATT	LUMEN	WATT LIGHT SOURCE	LUMEN LIGHT SOURCE	BEAM	KELVIN	KG	PRICE
41745	Nero/Black	10W	680	8W	1105	DIFF.	3000K	0,46	86,10
41746	Bianco/White	10W	680	8W	1105	DIFF.	3000K	0,46	86,10

### INSTALLAZIONE APPLICATION

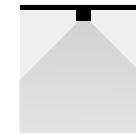

Binario magnetico/  
Magnetic track

### DISEGNI TECNICI TECHNICAL DRAWINGS

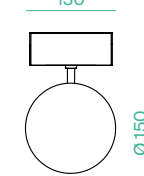

## KLIK\_KLAK MINI PROIETTORE

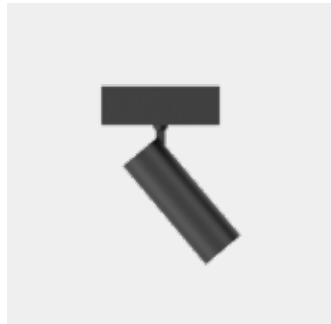

LED CREE  
CRI >90  
PF >0,5  
SDCM <3

CODE	FINISHING	WATT	LUMEN	WATT LIGHT SOURCE	LUMEN LIGHT SOURCE	BEAM	KELVIN	KG	PRICE
41735	Nero/Black	10W	749	8W	900	36°	3000K	0,35	85,70
41736	Bianco/White	10W	749	8W	900	36°	3000K	0,35	85,70

### INSTALLAZIONE APPLICATION

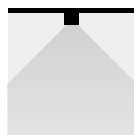

Binario magnetico/  
Magnetic track

### DISEGNI TECNICI TECHNICAL DRAWINGS

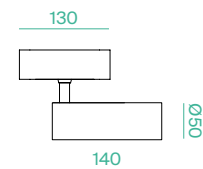

### REGOLAZIONI ADJUSTABILITY



## KLIK\_KLAK MINI PUNTIFORME

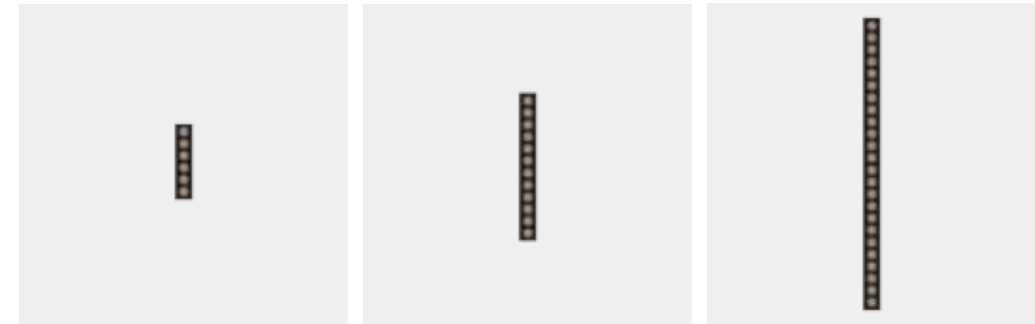

LED CREE  
CRI >90  
PF >0,7  
SDCM <3

CODE	FINISHING	WATT	LUMEN	WATT LIGHT SOURCE	LUMEN LIGHT SOURCE	BEAM	KELVIN	KG	PRICE
41717	Nero/Black	6W	509	5W	693	30°	3000K	0,12	46,20
41718	Bianco/White	6W	509	5W	693	30°	3000K	0,12	46,20
41719	Nero/Black	12W	1011	10W	1410	30°	3000K	0,18	80,85
41720	Bianco/White	12W	1011	10W	1410	30°	3000K	0,18	80,85
41721	Nero/Black	24W	2041	20W	2750	30°	3000K	0,36	142,80
41722	Bianco/White	24W	2041	20W	2750	30°	3000K	0,36	142,80

### INSTALLAZIONE APPLICATION



Binario magnetico/  
Magnetic track

### DISEGNI TECNICI TECHNICAL DRAWINGS

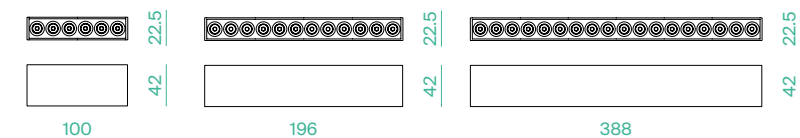

41717  
41718

41719  
41720

41721  
41722



# KLIK\_KLAK MINI PUNIFORME ORIENTABILE

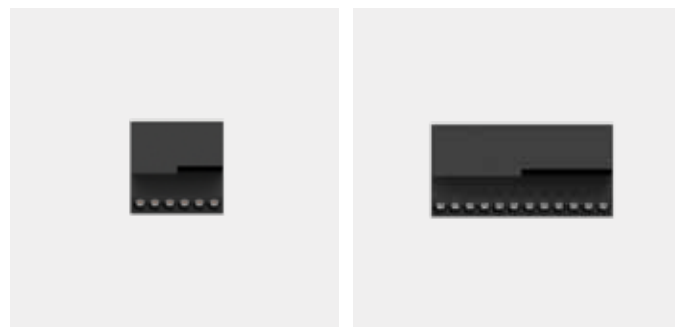

LED CREE  
CRI >90  
PF >0,7  
SDCM <3

CODE	FINISHING	WATT	LUMEN	WATT LIGHT SOURCE	LUMEN LIGHT SOURCE	BEAM	KELVIN	KG	PRICE
41729	Nero/Black	8W	681	6W	819	30°	3000K	0,24	109,20
41730	Bianco/White	8W	681	6W	819	30°	3000K	0,24	109,20
41731	Nero/Black	16W	1198	12W	1647	30°	3000K	0,48	166,95
41732	Bianco/White	16W	1198	12W	1647	30°	3000K	0,48	166,95

## INSTALLAZIONE APPLICATION

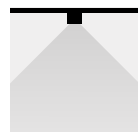

Binario magnetico/  
Magnetic track

## DISEGNI TECNICI TECHNICAL DRAWINGS

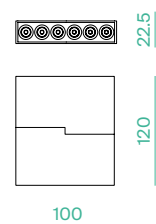

41729  
41730

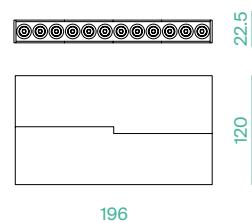

41731  
41732

## REGOLAZIONI ADJUSTABILITY



# KLIK\_KLAK MINI LUCÉ DIFFUSA

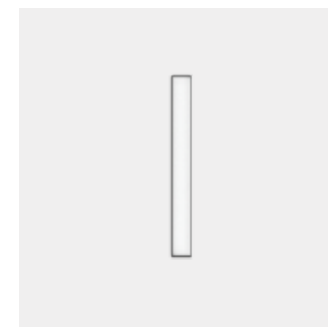

LED CREE  
CRI >90  
PF >0,7  
SDCM <3

CODE	FINISHING	WATT	LUMEN	WATT LIGHT SOURCE	LUMEN LIGHT SOURCE	BEAM	KELVIN	KG	PRICE
41723	Nero/Black	8W	605	6W	950	105°	3000K	0,19	65,10
41724	Bianco/White	8W	605	6W	950	105°	3000K	0,19	65,10
41725	Nero/Black	15W	1013	12W	1900	105°	3000K	0,32	114,45
41726	Bianco/White	15W	1013	12W	1900	105°	3000K	0,32	114,45
41727	Nero/Black	30W	1970	23W	3420	105°	3000K	0,66	166,95
41728	Bianco/White	30W	1970	23W	3420	105°	3000K	0,66	166,95

## INSTALLAZIONE APPLICATION



Binario magnetico/  
Magnetic track

## DISEGNI TECNICI TECHNICAL DRAWINGS

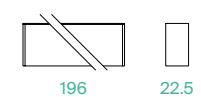

41723  
41724

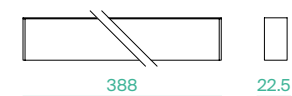

41725  
41726

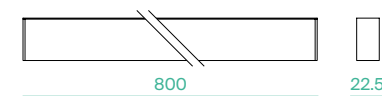

41727  
41728



## KLIK\_KLAK MINI SOSPENSIONE



LED CREE  
CRI >90  
PF >0,5  
SDCM <3

CODE	FINISHING	WATT	LUMEN	WATT LIGHT SOURCE	LUMEN LIGHT SOURCE	BEAM	KELVIN	KG	PRICE
41739	Nero/Black	6W	423	5W	630	30°	3000K	0,48	96,60
41740	Bianco/White	6W	423	5W	630	30°	3000K	0,48	96,60
41737	Nero/Black	10W	749	8W	900	36°	3000K	0,56	99,06
41738	Bianco/White	10W	749	8W	900	36°	3000K	0,56	99,06

### INSTALLAZIONE APPLICATION

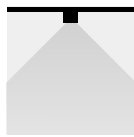

Binario magnetico/  
Magnetic track

### DISEGNI TECNICI TECHNICAL DRAWINGS

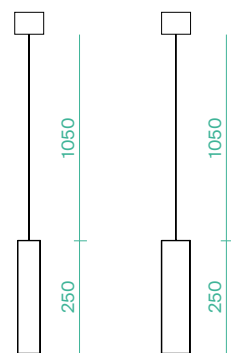

Ø35

41739  
41740

Ø50

41737  
41738



## KLIK\_KLAK MINI SOSPENSIONE GLOBO



LED CREE  
CRI >90  
PF >0,5  
SDCM <3

CODE	FINISHING	WATT	LUMEN	WATT LIGHT SOURCE	LUMEN LIGHT SOURCE	BEAM	KELVIN	KG	PRICE
41741	Nero/Black	10W	680	8W	1105	DIFF.	3000K	0,50	90,30
41742	Bianco/White	10W	680	8W	1105	DIFF.	3000K	0,50	90,30

### INSTALLAZIONE APPLICATION

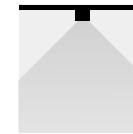

Binario magnetico/  
Magnetic track

### DISEGNI TECNICI TECHNICAL DRAWINGS



## KLIK\_KLAK MINI SOSPENSIONE BELL



LED CREE  
CRI >90  
PF >0,5  
SDCM <3

CODE	FINISHING	WATT	LUMEN	WATT LIGHT SOURCE	LUMEN LIGHT SOURCE	BEAM	KELVIN	KG	PRICE
41743	Nero/Black	10W	415	8W	900	65°	3000K	0,44	87,15
41744	Bianco/White	10W	571	8W	900	65°	3000K	0,44	87,15

### INSTALLAZIONE APPLICATION



Binario magnetico/  
Magnetic track

### DISEGNI TECNICI TECHNICAL DRAWINGS

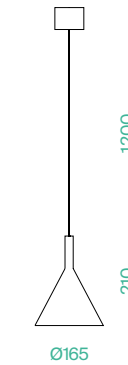

# KLIK\_KLAK MINI ACCESSORI ACCESSORIES

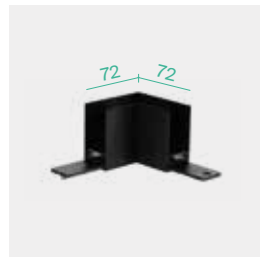

41747 - 41748

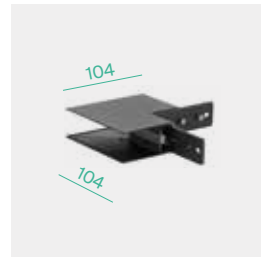

41751 - 41752



41749 - 41750

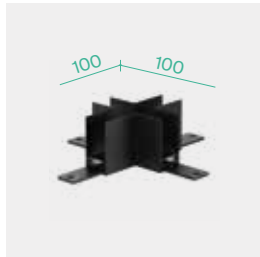

41753 - 41754

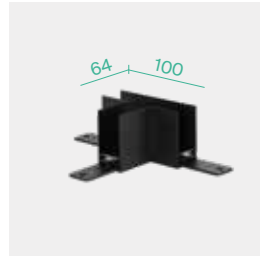

41755 - 41756



41759 - 41760

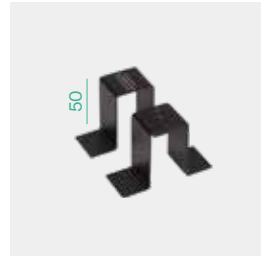

41763



41761 - 41762



41132/A - 41133/A



41757 - 41758



41765 - 41766



41784 - 41788



41785 - 41789 - 41786 - 41790



42817 - 42814



42818 - 42815 - 42819 - 42816

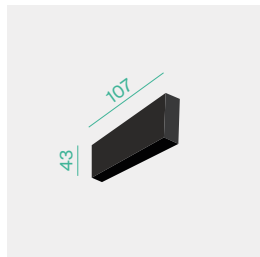

41780 - 41781

# KLIK\_KLAK MINI ACCESSORI ACCESSORIES

CODE	FINISHING	DESCRIPTION	KG	PRICE
41764	Nero / Black	Copertura per rasatura 1 mt / 1 mt mask for plasterboard thinning		6,12
41747	Nero / Black	Angolo 90° con spinotti e accessori / 90° corner with accessories		48,30
41748	Bianco / White	Angolo 90° con spinotti e accessori / 90° corner with accessories		48,30
41751	Nero / Black	Angolo 90° esterno e accessori / Outer 90° corner with accessories		48,30
41752	Bianco / White	Angolo 90° esterno e accessori / Outer 90° corner with accessories		48,30
41749	Nero / Black	Angolo 90° interno e accessori / Inner 90° corner with accessories		48,30
41750	Bianco / White	Angolo 90° interno e accessori / Inner 90° corner with accessories		48,30
41759	Nero / Black	Congiunzione elettrica con spinotti / Linear electric connection with relative 3-pins connector		7,35
41760	Bianco / White	Congiunzione elettrica con spinotti / Linear electric connection with relative 3-pins connector		7,35
41763	Nero / Black	Kit staffe incasso (2 pz) / Brackets for recessed installation (2 pcs)		12,24
41761	Nero / Black	Staffe attacco soffitto kit 2pz / Brackets for ceiling installation 2 pcs		7,68
41762	Bianco / White	Staffe attacco soffitto kit 2pz / Brackets for ceiling installation 2 pcs		7,68
41132	Acciaio/Steel	Sospensione 2mt (1 pz) / Suspension 2mt (1 pc)		12,39
41132/A	Nero / Black	Sospensione con cavo alimentazione 2mt (1 pz) / Suspension 2mt with electrical wire (1 pc)		12,39
41133/A	Bianco / White	Sospensione con cavo alimentazione 2mt (1 pz) / Suspension 2mt with electrical wire (1 pc)		12,39
41757	Nero / Black	Staffa connessione (1 pz) / Linear connection plate (1 pc)		4,20
41758	Bianco / White	Staffa connessione (1 pz) / Linear connection plate (1 pc)		4,20
41753	Nero / Black	Giunto a "X"/"X" connector		53,55
41754	Bianco / White	Giunto a "X"/"X" connector		53,55
41755	Nero / Black	Giunto a "T"/"T" connector		53,55
41756	Bianco / White	Giunto a "T"/"T" connector		53,55
41765	Nero / Black	Testata per alimentazione 24V / Front feed 24V		18,36
41766	Bianco / White	Testata per alimentazione 24V / Front feed 24V		18,36
41780	Nero / Black	Ponte di giunzione elettrica 107mm H.43mm / Electric bridge connector 107mm H.43mm		25,46
41781	Bianco / White	Ponte di giunzione elettrica 107mm H.43mm / Electric bridge connector 107mm H.43mm		25,46
41784	Nero / Black	Testata c/ driver 60W 230V dimm. / Front feed w/ driver 60W 230V dimm.	0,70	161,70
41788	Bianco / White	Testata c/ driver 60W 230V dimm. / Front feed w/ driver 60W 230V dimm.	0,70	161,70
41785	Nero / Black	Testata c/ driver 100W 230V dimm. / Front feed w/ driver 100W 230V dimm.	0,80	216,30
41789	Bianco / White	Testata c/ driver 100W 230V dimm. / Front feed w/ driver 100W 230V dimm.	0,80	216,30
41786	Nero / Black	Testata c/ driver 150W 230V dimm. / Front feed w/ driver 150W 230V dimm.	0,80	266,70
41790	Bianco / White	Testata c/ driver 150W 230V dimm. / Front feed w/ driver 150W 230V dimm.	0,80	266,70
42817	Nero / Black	Centrale c/ driver 60W 230V dimm. / Central feed w/ driver 60W 230V dimm.	0,72	166,95
42814	Bianco / White	Centrale c/ driver 60W 230V dimm. / Central feed w/ driver 60W 230V dimm.	0,72	166,95
42818	Nero / Black	Centrale c/ driver 100W 230V dimm. / Central feed w/ driver 100W 230V dimm.	0,82	222,60
42815	Bianco / White	Centrale c/ driver 100W 230V dimm. / Central feed w/ driver 100W 230V dimm.	0,82	222,60
42819	Nero / Black	Centrale c/ driver 150W 230V dimm. / Central feed w/ driver 150W 230V dimm.	0,82	271,95
42816	Bianco / White	Centrale c/ driver 150W 230V dimm. / Central feed w/ driver 150W 230V dimm.	0,82	271,95

CODE	FINISHING	DESCRIPTION	KG	PRICE
41713	Nero / Black	Struttura 1mt in alluminio estruso con testate / 1mt extruded aluminium profile with end-caps	1,14	85,05
41714	Bianco / White	Struttura 1mt in alluminio estruso con testate / 1mt extruded aluminium profile with end-caps	1,14	85,05
41715	Nero / Black	Struttura 2mt in alluminio estruso con testate / 2mt extruded aluminium profile with end-caps	2,28	170,10
41716	Bianco / White	Struttura 2mt in alluminio estruso con testate / 2mt extruded aluminium profile with end-caps	2,28	170,10

## DRIVER

CODE	WATT	VOLT	DESCRIPTION	MODE	SIZE	PRICE
22015	50W	24V DC	Driver MW	ON-OFF	99x82x30mm	34,45
22031	60W	24V DC	Driver EAGLERISE TRP	ON-OFF	187x45x31mm	39,69
22032	75W	24V DC	Driver EAGLERISE TRP	ON-OFF	187x45x31mm	50,72
22016	100W	24V DC	Driver MW	ON-OFF	129x97x30mm	61,74
22033	120W	24V DC	Driver EAGLERISE TRP	ON-OFF	268x45x31mm	65,05
22034	150W	24V DC	Driver EAGLERISE TRP	ON-OFF	268x45x31mm	83,79
22025	150W	24V DC	Driver MW	ON-OFF	160x95x30mm	65,05
22017	200W	24V DC	Driver MW	ON-OFF	215x115x30mm	132,30
41217	75W	24V DC	Driver dimmerabile LTECH	0-10V	144x78x38.5mm	149,14
41218	100W	24V DC	Driver dimmerabile LTECH	0-10V	240x70x36mm	164,72
41219	150W	24V DC	Driver dimmerabile LTECH	0-10V	270x79x39mm	208,13
11044	75W	24V DC	Driver LTECH	DALI	290x45x30mm	213,12
11045	150W	24V DC	Driver LTECH	DALI	290x45x30mm	292,62

# KLIK\_KLAK\_MICRO PROIETTORE

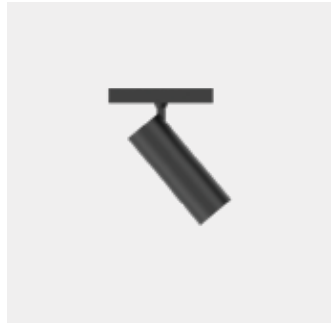

LED CREE  
CRI >90  
PF >0,5  
SDCM <3

CODE	FINISHING	WATT	LUMEN	WATT LIGHT SOURCE	LUMEN LIGHT SOURCE	BEAM	KELVIN	KG	PRICE
42835	Nero/Black	6W	423	5W	630	30°	3000K	0,20	81,90
42836	Bianco/White	6W	423	5W	630	30°	3000K	0,20	81,90
42837	Nero/Black	10W	749	8W	900	36°	3000K	0,20	85,70
42838	Bianco/White	10W	749	8W	900	36°	3000K	0,20	85,70

## INSTALLAZIONE APPLICATION

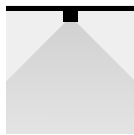

Binario magnetico/  
Magnetic track

## DISEGNI TECNICI TECHNICAL DRAWINGS

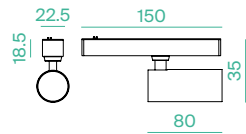

42835  
42836

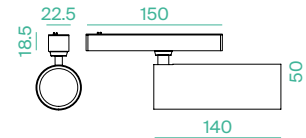

42837  
42838

## REGOLAZIONI ADJUSTABILITY



# KLIK\_KLAK\_MICRO LUCÈ DIFFUSA

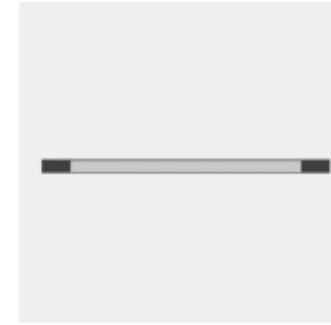

LED CREE  
CRI >90  
PF >0,7  
SDCM <3

CODE	FINISHING	WATT	LUMEN	WATT LIGHT SOURCE	LUMEN LIGHT SOURCE	BEAM	KELVIN	KG	PRICE
42829	Nero/Black	12W	862	9W	1393	105°	3000K	0,25	109,00
42830	Bianco/White	12W	862	9W	1393	105°	3000K	0,25	109,00
42831	Nero/Black	18W	1270	14W	2067	105°	3000K	0,25	132,00
42832	Bianco/White	18W	1270	14W	2067	105°	3000K	0,25	132,00
42833	Nero/Black	24W	1705	18W	2752	105°	3000K	0,25	169,00
42834	Bianco/White	24W	1705	18W	2752	105°	3000K	0,25	169,00

## INSTALLAZIONE APPLICATION

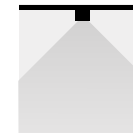

Binario magnetico/  
Magnetic track

## DISEGNI TECNICI TECHNICAL DRAWINGS

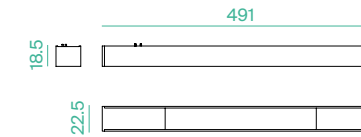

42829  
42830

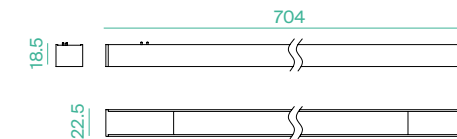

42831  
42832

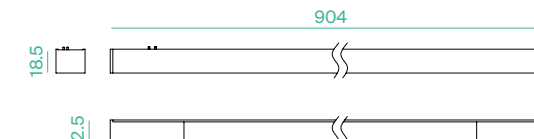

42833  
42834

## KLIK\_KLAK\_MICRO PUNTIFORME



LED CREE  
CRI >90  
PF >0,7  
SDCM <3

CODE	FINISHING	WATT	LUMEN	WATT LIGHT SOURCE	LUMEN LIGHT SOURCE	BEAM	KELVIN	KG	PRICE
42825	Nero/Black	12W	1011	10W	1410	30°	3000K	0,15	71,00
42826	Bianco/White	12W	1011	10W	1410	30°	3000K	0,15	71,00
42827	Nero/Black	24W	2041	20W	2750	30°	3000K	0,15	129,00
42828	Bianco/White	24W	2041	20W	2750	30°	3000K	0,15	129,00

### INSTALLAZIONE APPLICATION

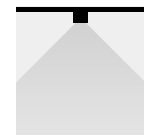

Binario magnetico/  
Magnetic track

### DISEGNI TECNICI TECHNICAL DRAWINGS

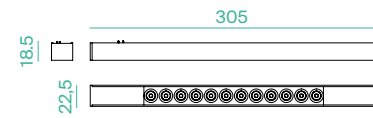

42825  
42826

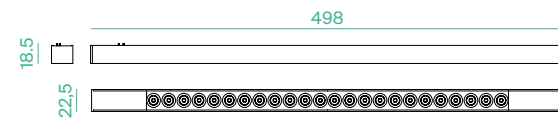

42827  
42828

## KLIK\_KLAK\_MICRO SOSPENSIONE

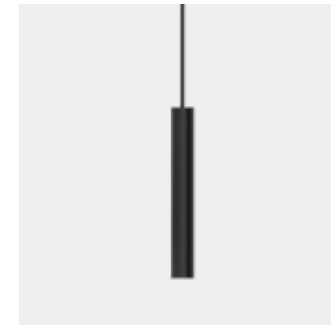

LED CREE  
CRI >90  
PF >0,5  
SDCM <3

CODE	FINISHING	WATT	LUMEN	WATT LIGHT SOURCE	LUMEN LIGHT SOURCE	BEAM	KELVIN	KG	PRICE
42839	Nero/Black	6W	423	5W	630	30°	3000K	0,45	96,60
42840	Bianco/White	6W	423	5W	630	30°	3000K	0,45	96,60

### INSTALLAZIONE APPLICATION

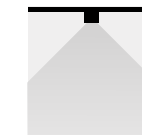

Binario magnetico/  
Magnetic track

### DISEGNI TECNICI TECHNICAL DRAWINGS

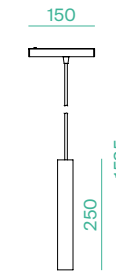

## KLIK\_KLAK\_MICRO SOSPENSIONE BELL



LED CREE  
CRI >90  
PF >0,5  
SDCM <3

CODE	FINISHING	WATT	LUMEN	WATT LIGHT SOURCE	LUMEN LIGHT SOURCE	BEAM	KELVIN	KG	PRICE
42841	Nero/Black	10W	415	8W	900	65°	3000K	0,40	87,15
42842	Bianco/White	10W	571	8W	900	65°	3000K	0,40	87,15

### INSTALLAZIONE APPLICATION

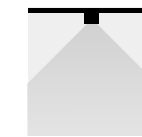

Binario magnetico/  
Magnetic track

### DISEGNI TECNICI TECHNICAL DRAWINGS

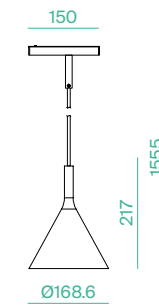

## KLIK\_KLAK MICRO ACCESSORI ACCESSORIES

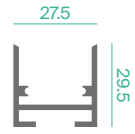

42843 - 42844



42845 - 42846

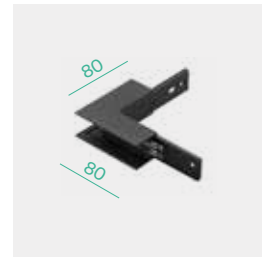

42847 - 42848

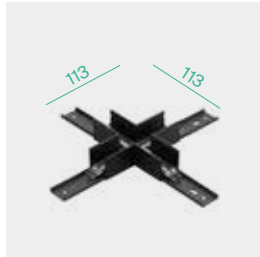

42849 - 42850

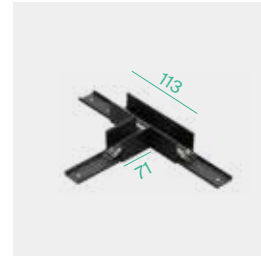

42851 - 42852

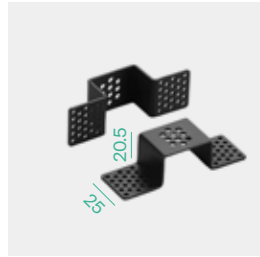

42853

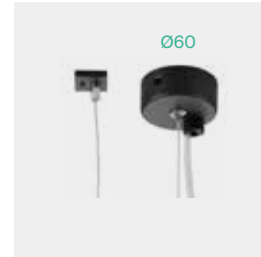

42854 - 42855

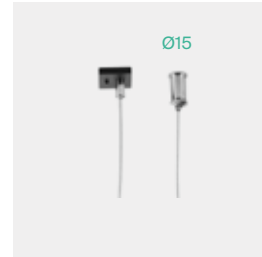

42856 - 42857

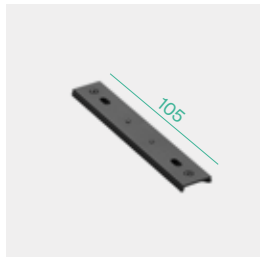

42858-42859



41759 - 41760



42862-42863

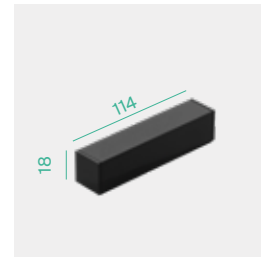

42864-42865

CODE	FINISHING	DESCRIPTION	KG	PRICE
42821	Nero / Black	Struttura 1mt in alluminio estruso con testate/ 1mt extruded aluminium profile with end-caps	0,80	69,00
42822	Bianco / White	Struttura 1mt in alluminio estruso con testate/ 1mt extruded aluminium profile with end-caps	0,80	69,00
42823	Nero / Black	Struttura 2mt in alluminio estruso con testate/ 2mt extruded aluminium profile with end-caps	1,55	136,00
42824	Bianco / White	Struttura 2mt in alluminio estruso con testate/ 2mt extruded aluminium profile with end-caps	1,55	136,00

## KLIK\_KLAK MICRO ACCESSORI ACCESSORIES

CODE	FINISHING	DESCRIPTION	PRICE
42843	Nero / Black	Angolo 90° con spinotti e accessori/ 90° corner with accessories	46,50
42844	Bianco / White	Angolo 90° con spinotti e accessori/ 90° corner with accessories	46,50
42845	Nero / Black	Angolo 90° interno e accessori/ Inner 90° corner with accessories	46,50
42846	Bianco / White	Angolo 90° interno e accessori/ Inner 90° corner with accessories	46,50
42847	Nero / Black	Angolo 90° esterno e accessori/ Outer 90° corner with accessories	46,50
42848	Bianco / White	Angolo 90° esterno e accessori/ Outer 90° corner with accessories	46,50
42849	Nero / Black	Giunto a "X"/"X" connector	51,20
42850	Bianco / White	Giunto a "X"/"X" connector	51,20
42851	Nero / Black	Giunto a "T"/"T" connector	51,20
42852	Bianco / White	Giunto a "T"/"T" connector	51,20
42853	Nero / Black	Kit staffe incasso (2 pz) / Brackets for recessed installation (2 pcs)	11,50
42854	Nero / Black	Sospensione con cavo alimentazione 2mt (1 pz) / Suspension 2mt with electrical wire (1 pc)	12,39
42855	Bianco / White	Sospensione con cavo alimentazione 2mt (1 pz) / Suspension 2mt with electrical wire (1 pc)	12,39
42856	Nero / Black	Sospensione 2mt (1 pz) / Suspension 2mt (1 pc)	12,39
42857	Bianco / White	Sospensione 2mt (1 pz) / Suspension 2mt (1 pc)	12,39
42858	Nero / Black	Staffa connessione (1 pz) / Linear connection plate (1 pc)	4,20
42859	Bianco / White	Staffa connessione (1 pz) / Linear connection plate (1 pc)	4,20
41759	Nero / Black	Congiunzione elettrica con spinotti/ Linear electric connection with relative 3-pins connector	7,35
41760	Bianco / White	Congiunzione elettrica con spinotti/ Linear electric connection with relative 3-pins connector	7,35
42862	Nero / Black	Staffe attacco soffitto kit 2pz / Brackets for ceiling installation 2 pcs	7,68
42863	Bianco / White	Staffe attacco soffitto kit 2pz / Brackets for ceiling installation 2 pcs	7,68
42864	Nero / Black	Ponte di giunzione elettrica 114mm H.18mm/ Electric bridge connector 114mm H.18mm	25,46
42865	Bianco / White	Ponte di giunzione elettrica 114mm H.18mm/ Electric bridge connector 114mm H.18mm	25,46
41764	Nero / Black	Copertura per rasatura 1 mt / 1 mt mask for plasterboard thinning	6,12

## DRIVER

CODE	WATT	VOLT	DESCRIPTION	MODE	SIZE	PRICE
22015	50W	24V DC	Driver MW	ON-OFF	99x82x30mm	34,45
22031	60W	24V DC	Driver EAGLERISE TRP	ON-OFF	187x45x31mm	39,69
22032	75W	24V DC	Driver EAGLERISE TRP	ON-OFF	187x45x31mm	50,72
22016	100W	24V DC	Driver MW	ON-OFF	129x97x30mm	61,74
22033	120W	24V DC	Driver EAGLERISE TRP	ON-OFF	268x45x31mm	65,05
22034	150W	24V DC	Driver EAGLERISE TRP	ON-OFF	268x45x31mm	83,79
22025	150W	24V DC	Driver MW	ON-OFF	160x95x30mm	65,05
22017	200W	24V DC	Driver MW	ON-OFF	215x115x30mm	132,30
41217	75W	24V DC	Driver dimmerabile LTECH	0-10V	144x78x38.5mm	149,14
41218	100W	24V DC	Driver dimmerabile LTECH	0-10V	240x70x36mm	164,72
41219	150W	24V DC	Driver dimmerabile LTECH	0-10V	270x79x39mm	208,13
11044	75W	24V DC	Driver LTECH	DALI	290x45x30mm	213,12
11045	150W	24V DC	Driver LTECH	DALI	290x45x30mm	292,62

## FULGOR 15W



LED BRIDGELUX  
CRI >90  
PF >0,9

CODE	FINISHING	WATT	LUMEN	WATT LIGHT SOURCE	LUMEN LIGHT SOURCE	BEAM	KELVIN	VOLT	KG	PRICE
41797	Bianco/ White	15W	1560	14,8W	1710	15°	3000K	36-38V 350mA	0,40	64,62
41811	Nero/Black	15W	1560	14,8W	1710	15°	3000K	36-38V 350mA	0,40	64,62
41804	Bianco/ White	15W	1557	14,8W	1834	15°	4000K	36-38V 350mA	0,40	64,62
41818	Nero/Black	15W	1557	14,8W	1834	15°	4000K	36-38V 350mA	0,40	64,62
41798	Bianco/ White	15W	1574	14,8W	1710	24°	3000K	36-38V 350mA	0,40	64,62
41812	Nero/Black	15W	1574	14,8W	1710	24°	3000K	36-38V 350mA	0,40	64,62
41805	Bianco/ White	15W	1584	14,8W	1834	24°	4000K	36-38V 350mA	0,40	64,62
41819	Nero/Black	15W	1584	14,8W	1834	24°	4000K	36-38V 350mA	0,40	64,62
41799	Bianco/ White	15W	1591	14,8W	1710	38°	3000K	36-38V 350mA	0,40	64,62
41813	Nero/Black	15W	1591	14,8W	1710	38°	3000K	36-38V 350mA	0,40	64,62
41806	Bianco/ White	15W	1585	14,8W	1834	38°	4000K	36-38V 350mA	0,40	64,62
41820	Nero/Black	15W	1585	14,8W	1834	38°	4000K	36-38V 350mA	0,40	64,62
41800	Bianco/ White	15W	1509	14,8W	1710	55°	3000K	36-38V 350mA	0,40	64,62
41814	Nero/Black	15W	1509	14,8W	1710	55°	3000K	36-38V 350mA	0,40	64,62
41807	Bianco/ White	15W	1531	14,8W	1834	55°	4000K	36-38V 350mA	0,40	64,62
41821	Nero/Black	15W	1531	14,8W	1834	55°	4000K	36-38V 350mA	0,40	64,62

### INSTALLAZIONE APPLICATION

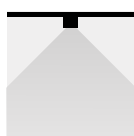

Binario/Track

### DISEGNI TECNICI TECHNICAL DRAWINGS

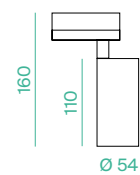

### REGOLAZIONI ADJUSTABILITY



## ACCESSORI ACCESSORIES

CODE	DESCRIPTION	PRICE
71575	Filtro honeycomb 15W/Honeycomb filter 15W	4,71

## FULGOR 15W DALI-PUSH



LED BRIDGELUX  
CRI >90  
PF >0,9

CODE	FINISHING	WATT	LUMEN	WATT LIGHT SOURCE	LUMEN LIGHT SOURCE	BEAM	KELVIN	VOLT	KG	PRICE
41825	Bianco/ White	15W	1560	14,8W	1710	15°	3000K	36-38V 350mA	0,40	136,00
41847	Nero/Black	15W	1560	14,8W	1710	15°	3000K	36-38V 350mA	0,40	136,00
41836	Bianco/ White	15W	1557	14,8W	1834	15°	4000K	36-38V 350mA	0,40	136,00
41858	Nero/Black	15W	1557	14,8W	1834	15°	4000K	36-38V 350mA	0,40	136,00
41826	Bianco/ White	15W	1574	14,8W	1710	24°	3000K	36-38V 350mA	0,40	136,00
41848	Nero/Black	15W	1574	14,8W	1710	24°	3000K	36-38V 350mA	0,40	136,00
41837	Bianco/ White	15W	1584	14,8W	1834	24°	4000K	36-38V 350mA	0,40	136,00
41859	Nero/Black	15W	1584	14,8W	1834	24°	4000K	36-38V 350mA	0,40	136,00
41827	Bianco/ White	15W	1591	14,8W	1710	38°	3000K	36-38V 350mA	0,40	136,00
41849	Nero/Black	15W	1591	14,8W	1710	38°	3000K	36-38V 350mA	0,40	136,00
41838	Bianco/ White	15W	1585	14,8W	1834	38°	4000K	36-38V 350mA	0,40	136,00
41860	Nero/Black	15W	1585	14,8W	1834	38°	4000K	36-38V 350mA	0,40	136,00
41828	Bianco/ White	15W	1509	14,8W	1710	55°	3000K	36-38V 350mA	0,40	136,00
41850	Nero/Black	15W	1509	14,8W	1710	55°	3000K	36-38V 350mA	0,40	136,00
41839	Bianco/ White	15W	1531	14,8W	1834	55°	4000K	36-38V 350mA	0,40	136,00
41861	Nero/Black	15W	1531	14,8W	1834	55°	4000K	36-38V 350mA	0,40	136,00

### INSTALLAZIONE APPLICATION

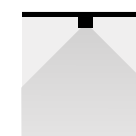

Binario/Track

### DISEGNI TECNICI TECHNICAL DRAWINGS

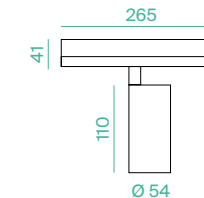

### REGOLAZIONI ADJUSTABILITY



## ACCESSORI ACCESSORIES

CODE	DESCRIPTION	PRICE
71575	Filtro honeycomb 15W/Honeycomb filter 15W	4,71

## FULGOR 24W



LED BRIDGELUX  
CRI >90  
PF >0,9

CODE	FINISHING	WATT	LUMEN	WATT LIGHT SOURCE	LUMEN LIGHT SOURCE	BEAM	KELVIN	VOLT	KG	PRICE
41678	Bianco/ White	24W	2220	24W	2640	15°	3000K	36-38V 600mA	0,60	77,28
41679	Nero/Black	24W	2220	24W	2640	15°	3000K	36-38V 600mA	0,60	77,28
41680	Bianco/ White	24W	2400	24W	2880	15°	4000K	36-38V 600mA	0,60	77,28
41681	Nero/Black	24W	2400	24W	2880	15°	4000K	36-38V 600mA	0,60	77,28
41674	Bianco/ White	24W	2280	24W	2640	24°	3000K	36-38V 600mA	0,60	77,28
41675	Nero/Black	24W	2280	24W	2640	24°	3000K	36-38V 600mA	0,60	77,28
41676	Bianco/ White	24W	2480	24W	2880	24°	4000K	36-38V 600mA	0,60	77,28
41677	Nero/Black	24W	2480	24W	2880	24°	4000K	36-38V 600mA	0,60	77,28
41670	Bianco/ White	24W	2340	24W	2640	38°	3000K	36-38V 600mA	0,60	77,28
41671	Nero/Black	24W	2340	24W	2640	38°	3000K	36-38V 600mA	0,60	77,28
41672	Bianco/ White	24W	2550	24W	2880	38°	4000K	36-38V 600mA	0,60	77,28
41673	Nero/Black	24W	2550	24W	2880	38°	4000K	36-38V 600mA	0,60	77,28
41666	Bianco/ White	24W	2310	24W	2640	55°	3000K	36-38V 600mA	0,60	77,28
41668	Nero/Black	24W	2310	24W	2640	55°	3000K	36-38V 600mA	0,60	77,28
41667	Bianco/ White	24W	2510	24W	2880	55°	4000K	36-38V 600mA	0,60	77,28
41669	Nero/Black	24W	2510	24W	2880	55°	4000K	36-38V 600mA	0,60	77,28

### INSTALLAZIONE APPLICATION

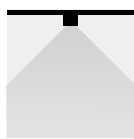

Binario/Track

### DISEGNI TECNICI TECHNICAL DRAWINGS

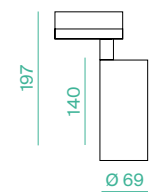

### REGOLAZIONI ADJUSTABILITY



## ACCESSORI ACCESSORIES

CODE	DESCRIPTION	PRICE
71663	Filtro honeycomb 24W/Honeycomb filter 24W	5,30

## FULGOR 24W DALI-PUSH



LED BRIDGELUX  
CRI >90  
PF >0,9

CODE	FINISHING	WATT	LUMEN	WATT LIGHT SOURCE	LUMEN LIGHT SOURCE	BEAM	KELVIN	VOLT	KG	PRICE
41829	Bianco/ White	24W	2220	24W	2640	15°	3000K	36-38V 600mA	0,60	151,00
41851	Nero/Black	24W	2220	24W	2640	15°	3000K	36-38V 600mA	0,60	151,00
41840	Bianco/ White	24W	2400	24W	2880	15°	4000K	36-38V 600mA	0,60	151,00
41862	Nero/Black	24W	2400	24W	2880	15°	4000K	36-38V 600mA	0,60	151,00
41830	Bianco/ White	24W	2280	24W	2640	24°	3000K	36-38V 600mA	0,60	151,00
41852	Nero/Black	24W	2280	24W	2640	24°	3000K	36-38V 600mA	0,60	151,00
41841	Bianco/ White	24W	2480	24W	2880	24°	4000K	36-38V 600mA	0,60	151,00
41863	Nero/Black	24W	2480	24W	2880	24°	4000K	36-38V 600mA	0,60	151,00
41831	Bianco/ White	24W	2340	24W	2640	38°	3000K	36-38V 600mA	0,60	151,00
41853	Nero/Black	24W	2340	24W	2640	38°	3000K	36-38V 600mA	0,60	151,00
41842	Bianco/ White	24W	2550	24W	2880	38°	4000K	36-38V 600mA	0,60	151,00
41864	Nero/Black	24W	2550	24W	2880	38°	4000K	36-38V 600mA	0,60	151,00
41832	Bianco/ White	24W	2310	24W	2640	55°	3000K	36-38V 600mA	0,60	151,00
41854	Nero/Black	24W	2310	24W	2640	55°	3000K	36-38V 600mA	0,60	151,00
41843	Bianco/ White	24W	2510	24W	2880	55°	4000K	36-38V 600mA	0,60	151,00
41865	Nero/Black	24W	2510	24W	2880	55°	4000K	36-38V 600mA	0,60	151,00

### INSTALLAZIONE APPLICATION

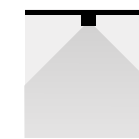

Binario/Track

### DISEGNI TECNICI TECHNICAL DRAWINGS

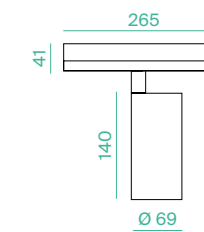

### REGOLAZIONI ADJUSTABILITY



## ACCESSORI ACCESSORIES

CODE	DESCRIPTION	PRICE
71663	Filtro honeycomb 24W/Honeycomb filter 24W	5,30

## FULGOR 35W



LED BRIDGELUX  
CRI >90  
PF >0,9

CODE	FINISHING	WATT	LUMEN	WATT LIGHT SOURCE	LUMEN LIGHT SOURCE	BEAM	KELVIN	VOLT	KG	PRICE
41801	Bianco/ White	35W	3267	33,5W	3705	15°	3000K	36-38V 850mA	0,86	95,70
41815	Nero/Black	35W	3267	33,5W	3705	15°	3000K	36-38V 850mA	0,86	95,70
41808	Bianco/ White	35W	3405	33,5W	3973	15°	4000K	36-38V 850mA	0,86	95,70
41822	Nero/Black	35W	3405	33,5W	3973	15°	4000K	36-38V 850mA	0,86	95,70
41802	Bianco/ White	35W	3408	33,5W	3705	24°	3000K	36-38V 850mA	0,86	95,70
41816	Nero/Black	35W	3408	33,5W	3705	24°	3000K	36-38V 850mA	0,86	95,70
41809	Bianco/ White	35W	3462	33,5W	3973	24°	4000K	36-38V 850mA	0,86	95,70
41823	Nero/Black	35W	3462	33,5W	3973	24°	4000K	36-38V 850mA	0,86	95,70
41803	Bianco/ White	35W	3370	33,5W	3705	38°	3000K	36-38V 850mA	0,86	95,70
41817	Nero/Black	35W	3370	33,5W	3705	38°	3000K	36-38V 850mA	0,86	95,70
41810	Bianco/ White	35W	3483	33,5W	3973	38°	4000K	36-38V 850mA	0,86	95,70
41824	Nero/Black	35W	3483	33,5W	3973	38°	4000K	36-38V 850mA	0,86	95,70
41905	Bianco/ White	35W	3410	33,5W	3705	55°	3000K	36-38V 850mA	0,86	95,70
41906	Nero/Black	35W	3410	33,5W	3705	55°	3000K	36-38V 850mA	0,86	95,70
41907	Bianco/ White	35W	3451	33,5W	3973	55°	4000K	36-38V 850mA	0,86	95,70
41908	Nero/Black	35W	3451	33,5W	3973	55°	4000K	36-38V 850mA	0,86	95,70

### INSTALLAZIONE APPLICATION

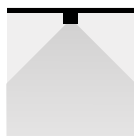

Binario/Track

### DISEGNI TECNICI TECHNICAL DRAWINGS

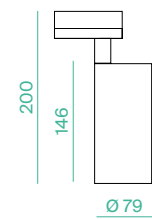

### REGOLAZIONI ADJUSTABILITY



## ACCESSORI ACCESSORIES

CODE	DESCRIPTION	PRICE
71664	Filtro honeycomb 35W/Honeycomb filter 35W	5,69

## FULGOR 35W DALI-PUSH



LED BRIDGELUX  
CRI >90  
PF >0,9

CODE	FINISHING	WATT	LUMEN	WATT LIGHT SOURCE	LUMEN LIGHT SOURCE	BEAM	KELVIN	VOLT	KG	PRICE
41833	Bianco/ White	35W	3267	33,5W	3705	15°	3000K	36-38V 850mA	0,86	174,00
41855	Nero/Black	35W	3267	33,5W	3705	15°	3000K	36-38V 850mA	0,86	174,00
41844	Bianco/ White	35W	3405	33,5W	3973	15°	4000K	36-38V 850mA	0,86	174,00
41866	Nero/Black	35W	3405	33,5W	3973	15°	4000K	36-38V 850mA	0,86	174,00
41834	Bianco/ White	35W	3408	33,5W	3705	24°	3000K	36-38V 850mA	0,86	174,00
41856	Nero/Black	35W	3408	33,5W	3705	24°	3000K	36-38V 850mA	0,86	174,00
41845	Bianco/ White	35W	3462	33,5W	3973	24°	4000K	36-38V 850mA	0,86	174,00
41867	Nero/Black	35W	3462	33,5W	3973	24°	4000K	36-38V 850mA	0,86	174,00
41835	Bianco/ White	35W	3370	33,5W	3705	38°	3000K	36-38V 850mA	0,86	174,00
41857	Nero/Black	35W	3370	33,5W	3705	38°	3000K	36-38V 850mA	0,86	174,00
41846	Bianco/ White	35W	3483	33,5W	3973	38°	4000K	36-38V 850mA	0,86	174,00
41868	Nero/Black	35W	3483	33,5W	3973	38°	4000K	36-38V 850mA	0,86	174,00
41909	Bianco/ White	35W	3410	33,5W	3705	55°	3000K	36-38V 850mA	0,86	174,00
41910	Nero/Black	35W	3410	33,5W	3705	55°	3000K	36-38V 850mA	0,86	174,00
41911	Bianco/ White	35W	3451	33,5W	3973	55°	4000K	36-38V 850mA	0,86	174,00
41912	Nero/Black	35W	3451	33,5W	3973	55°	4000K	36-38V 850mA	0,86	174,00

### INSTALLAZIONE APPLICATION



Binario/Track

### DISEGNI TECNICI TECHNICAL DRAWINGS

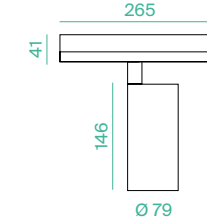

### REGOLAZIONI ADJUSTABILITY



## ACCESSORI ACCESSORIES

CODE	DESCRIPTION	PRICE
71664	Filtro honeycomb 35W/Honeycomb filter 35W	5,69



## SUN\_111 TRACK



Lampadina esclusa / Bulb not included

CODE	FINISHING	BASE	WATT	VOLTAGE	KG	PRICE
41913	Bianco/White	AR111 GU10	Max 50W	230V 50/60Hz	0,44	36,90
41914	Nero/Black	AR111 GU10	Max 50W	230V 50/60Hz	0,44	36,90

### INSTALLAZIONE APPLICATION

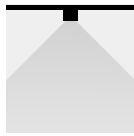

Binario/Track

### DISEGNI TECNICI TECHNICAL DRAWINGS

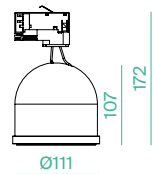

### REGOLAZIONI ADJUSTABILITY



## UNICO DICRO TRACK

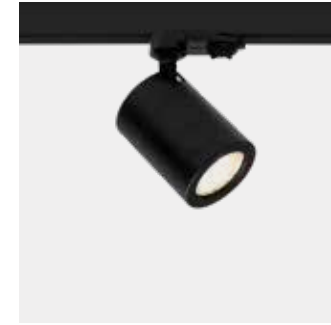

Lampadina esclusa / Bulb not included

CODE	FINISHING	BASE	VOLT	KG	PRICE
40758	Bianco/White	GU10	230V 50/60HZ	0,30	50,14
40759	Nero/Black	GU10	230V 50/60HZ	0,30	50,14

### INSTALLAZIONE APPLICATION



Binario/Track

### DISEGNI TECNICI TECHNICAL DRAWINGS

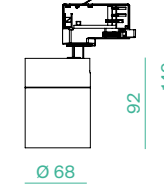

### REGOLAZIONI ADJUSTABILITY



## UNICO AR111 TRACK

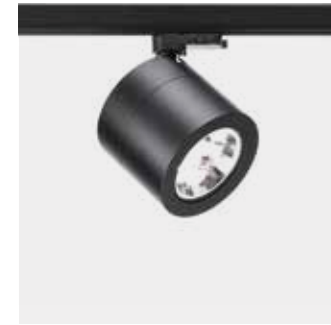

Lampadina esclusa / Bulb not included

CODE	FINISHING	BASE	VOLT	KG	PRICE
40754	Bianco/White	GU10	230V 50/60HZ	0,50	67,13
40755	Nero/Black	GU10	230V 50/60HZ	0,50	67,13

### INSTALLAZIONE APPLICATION

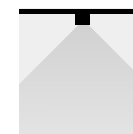

Binario/Track

### DISEGNI TECNICI TECHNICAL DRAWINGS

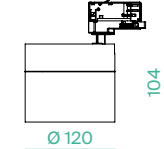

### REGOLAZIONI ADJUSTABILITY

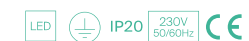

## CILINDRO TRACK



LED CREE  
CRI >90  
PF >0.5  
SDCM <3

CODE	FINISHING	WATT	LUMEN	WATT LIGHT SOURCE	LUMEN LIGHT SOURCE	BEAM	KELVIN	KG	PRICE
41927	Nero/Black	10W	749	8W	900	36°	3000K	0,40	105,00
41928	Bianco/White	10W	749	8W	900	36°	3000K	0,40	105,00

### INSTALLAZIONE APPLICATION

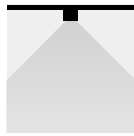

Binario/Track

### DISEGNI TECNICI TECHNICAL DRAWINGS

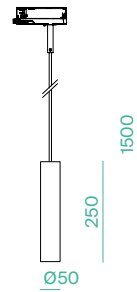

## BELL TRACK

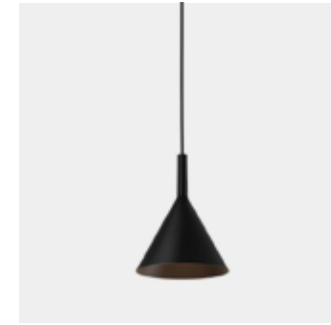

LED CREE  
CRI >90  
PF >0.5  
SDCM <3

CODE	FINISHING	WATT	LUMEN	WATT LIGHT SOURCE	LUMEN LIGHT SOURCE	BEAM	KELVIN	KG	PRICE
41925	Nero/Black	10W	415	8W	900	65°	3000K	0,40	87,15
41926	Bianco/White	10W	571	8W	900	65°	3000K	0,40	87,15

### INSTALLAZIONE APPLICATION



Binario/Track

### DISEGNI TECNICI TECHNICAL DRAWINGS

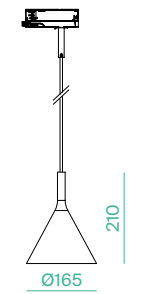

## GLOBO TRACK



LED CREE  
CRI >90  
PF >0.5  
SDCM <3

CODE	FINISHING	WATT	LUMEN	WATT LIGHT SOURCE	LUMEN LIGHT SOURCE	BEAM	KELVIN	KG	PRICE
41923	Nero/Black	10W	680	8W	1105	Diff.	3000K	0,45	90,30
41924	Bianco/White	10W	680	8W	1105	Diff.	3000K	0,45	90,30

### INSTALLAZIONE APPLICATION

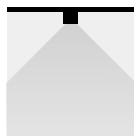

Binario/Track

### DISEGNI TECNICI TECHNICAL DRAWINGS

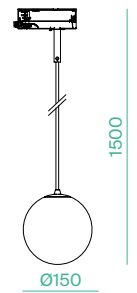

# STREAMLIGHT



LED SAMSUNG  
CRI >82  
PF 0,9

CODE	MODEL	FINISHING	WATT	LUMEN	WATT LIGHT SOURCE	LUMEN LIGHT SOURCE	BEAM	KELVIN	KG	PRICE
41094	Asymmetric A	Bianco/White	55W	5300	47W	6625	25°	3000K	1,00	194,66
41095	Asymmetric A	Bianco/White	55W	5700	47W	7125	25°	4000K	1,00	194,66
41098	Asymmetric A	Nero/Black	55W	5300	47W	6625	25°	3000K	1,00	194,66
41099	Asymmetric A	Nero/Black	55W	5700	47W	7125	25°	4000K	1,00	194,66
41096	Asymmetric B	Bianco/White	55W	5300	47W	6625	25°	3000K	1,00	194,66
41097	Asymmetric B	Bianco/White	55W	5700	47W	7125	25°	4000K	1,00	194,66
41100	Asymmetric B	Nero/Black	55W	5300	47W	6625	25°	3000K	1,00	194,66
41101	Asymmetric B	Nero/Black	55W	5700	47W	7125	25°	4000K	1,00	194,66
41102	Symmetric	Bianco/White	55W	5300	47W	6625	85°*85°	3000K	1,00	194,66
41103	Symmetric	Bianco/White	55W	5700	47W	7125	85°*85°	4000K	1,00	194,66
41104	Symmetric	Nero/Black	55W	5300	47W	6625	85°*85°	3000K	1,00	194,66
41105	Symmetric	Nero/Black	55W	5700	47W	7125	85°*85°	4000K	1,00	194,66

## INSTALLAZIONE APPLICATION

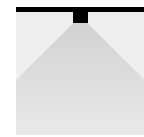

Binario/Track

## ASYMMETRIC A ASYMMETRIC B

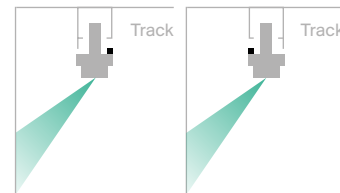

## DISEGNI TECNICI TECHNICAL DRAWINGS

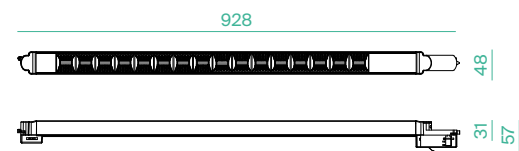

# TRACKS

CODE	FINISHING	DESCRIPTION	KG	PRICE
60037	Nero/Black	Euro-track binario/track 1 mt.	0,90	34,58
60040	Nero/Black	Euro-track binario/track 2 mt.	1,80	63,72
60043	Nero/Black	Euro-track binario/track 3 mt.	2,70	93,05
60038	Bianco/White	Euro-track binario/track 1 mt.	0,90	34,58
60041	Bianco/White	Euro-track binario/track 2 mt.	1,80	63,72
60044	Bianco/White	Euro-track binario/track 3 mt.	2,70	93,05

## INSTALLAZIONE APPLICATION



Soffitto/Ceiling

## DISEGNI TECNICI TECHNICAL DRAWINGS

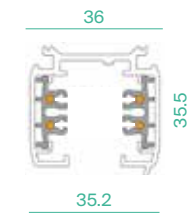

# TRACKS INCASSO

CODE	FINISHING	DESCRIPTION	KG	PRICE
60100	Nero/Black	Euro-track binario incasso/ Recessed track 2 mt.	2,00	74,96
60102	Nero/Black	Euro-track binario incasso/ Recessed track 3 mt.	3,00	109,47
60101	Bianco/White	Euro-track binario incasso/ Recessed track 2 mt.	2,00	74,96
60103	Bianco/White	Euro-track binario incasso/ Recessed track 3 mt.	3,00	109,47

## INSTALLAZIONE APPLICATION

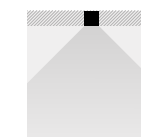

Incasso/Recessed

## DISEGNI TECNICI TECHNICAL DRAWINGS

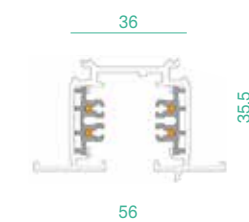

ACCESSORI  
ACCESSORIES

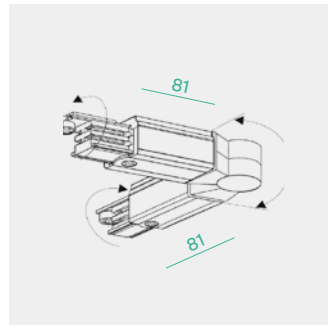

60046 - 60047

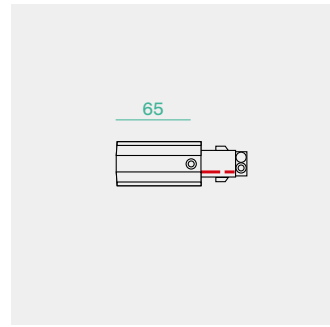

60049 - 60050

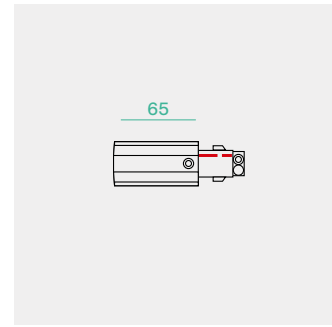

60052 - 60053

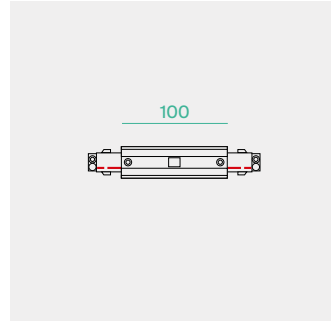

60084 - 60085

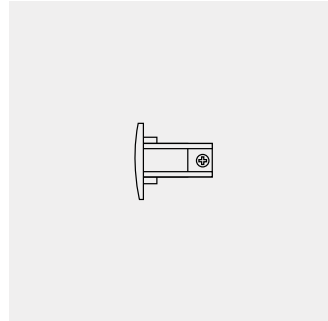

60055 - 60056



60088 - 60089

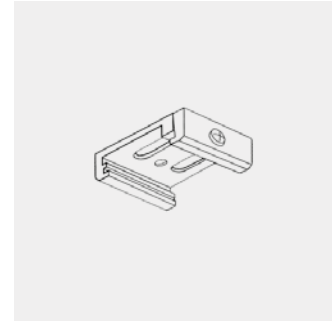

60086 - 60087

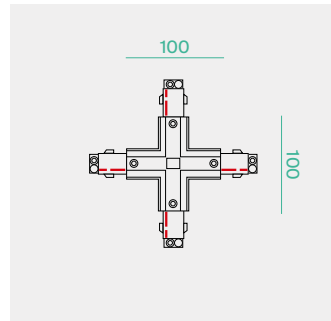

60079 - 60080

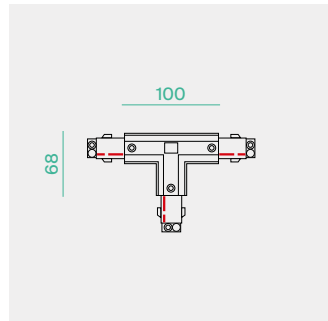

60067 - 60068

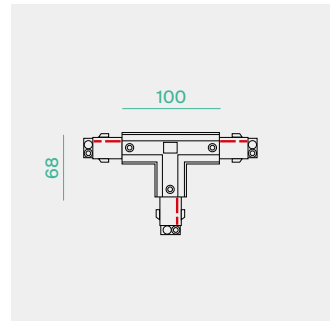

60070 - 60071

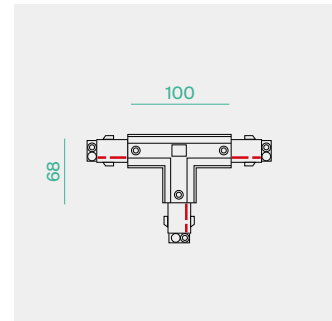

60073 - 60074

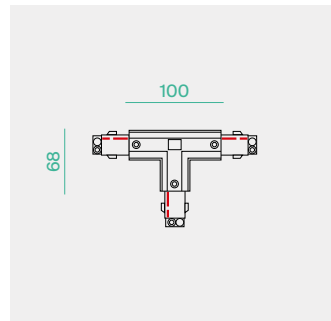

60076 - 60077

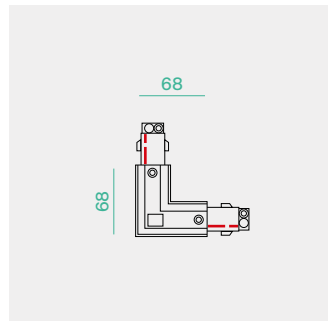

60061 - 60062

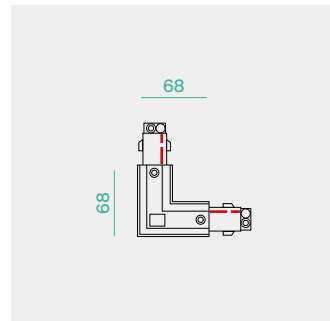

60064 - 60065

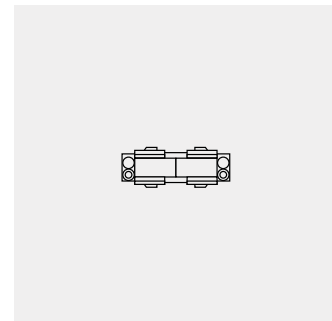

60058 - 60059

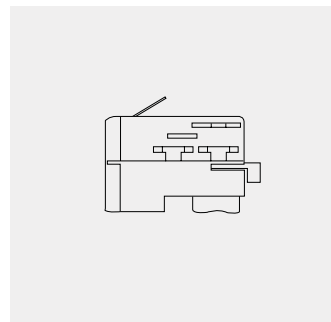

52582/N - 52582/B



11620 - 11621

ACCESSORI  
ACCESSORIES

CODE	FINISHING	DESCRIPTION	PRICE
60046	Nero/Black	Curva regolabile/Adjustable junction	23,76
60047	Bianco/White	Curva regolabile/Adjustable junction	23,76
60049	Nero/Black	Alimentazione sinistra/Left feed	12,01
60050	Bianco/White	Alimentazione sinistra/Left feed	12,01
60052	Nero/Black	Alimentazione destra/Right feed	12,01
60053	Bianco/White	Alimentazione destra/Right feed	12,01
60084	Nero/Black	Alimentazione centrale/Middle feed	21,76
60085	Bianco/White	Alimentazione centrale/Middle feed	21,76
60055	Nero/Black	Testata di chiusura/End-cap	1,53
60056	Bianco/White	Testata di chiusura/End-cap	1,53
60088	Nero/Black	Kit sospensione con cavo 2 mt./Suspension kit with cable 2 mt.	13,48
60089	Bianco/White	Kit sospensione con cavo 2 mt./Suspension kit with cable 2 mt.	13,48
60086	Nero/Black	Staffa soffitto/Ceiling bracket	4,19
60087	Bianco/White	Staffa soffitto/Ceiling bracket	4,19
60079	Nero/Black	Giunto "+" connector	36,84
60080	Bianco/White	Giunto "+" connector	36,84
60067	Nero/Black	Giunto-1 "T"/"T"connector-1	30,98
60068	Bianco/White	Giunto-1 "T"/"T"connector-1	30,98
60070	Nero/Black	Giunto-2 "T"/"T"connector-2	30,98
60071	Bianco/White	Giunto-2 "T"/"T"connector-2	30,98
60073	Nero/Black	Giunto-3 "T"/"T"connector-3	30,98
60074	Bianco/White	Giunto-3 "T"/"T"connector-3	30,98
60076	Nero/Black	Giunto-4 "T"/"T"connector-4	30,98
60077	Bianco/White	Giunto-4 "T"/"T"connector-4	30,98
60061	Nero/Black	Giunto-1 "L"/"L"connector-1	21,76
60062	Bianco/White	Giunto-1 "L"/"L"connector-1	21,76
60064	Nero/Black	Giunto-2 "L"/"L"connector-2	21,76
60065	Bianco/White	Giunto-2 "L"/"L"connector-2	21,76
60058	Nero/Black	Congiunzione/ straight connector	6,67
60059	Bianco/White	Congiunzione/ straight connector	6,67
52582/N	Nero/Black	Adattatore binario/track adaptor	10,38
52582/B	Bianco/White	Adattatore binario/track adaptor	10,38
11621	Nero/Black	Accessorio soffitto per Euro-track / Euro-track ceiling accessory	20,28
11620	Bianco/White	Accessorio soffitto per Euro-track / Euro-track ceiling accessory	20,28

ACCESSORI  
ACCESSORIES

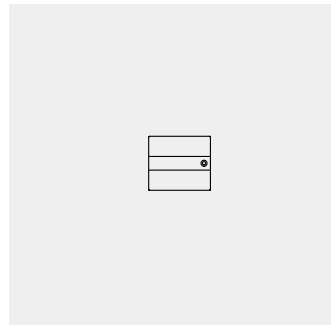

60104 - 60105

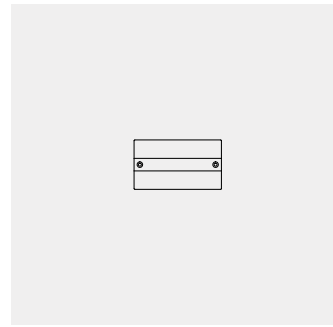

60106 - 60107

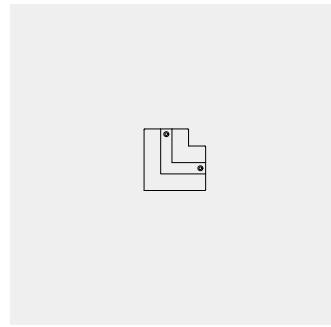

60108 - 60109

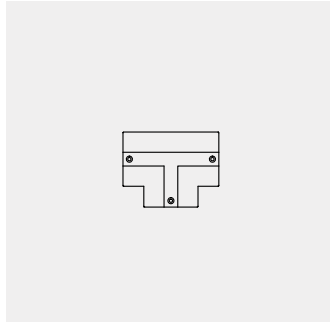

60110 - 60111

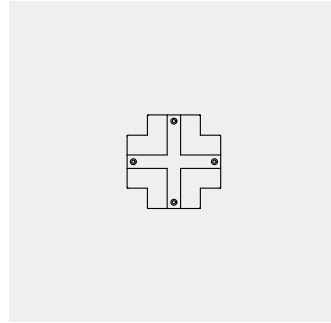

60112 - 60113

CODE	FINISHING	DESCRIPTION	PRICE
60104	Nero/Black	Copertura alim. sx/dx binario incasso/ Right/left feed cover	2,07
60105	Bianco/White	Copertura alim. sx/dx binario incasso/ Right/left feed cover	2,07
60106	Nero/Black	Copertura alim. centrale binario incasso/ Middle feed cover	2,66
60107	Bianco/White	Copertura alim. centrale binario incasso/ Middle feed cover	2,66
60108	Nero/Black	Copertura giunto "L" binario incasso/ "L" connector cover	2,66
60109	Bianco/White	Copertura giunto "L" binario incasso/ "L" connector cover	2,66
60110	Nero/Black	Copertura giunto "T" binario incasso/ "T" connector cover	2,66
60111	Bianco/White	Copertura giunto "T" binario incasso/ "T" connector cover	2,66
60112	Nero/Black	Copertura giunto "+" binario incasso/ "+" connector cover	3,26
60113	Bianco/White	Copertura giunto "+" binario incasso/ "+" connector cover	3,26

EMERGENZA

Lampada emergenza 3W  
per binari Autonomia 3 H  
Emergency track lamp 3W  
3 Hours autonomy



CODE	FINISHING	WATT	LUMEN	KELVIN	PRICE
60091	Nero/Black	3	110	3000K	156,89
60092	Bianco/White	3	110	3000K	156,89

INSTALLAZIONE  
APPLICATION

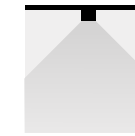

Binario/Track

DISEGNI TECNICI  
TECHNICAL DRAWINGS

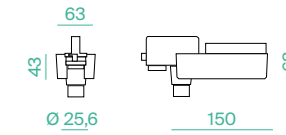

# DEEP\_EVO EXTR. 9W



LED V6HD  
CRI 90  
PF 0,56  
SDCM <3  
UGR <20

CODE	FINISHING	WATT	LUMEN	WATT LIGHT SOURCE	LUMEN LIGHT SOURCE	BEAM	KELVIN	DRIVER	MODE	KG	PRICE
71794	Bianco/White	9	645	7	835	15°	3000K	30-42V 200mA	ON-OFF	0,20	37,20
71795	Bianco/White	9	680	7	835	24°	3000K	30-42V 200mA	ON-OFF	0,20	37,20
71796	Bianco/White	9	685	7	835	38°	3000K	30-42V 200mA	ON-OFF	0,20	37,20
71797	Bianco/White	9	675	7	835	55°	3000K	30-42V 200mA	ON-OFF	0,20	37,20
71798	Nero/Black	9	645	7	835	15°	3000K	30-42V 200mA	ON-OFF	0,20	37,20
71799	Nero/Black	9	680	7	835	24°	3000K	30-42V 200mA	ON-OFF	0,20	37,20
71800	Nero/Black	9	685	7	835	38°	3000K	30-42V 200mA	ON-OFF	0,20	37,20
71801	Nero/Black	9	675	7	835	55°	3000K	30-42V 200mA	ON-OFF	0,20	37,20
71842	Bianco/White	9	645	7	835	15°	3000K	30-42V 200mA	1-10V	0,20	53,80
71843	Bianco/White	9	680	7	835	24°	3000K	30-42V 200mA	1-10V	0,20	53,80
71844	Bianco/White	9	685	7	835	38°	3000K	30-42V 200mA	1-10V	0,20	53,80
71845	Bianco/White	9	675	7	835	55°	3000K	30-42V 200mA	1-10V	0,20	53,80
71846	Nero/Black	9	645	7	835	15°	3000K	30-42V 200mA	1-10V	0,20	53,80
71847	Nero/Black	9	680	7	835	24°	3000K	30-42V 200mA	1-10V	0,20	53,80
71848	Nero/Black	9	685	7	835	38°	3000K	30-42V 200mA	1-10V	0,20	53,80
71849	Nero/Black	9	675	7	835	55°	3000K	30-42V 200mA	1-10V	0,20	53,80
71890	Bianco/White	9	675	7	835	15°	3000K	30-42V 200mA	DALI-PUSH	0,20	77,55
71891	Bianco/White	9	675	7	835	24°	3000K	30-42V 200mA	DALI-PUSH	0,20	77,55
71892	Bianco/White	9	675	7	835	38°	3000K	30-42V 200mA	DALI-PUSH	0,20	77,55
71893	Bianco/White	9	675	7	835	55°	3000K	30-42V 200mA	DALI-PUSH	0,20	77,55
71894	Nero/Black	9	675	7	835	15°	3000K	30-42V 200mA	DALI-PUSH	0,20	77,55
71895	Nero/Black	9	675	7	835	24°	3000K	30-42V 200mA	DALI-PUSH	0,20	77,55
71896	Nero/Black	9	675	7	835	38°	3000K	30-42V 200mA	DALI-PUSH	0,20	77,55
71897	Nero/Black	9	675	7	835	55°	3000K	30-42V 200mA	DALI-PUSH	0,20	77,55

## INSTALLAZIONE APPLICATION

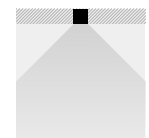

Incasso/Recessed

## DISEGNI TECNICI TECHNICAL DRAWINGS

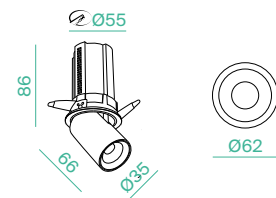

## REGOLAZIONI ADJUSTABILITY



# DEEP\_EVO\_LESS EXTR. 9W



LED V6HD  
CRI 90  
PF 0,56  
SDCM <3  
UGR <23

CODE	FINISHING	WATT	LUMEN	WATT LIGHT SOURCE	LUMEN LIGHT SOURCE	BEAM	KELVIN	DRIVER	MODE	KG	PRICE
71818	Bianco/White	9	645	7	835	15°	3000K	30-42V 200mA	ON-OFF	0,20	42,14
71819	Bianco/White	9	680	7	835	24°	3000K	30-42V 200mA	ON-OFF	0,20	42,14
71820	Bianco/White	9	685	7	835	38°	3000K	30-42V 200mA	ON-OFF	0,20	42,14
71821	Bianco/White	9	675	7	835	55°	3000K	30-42V 200mA	ON-OFF	0,20	42,14
71822	Nero/Black	9	645	7	835	15°	3000K	30-42V 200mA	ON-OFF	0,20	42,14
71823	Nero/Black	9	680	7	835	24°	3000K	30-42V 200mA	ON-OFF	0,20	42,14
71824	Nero/Black	9	685	7	835	38°	3000K	30-42V 200mA	ON-OFF	0,20	42,14
71825	Nero/Black	9	675	7	835	55°	3000K	30-42V 200mA	ON-OFF	0,20	42,14
71866	Bianco/White	9	645	7	835	15°	3000K	30-42V 200mA	1-10V	0,20	58,74
71867	Bianco/White	9	680	7	835	24°	3000K	30-42V 200mA	1-10V	0,20	58,74
71868	Bianco/White	9	685	7	835	38°	3000K	30-42V 200mA	1-10V	0,20	58,74
71869	Bianco/White	9	675	7	835	55°	3000K	30-42V 200mA	1-10V	0,20	58,74
71870	Nero/Black	9	645	7	835	15°	3000K	30-42V 200mA	1-10V	0,20	58,74
71871	Nero/Black	9	680	7	835	24°	3000K	30-42V 200mA	1-10V	0,20	58,74
71872	Nero/Black	9	685	7	835	38°	3000K	30-42V 200mA	1-10V	0,20	58,74
71873	Nero/Black	9	675	7	835	55°	3000K	30-42V 200mA	1-10V	0,20	58,74
71914	Bianco/White	9	675	7	835	15°	3000K	30-42V 200mA	DALI-PUSH	0,20	82,49
71915	Bianco/White	9	675	7	835	24°	3000K	30-42V 200mA	DALI-PUSH	0,20	82,49
71916	Bianco/White	9	675	7	835	38°	3000K	30-42V 200mA	DALI-PUSH	0,20	82,49
71917	Bianco/White	9	675	7	835	55°	3000K	30-42V 200mA	DALI-PUSH	0,20	82,49
71918	Nero/Black	9	675	7	835	15°	3000K	30-42V 200mA	DALI-PUSH	0,20	82,49
71919	Nero/Black	9	675	7	835	24°	3000K	30-42V 200mA	DALI-PUSH	0,20	82,49
71920	Nero/Black	9	675	7	835	38°	3000K	30-42V 200mA	DALI-PUSH	0,20	82,49
71921	Nero/Black	9	675	7	835	55°	3000K	30-42V 200mA	DALI-PUSH	0,20	82,49

## INSTALLAZIONE APPLICATION

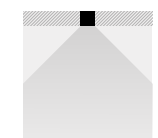

Incasso/Recessed

## DISEGNI TECNICI TECHNICAL DRAWINGS

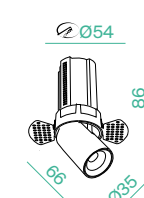

## REGOLAZIONI ADJUSTABILITY



## DEEP\_EVO EXTR. 12W



LED V6HD  
CRI 90  
PF 0,94  
SDCM <3  
UGR <20

CODE	FINISHING	WATT	LUMEN	WATT LIGHT SOURCE	LUMEN LIGHT SOURCE	BEAM	KELVIN	DRIVER	MODE	KG	PRICE
71802	Bianco/White	12	940	10,8	1151	15°	3000K	30-42V 300mA	ON-OFF	0,32	47,90
71803	Bianco/White	12	1040	10,8	1151	24°	3000K	30-42V 300mA	ON-OFF	0,32	47,90
71804	Bianco/White	12	1000	10,8	1151	38°	3000K	30-42V 300mA	ON-OFF	0,32	47,90
71805	Bianco/White	12	990	10,8	1151	55°	3000K	30-42V 300mA	ON-OFF	0,32	47,90
71806	Nero/Black	12	940	10,8	1151	15°	3000K	30-42V 300mA	ON-OFF	0,32	47,90
71807	Nero/Black	12	1040	10,8	1151	24°	3000K	30-42V 300mA	ON-OFF	0,32	47,90
71808	Nero/Black	12	1000	10,8	1151	38°	3000K	30-42V 300mA	ON-OFF	0,32	47,90
71809	Nero/Black	12	990	10,8	1151	55°	3000K	30-42V 300mA	ON-OFF	0,32	47,90
71850	Bianco/White	12	940	10,8	1151	15°	3000K	30-42V 300mA	1-10V	0,32	69,15
71851	Bianco/White	12	1040	10,8	1151	24°	3000K	30-42V 300mA	1-10V	0,32	69,15
71852	Bianco/White	12	1000	10,8	1151	38°	3000K	30-42V 300mA	1-10V	0,32	69,15
71853	Bianco/White	12	990	10,8	1151	55°	3000K	30-42V 300mA	1-10V	0,32	69,15
71854	Nero/Black	12	940	10,8	1151	15°	3000K	30-42V 300mA	1-10V	0,32	69,15
71855	Nero/Black	12	1040	10,8	1151	24°	3000K	30-42V 300mA	1-10V	0,32	69,15
71856	Nero/Black	12	1000	10,8	1151	38°	3000K	30-42V 300mA	1-10V	0,32	69,15
71857	Nero/Black	12	990	10,8	1151	55°	3000K	30-42V 300mA	1-10V	0,32	69,15
71898	Bianco/White	12	940	10,8	1151	15°	3000K	30-42V 300mA	DALI-PUSH	0,32	87,15
71899	Bianco/White	12	1040	10,8	1151	24°	3000K	30-42V 300mA	DALI-PUSH	0,32	87,15
71900	Bianco/White	12	1000	10,8	1151	38°	3000K	30-42V 300mA	DALI-PUSH	0,32	87,15
71901	Bianco/White	12	990	10,8	1151	55°	3000K	30-42V 300mA	DALI-PUSH	0,32	87,15
71902	Nero/Black	12	940	10,8	1151	15°	3000K	30-42V 300mA	DALI-PUSH	0,32	87,15
71903	Nero/Black	12	1040	10,8	1151	24°	3000K	30-42V 300mA	DALI-PUSH	0,32	87,15
71904	Nero/Black	12	1000	10,8	1151	38°	3000K	30-42V 300mA	DALI-PUSH	0,32	87,15
71905	Nero/Black	12	990	10,8	1151	55°	3000K	30-42V 300mA	DALI-PUSH	0,32	87,15

### INSTALLAZIONE APPLICATION

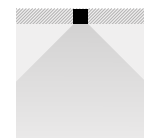

Incasso/Recessed

### DISEGNI TECNICI TECHNICAL DRAWINGS

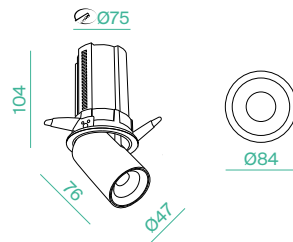

### REGOLAZIONI ADJUSTABILITY



## DEEP\_EVO\_LESS EXTR. 12W



LED V6HD  
CRI 90  
PF 0,94  
SDCM <3  
UGR <20

CODE	FINISHING	WATT	LUMEN	WATT LIGHT SOURCE	LUMEN LIGHT SOURCE	BEAM	KELVIN	DRIVER	MODE	KG	PRICE
71826	Bianco/White	12	940	10,8	1151	15°	3000K	30-42V 300mA	ON-OFF	0,32	53,57
71827	Bianco/White	12	1040	10,8	1151	24°	3000K	30-42V 300mA	ON-OFF	0,32	53,57
71828	Bianco/White	12	1000	10,8	1151	38°	3000K	30-42V 300mA	ON-OFF	0,32	53,57
71829	Bianco/White	12	990	10,8	1151	55°	3000K	30-42V 300mA	ON-OFF	0,32	53,57
71830	Nero/Black	12	940	10,8	1151	15°	3000K	30-42V 300mA	ON-OFF	0,32	53,57
71831	Nero/Black	12	1040	10,8	1151	24°	3000K	30-42V 300mA	ON-OFF	0,32	53,57
71832	Nero/Black	12	1000	10,8	1151	38°	3000K	30-42V 300mA	ON-OFF	0,32	53,57
71833	Nero/Black	12	990	10,8	1151	55°	3000K	30-42V 300mA	ON-OFF	0,32	53,57
71874	Bianco/White	12	940	10,8	1151	15°	3000K	30-42V 300mA	1-10V	0,32	74,82
71875	Bianco/White	12	1040	10,8	1151	24°	3000K	30-42V 300mA	1-10V	0,32	74,82
71876	Bianco/White	12	1000	10,8	1151	38°	3000K	30-42V 300mA	1-10V	0,32	74,82
71877	Bianco/White	12	990	10,8	1151	55°	3000K	30-42V 300mA	1-10V	0,32	74,82
71878	Nero/Black	12	940	10,8	1151	15°	3000K	30-42V 300mA	1-10V	0,32	74,82
71879	Nero/Black	12	1040	10,8	1151	24°	3000K	30-42V 300mA	1-10V	0,32	74,82
71880	Nero/Black	12	1000	10,8	1151	38°	3000K	30-42V 300mA	1-10V	0,32	74,82
71881	Nero/Black	12	990	10,8	1151	55°	3000K	30-42V 300mA	1-10V	0,32	74,82
71922	Bianco/White	12	940	10,8	1151	15°	3000K	30-42V 300mA	DALI-PUSH	0,32	92,82
71923	Bianco/White	12	1040	10,8	1151	24°	3000K	30-42V 300mA	DALI-PUSH	0,32	92,82
71924	Bianco/White	12	1000	10,8	1151	38°	3000K	30-42V 300mA	DALI-PUSH	0,32	92,82
71925	Bianco/White	12	990	10,8	1151	55°	3000K	30-42V 300mA	DALI-PUSH	0,32	92,82
71926	Nero/Black	12	940	10,8	1151	15°	3000K	30-42V 300mA	DALI-PUSH	0,32	92,82
71927	Nero/Black	12	1040	10,8	1151	24°	3000K	30-42V 300mA	DALI-PUSH	0,32	92,82
71928	Nero/Black	12	1000	10,8	1151	38°	3000K	30-42V 300mA	DALI-PUSH	0,32	92,82
71929	Nero/Black	12	990	10,8	1151	55°	3000K	30-42V 300mA	DALI-PUSH	0,32	92,82

### INSTALLAZIONE APPLICATION

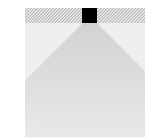

Incasso/Recessed

### DISEGNI TECNICI TECHNICAL DRAWINGS

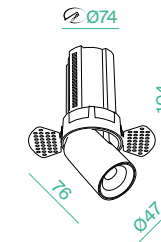

### REGOLAZIONI ADJUSTABILITY



# DEEP\_EVO EXTR. 15W



LED V6HD  
CRI 90  
PF 0,95  
SDCM <3  
UGR <20

CODE	FINISHING	WATT	LUMEN	WATT LIGHT SOURCE	LUMEN LIGHT SOURCE	BEAM	KELVIN	DRIVER	MODE	KG	PRICE
71810	Bianco/White	15	1040	12,8	1286	15°	3000K	30-42V 350mA	ON-OFF	0,62	61,75
71811	Bianco/White	15	1145	12,8	1286	24°	3000K	30-42V 350mA	ON-OFF	0,62	61,75
71812	Bianco/White	15	1099	12,8	1286	38°	3000K	30-42V 350mA	ON-OFF	0,62	61,75
71813	Bianco/White	15	1005	12,8	1286	55°	3000K	30-42V 350mA	ON-OFF	0,62	61,75
71814	Nero/Black	15	1040	12,8	1286	15°	3000K	30-42V 350mA	ON-OFF	0,62	61,75
71815	Nero/Black	15	1145	12,8	1286	24°	3000K	30-42V 350mA	ON-OFF	0,62	61,75
71816	Nero/Black	15	1099	12,8	1286	38°	3000K	30-42V 350mA	ON-OFF	0,62	61,75
71817	Nero/Black	15	1005	12,8	1286	55°	3000K	30-42V 350mA	ON-OFF	0,62	61,75
71858	Bianco/White	15	1040	12,8	1286	15°	3000K	30-42V 350mA	1-10V	0,62	86,25
71859	Bianco/White	15	1145	12,8	1286	24°	3000K	30-42V 350mA	1-10V	0,62	86,25
71860	Bianco/White	15	1099	12,8	1286	38°	3000K	30-42V 350mA	1-10V	0,62	86,25
71861	Bianco/White	15	1005	12,8	1286	55°	3000K	30-42V 350mA	1-10V	0,62	86,25
71862	Nero/Black	15	1040	12,8	1286	15°	3000K	30-42V 350mA	1-10V	0,62	86,25
71863	Nero/Black	15	1145	12,8	1286	24°	3000K	30-42V 350mA	1-10V	0,62	86,25
71864	Nero/Black	15	1099	12,8	1286	38°	3000K	30-42V 350mA	1-10V	0,62	86,25
71865	Nero/Black	15	1005	12,8	1286	55°	3000K	30-42V 350mA	1-10V	0,62	86,25
71906	Bianco/White	15	1040	12,8	1286	15°	3000K	30-42V 350mA	DALI-PUSH	0,62	103,75
71907	Bianco/White	15	1145	12,8	1286	24°	3000K	30-42V 350mA	DALI-PUSH	0,62	103,75
71908	Bianco/White	15	1099	12,8	1286	38°	3000K	30-42V 350mA	DALI-PUSH	0,62	103,75
71909	Bianco/White	15	1005	12,8	1286	55°	3000K	30-42V 350mA	DALI-PUSH	0,62	103,75
71910	Nero/Black	15	1040	12,8	1286	15°	3000K	30-42V 350mA	DALI-PUSH	0,62	103,75
71911	Nero/Black	15	1145	12,8	1286	24°	3000K	30-42V 350mA	DALI-PUSH	0,62	103,75
71912	Nero/Black	15	1099	12,8	1286	38°	3000K	30-42V 350mA	DALI-PUSH	0,62	103,75
71913	Nero/Black	15	1005	12,8	1286	55°	3000K	30-42V 350mA	DALI-PUSH	0,62	103,75

## INSTALLAZIONE APPLICATION

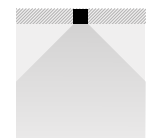

Incasso/Recessed

## DISEGNI TECNICI TECHNICAL DRAWINGS

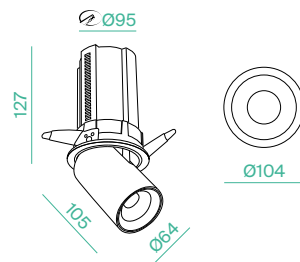

## REGOLAZIONI ADJUSTABILITY



# DEEP\_EVO\_LESS EXTR. 15W



LED V6HD  
CRI 90  
PF 0,96  
SDCM <3  
UGR <20

CODE	FINISHING	WATT	LUMEN	WATT LIGHT SOURCE	LUMEN LIGHT SOURCE	BEAM	KELVIN	DRIVER	MODE	KG	PRICE
71834	Bianco/White	15	1040	12,8	1286	15°	3000K	30-42V 350mA	ON-OFF	0,62	68,20
71835	Bianco/White	15	1145	12,8	1286	24°	3000K	30-42V 350mA	ON-OFF	0,62	68,20
71836	Bianco/White	15	1099	12,8	1286	38°	3000K	30-42V 350mA	ON-OFF	0,62	68,20
71837	Bianco/White	15	1005	12,8	1286	55°	3000K	30-42V 350mA	ON-OFF	0,62	68,20
71838	Nero/Black	15	1040	12,8	1286	15°	3000K	30-42V 350mA	ON-OFF	0,62	68,20
71839	Nero/Black	15	1145	12,8	1286	24°	3000K	30-42V 350mA	ON-OFF	0,62	68,20
71840	Nero/Black	15	1099	12,8	1286	38°	3000K	30-42V 350mA	ON-OFF	0,62	68,20
71841	Nero/Black	15	1005	12,8	1286	55°	3000K	30-42V 350mA	ON-OFF	0,62	68,20
71882	Bianco/White	15	1040	12,8	1286	15°	3000K	30-42V 350mA	1-10V	0,62	92,47
71883	Bianco/White	15	1145	12,8	1286	24°	3000K	30-42V 350mA	1-10V	0,62	92,47
71884	Bianco/White	15	1099	12,8	1286	38°	3000K	30-42V 350mA	1-10V	0,62	92,47
71885	Bianco/White	15	1005	12,8	1286	55°	3000K	30-42V 350mA	1-10V	0,62	92,47
71886	Nero/Black	15	1040	12,8	1286	15°	3000K	30-42V 350mA	1-10V	0,62	92,47
71887	Nero/Black	15	1145	12,8	1286	24°	3000K	30-42V 350mA	1-10V	0,62	92,47
71888	Nero/Black	15	1099	12,8	1286	38°	3000K	30-42V 350mA	1-10V	0,62	92,47
71889	Nero/Black	15	1005	12,8	1286	55°	3000K	30-42V 350mA	1-10V	0,62	92,47
71930	Bianco/White	15	1040	12,8	1286	15°	3000K	30-42V 350mA	DALI-PUSH	0,62	109,97
71931	Bianco/White	15	1145	12,8	1286	24°	3000K	30-42V 350mA	DALI-PUSH	0,62	109,97
71932	Bianco/White	15	1099	12,8	1286	38°	3000K	30-42V 350mA	DALI-PUSH	0,62	109,97
71933	Bianco/White	15	1005	12,8	1286	55°	3000K	30-42V 350mA	DALI-PUSH	0,62	109,97
71934	Nero/Black	15	1040	12,8	1286	15°	3000K	30-42V 350mA	DALI-PUSH	0,62	109,97
71935	Nero/Black	15	1145	12,8	1286	24°	3000K	30-42V 350mA	DALI-PUSH	0,62	109,97
71936	Nero/Black	15	1099	12,8	1286	38°	3000K	30-42V 350mA	DALI-PUSH	0,62	109,97
71937	Nero/Black	15	1005	12,8	1286	55°	3000K	30-42V 350mA	DALI-PUSH	0,62	109,97

## INSTALLAZIONE APPLICATION

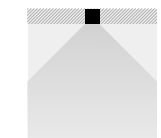

Incasso/Recessed

## DISEGNI TECNICI TECHNICAL DRAWINGS

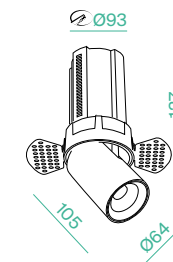

## REGOLAZIONI ADJUSTABILITY





## DEEP\_EVO FIX



CODE	BODY FINISHING	FINISHING REFLECTOR	MODULI	KG	PRICE
71582	Bianco/White	Bianco/White	Pag. 66-67	0,12	15,90
71583	Bianco/White	Nero/Black	Pag. 66-67	0,12	15,90
71585	Nero/Black	Bianco/White	Pag. 66-67	0,12	15,90
71586	Nero/Black	Nero/Black	Pag. 66-67	0,12	15,90

## DEEP\_EVO LESS FIX



CODE	BODY FINISHING	FINISHING REFLECTOR	MODULI	KG	PRICE
71594	Bianco/White	Bianco/White	Pag. 66-67	0,13	23,43
71595	Bianco/White	Nero/Black	Pag. 66-67	0,13	23,43

## DEEP\_EVO ADJUSTABLE



CODE	BODY FINISHING	FINISHING REFLECTOR	MODULI	KG	PRICE
71588	Bianco/White	Bianco/White	Pag. 66-67	0,12	15,90
71589	Bianco/White	Nero/Black	Pag. 66-67	0,12	15,90
71591	Nero/Black	Bianco/White	Pag. 66-67	0,12	15,90
71592	Nero/Black	Nero/Black	Pag. 66-67	0,12	15,90

REGOLAZIONI  
ADJUSTABILITY



## DEEP\_EVO LESS ADJUSTABLE



CODE	BODY FINISHING	FINISHING REFLECTOR	MODULI	KG	PRICE
71597	Bianco/White	Bianco/White	Pag. 66-67	0,13	23,43
71598	Bianco/White	Nero/Black	Pag. 66-67	0,13	23,43

REGOLAZIONI  
ADJUSTABILITY



INSTALLAZIONE  
APPLICATION

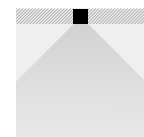

Incasso/Recessed

DISEGNI TECNICI C/ MODULO LED  
TECHNICAL DRAWING W/ LED MODULE

LED Module 9W

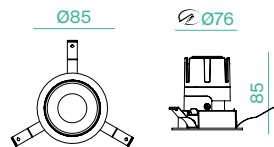

LED Module 12W-15W

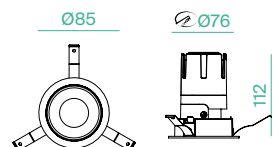

INSTALLAZIONE  
APPLICATION



Incasso/Recessed

DISEGNI TECNICI C/ MODULO LED  
TECHNICAL DRAWING W/ LED MODULE

LED Module 9W

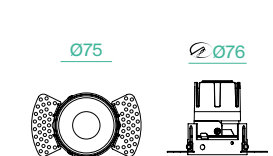

LED Module 12W-15W

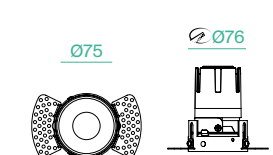

## DEEP\_EVO\_GU10 FIX



CODE	BODY FINISHING	FINISHING REFLECTOR	BASE	KG	PRICE
71645	Bianco/White	Bianco/White	GU10	0,12	19,90
71646	Bianco/White	Nero/Black	GU10	0,12	19,90
71651	Nero/Black	Bianco/White	GU10	0,12	19,90
71652	Nero/Black	Nero/Black	GU10	0,12	19,90

## DEEP\_EVO\_GU10 ADJUSTABLE



CODE	BODY FINISHING	FINISHING REFLECTOR	BASE	KG	PRICE
71648	Bianco/White	Bianco/White	GU10	0,12	19,90
71649	Bianco/White	Nero/Black	GU10	0,12	19,90
71654	Nero/Black	Bianco/White	GU10	0,12	19,90
71655	Nero/Black	Nero/Black	GU10	0,12	19,90

REGOLAZIONI  
ADJUSTABILITY



355°  
25°

INSTALLAZIONE  
APPLICATION

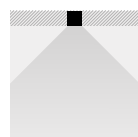

Incasso/Recessed

DISEGNI TECNICI  
TECHNICAL DRAWING

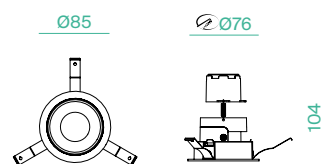

## DEEP\_EVO LESS\_GU10 FIX



CODE	BODY FINISHING	FINISHING REFLECTOR	BASE	KG	PRICE
71657	Bianco/White	Bianco/White	GU10	0,13	27,90
71658	Bianco/White	Nero/White	GU10	0,13	27,90

## DEEP\_EVO LESS\_GU10 ADJUSTABLE



CODE	BODY FINISHING	FINISHING REFLECTOR	BASE	KG	PRICE
71660	Bianco/White	Bianco/White	GU10	0,13	27,90
71661	Bianco/White	Nero/White	GU10	0,13	27,90

REGOLAZIONI  
ADJUSTABILITY



355°  
25°

INSTALLAZIONE  
APPLICATION

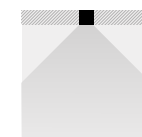

Incasso/Recessed

DISEGNI TECNICI  
TECHNICAL DRAWING



DEEP\_EVO  
GRANDE  
FIX



CODE	BODY FINISHING	FINISHING REFLECTOR	MODULI	KG	PRICE
71729	Bianco/White	Bianco/White	Pag. 66-67	0,22	29,70
71730	Bianco/White	Nero/Black	Pag. 66-67	0,22	29,70
71732	Nero/Black	Bianco/White	Pag. 66-67	0,22	29,70
71733	Nero/Black	Nero/Black	Pag. 66-67	0,22	29,70

DEEP\_EVO  
LESS\_GRANDE  
FIX



CODE	BODY FINISHING	FINISHING REFLECTOR	MODULI	KG	PRICE
71741	Bianco/White	Bianco/White	Pag. 66-67	0,24	39,90
71742	Bianco/White	Nero/Black	Pag. 66-67	0,24	39,90

DEEP\_EVO  
GRANDE  
ADJUSTABLE



CODE	BODY FINISHING	FINISHING REFLECTOR	MODULI	KG	PRICE
71735	Bianco/White	Bianco/White	Pag. 66-67	0,22	29,70
71736	Bianco/White	Nero/Black	Pag. 66-67	0,22	29,70
71738	Nero/Black	Bianco/White	Pag. 66-67	0,22	29,70
71739	Nero/Black	Nero/Black	Pag. 66-67	0,22	29,70

REGOLAZIONI  
ADJUSTABILITY



DEEP\_EVO  
LESS\_GRANDE  
ADJUSTABLE



CODE	BODY FINISHING	FINISHING REFLECTOR	MODULI	KG	PRICE
71744	Bianco/White	Bianco/White	Pag. 66-67	0,24	39,90
71745	Bianco/White	Nero/Black	Pag. 66-67	0,24	39,90

REGOLAZIONI  
ADJUSTABILITY



INSTALLAZIONE  
APPLICATION

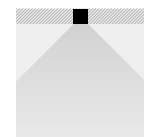

Incasso/Recessed

DISEGNI TECNICI C/ MODULO LED  
TECHNICAL DRAWING W/ LED MODULE

LED Module 20W-24W

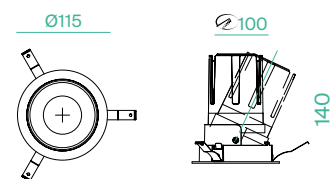

INSTALLAZIONE  
APPLICATION



Incasso/Recessed

DISEGNI TECNICI C/ MODULO LED  
TECHNICAL DRAWING W/ LED MODULE

LED Module 20W-24W

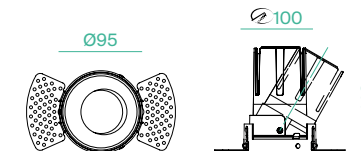

## DEEP\_EVO\_Q FIX/ADJ



CODE	BODY FINISHING	FINISHING REFLECTOR	MODULI	KG	PRICE
71705	Bianco/White	Bianco/White	Pag. 66-67	0,13	15,90
71706	Bianco/White	Nero/Black	Pag. 66-67	0,13	15,90
71708	Nero/Black	Bianco/White	Pag. 66-67	0,13	15,90
71709	Nero/Black	Nero/Black	Pag. 66-67	0,13	15,90

REGOLAZIONI  
ADJUSTABILITY



INSTALLAZIONE  
APPLICATION

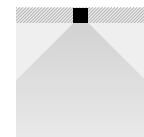

Incasso/Recessed

DISEGNI TECNICI C/ MODULO LED  
TECHNICAL DRAWING W/ LED MODULE

LED Module 9W

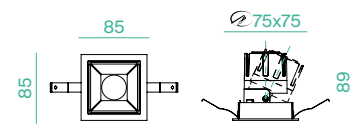

LED Module 12W-15W

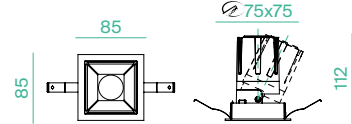

## DEEP\_EVO LESS\_Q FIX/ADJ



CODE	BODY FINISHING	FINISHING REFLECTOR	MODULI	KG	PRICE
71711	Bianco/White	Bianco/White	Pag. 66-67	0,14	23,43
71712	Bianco/White	Nero/Black	Pag. 66-67	0,14	23,43

REGOLAZIONI  
ADJUSTABILITY



INSTALLAZIONE  
APPLICATION

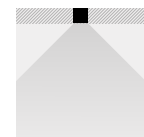

Incasso/Recessed

DISEGNI TECNICI C/ MODULO LED  
TECHNICAL DRAWING W/ LED MODULE

LED Module 9W

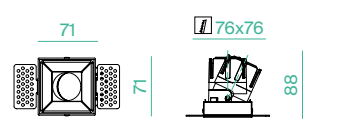

LED Module 12W-15W

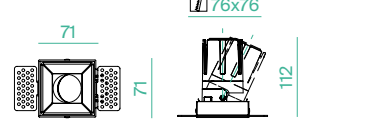

## DEEP\_EVO\_Q\_GU10 FIX/ADJ



CODE	BODY FINISHING	FINISHING REFLECTOR	BASE	KG	PRICE
71714	Bianco/White	Bianco/White	GU10	0,22	19,90
71715	Bianco/White	Nero/Black	GU10	0,22	19,90
71717	Nero/Black	Bianco/White	GU10	0,22	19,90
71718	Nero/Black	Nero/Black	GU10	0,22	19,90

REGOLAZIONI  
ADJUSTABILITY



INSTALLAZIONE  
APPLICATION

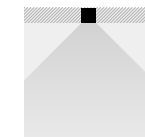

Incasso/Recessed

DISEGNI TECNICI  
TECHNICAL DRAWING

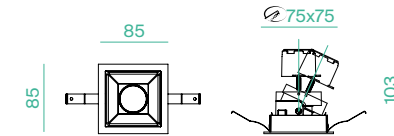

## DEEP\_EVO\_Q GRANDE FIX/ADJ



CODE	BODY FINISHING	FINISHING REFLECTOR	MODULI	KG	PRICE
71723	Bianco/White	Bianco/White	Pag. 66-67	0,24	29,70
71724	Bianco/White	Nero/Black	Pag. 66-67	0,24	29,70
71726	Nero/Black	Bianco/White	Pag. 66-67	0,24	29,70
71727	Nero/Black	Nero/Black	Pag. 66-67	0,24	29,70

REGOLAZIONI  
ADJUSTABILITY



INSTALLAZIONE  
APPLICATION

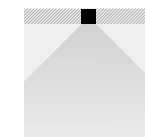

Incasso/Recessed

DISEGNI TECNICI C/ MODULO LED  
TECHNICAL DRAWING W/ LED MODULE

LED Module 20W-24W

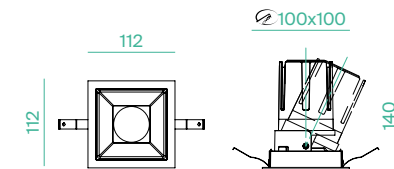

# DEEP\_EVO STD



CODE	BODY FINISHING	FINISHING REFLECTOR	MODULI	KG	PRICE
71600	Bianco/White	Bianco/White	Pag. 66-67	0,08	12,16
71601	Bianco/White	Nero/Black	Pag. 66-67	0,08	12,16
71603	Nero/Black	Bianco/White	Pag. 66-67	0,08	12,16
71604	Nero/Black	Nero/Black	Pag. 66-67	0,08	12,16

## INSTALLAZIONE APPLICATION

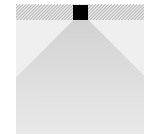

Incasso/Recessed

## DISEGNI TECNICI C/ MODULO LED TECHNICAL DRAWING W/ LED MODULE

LED Module 9W

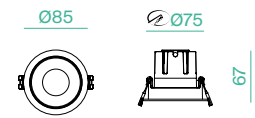

LED Module 12W-15W

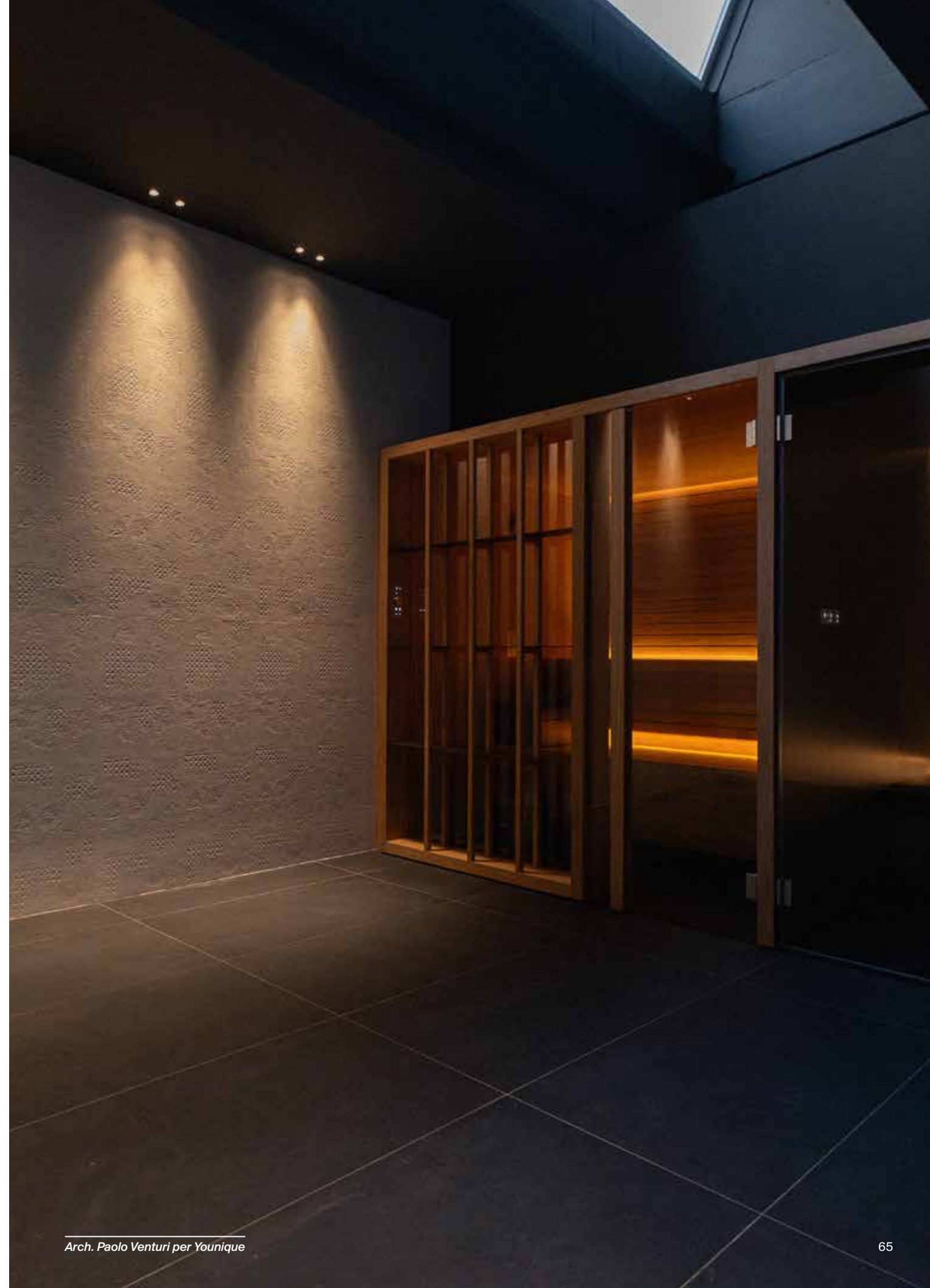
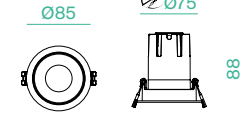

## MODULO LED DEEP\_EVO



LED  
CRI >90  
PF >0,9

CODE	WATT	LUMEN	BEAM	KELVIN	DRIVER	MODE	KG	PRICE
DEEP_EVO								
71606	9W	715	15°	3000K	30-42V 200mA	ON-OFF	0,16	29,00
71607	9W	725	24°	3000K	30-42V 200mA	ON-OFF	0,16	29,00
71608	9W	710	38°	3000K	30-42V 200mA	ON-OFF	0,16	29,00
71609	9W	695	55°	3000K	30-42V 200mA	ON-OFF	0,16	29,00
71610	12W	1015	15°	3000K	30-42V 300mA	ON-OFF	0,23	30,00
71611	12W	1055	24°	3000K	30-42V 300mA	ON-OFF	0,23	30,00
71612	12W	1050	38°	3000K	30-42V 300mA	ON-OFF	0,23	30,00
71613	12W	1000	55°	3000K	30-42V 300mA	ON-OFF	0,23	30,00
71614	15W	1150	15°	3000K	30-42V 350mA	ON-OFF	0,23	31,00
71615	15W	1170	24°	3000K	30-42V 350mA	ON-OFF	0,23	31,00
71616	15W	1155	38°	3000K	30-42V 350mA	ON-OFF	0,23	31,00
71617	15W	1110	55°	3000K	30-42V 350mA	ON-OFF	0,23	31,00
DEEP_EVO GRANDE								
71747	20W	1863	15°	3000K	40V 500mA	ON-OFF	0,34	40,28
71748	20W	1948	24°	3000K	40V 500mA	ON-OFF	0,34	40,28
71749	20W	1909	38°	3000K	40V 500mA	ON-OFF	0,34	40,28
71750	20W	1873	55°	3000K	40V 500mA	ON-OFF	0,34	40,28
71751	24W	2321	15°	3000K	40V 600mA	ON-OFF	0,34	40,95
71752	24W	2314	24°	3000K	40V 600mA	ON-OFF	0,34	40,95
71753	24W	2307	38°	3000K	40V 600mA	ON-OFF	0,34	40,95
71754	24W	2301	55°	3000K	40V 600mA	ON-OFF	0,34	40,95
DEEP_EVO								
71618	9W	715	15°	3000K	30-42V 200mA	1-10V	0,16	45,25
71619	9W	725	24°	3000K	30-42V 200mA	1-10V	0,16	45,25
71620	9W	710	38°	3000K	30-42V 200mA	1-10V	0,16	45,25
71621	9W	695	55°	3000K	30-42V 200mA	1-10V	0,16	45,25
71622	12W	1015	15°	3000K	30-42V 300mA	1-10V	0,23	51,00
71623	12W	1055	24°	3000K	30-42V 300mA	1-10V	0,23	51,00
71624	12W	1050	38°	3000K	30-42V 300mA	1-10V	0,23	51,00
71625	12W	1000	55°	3000K	30-42V 300mA	1-10V	0,23	51,00
71626	15W	1150	15°	3000K	30-42V 350mA	1-10V	0,23	55,50
71627	15W	1170	24°	3000K	30-42V 350mA	1-10V	0,23	55,50

CODE	WATT	LUMEN	BEAM	KELVIN	DRIVER	MODE	KG	PRICE
71628	15W	1155	38°	3000K	30-42V 350mA	1-10V	0,23	55,50
71629	15W	1110	55°	3000K	30-42V 350mA	1-10V	0,23	55,50
71763	9W	715	15°	3000K	30-42V 200mA	DALI/PUSH	0,16	69,00
71764	9W	725	24°	3000K	30-42V 200mA	DALI/PUSH	0,16	69,00
71765	9W	710	38°	3000K	30-42V 200mA	DALI/PUSH	0,16	69,00
71766	9W	695	55°	3000K	30-42V 200mA	DALI/PUSH	0,16	69,00
71767	12W	1015	15°	3000K	30-42V 300mA	DALI/PUSH	0,23	69,25
71768	12W	1055	24°	3000K	30-42V 300mA	DALI/PUSH	0,23	69,25
71769	12W	1050	38°	3000K	30-42V 300mA	DALI/PUSH	0,23	69,25
71770	12W	1000	55°	3000K	30-42V 300mA	DALI/PUSH	0,23	69,25
71771	15W	1150	15°	3000K	30-42V 350mA	DALI/PUSH	0,23	73,00
71772	15W	1170	24°	3000K	30-42V 350mA	DALI/PUSH	0,23	73,00
71773	15W	1155	38°	3000K	30-42V 350mA	DALI/PUSH	0,23	73,00
71774	15W	1110	55°	3000K	30-42V 350mA	DALI/PUSH	0,23	73,00
DEEP_EVO GRANDE								
71755	20W	1863	15°	3000K	40V 500mA	DALI/PUSH	0,34	81,00
71756	20W	1948	24°	3000K	40V 500mA	DALI/PUSH	0,34	81,00
71757	20W	1909	38°	3000K	40V 500mA	DALI/PUSH	0,34	81,00
71758	20W	1873	55°	3000K	40V 500mA	DALI/PUSH	0,34	81,00
71759	24W	2321	15°	3000K	40V 600mA	DALI/PUSH	0,34	83,50
71760	24W	2314	24°	3000K	40V 600mA	DALI/PUSH	0,34	83,50
71761	24W	2307	38°	3000K	40V 600mA	DALI/PUSH	0,34	83,50
71762	24W	2301	55°	3000K	40V 600mA	DALI/PUSH	0,34	83,50



## ACCESSORI ACCESSORIES

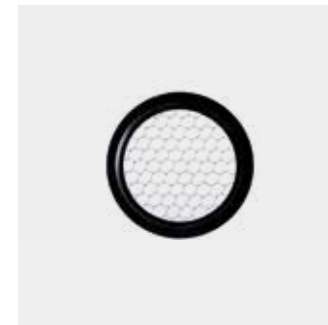

CODE	DESCRIPTION	PRICE
71575	Filtro honeycomb 9W-12W-15W/ Honeycomb filter 9W-12W-15W	4,71
71663	Filtro honeycomb 20W-24W /Honeycomb filter 20W-24W	5,30



## LIGHT\_35



CODE	FINISHING	BASE	WATT	VOLT	KG	PRICE
41281	Bianco/White	GU10	Max 50W	230V 50/60Hz	0,090	13,30
41282	Nero/Black	GU10	Max 50W	230V 50/60Hz	0,090	13,30
41287	Oro/Gold	GU10	Max 50W	230V 50/60Hz	0,090	15,65

### INSTALLAZIONE APPLICATION

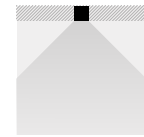

Incasso/Recessed

### DISEGNI TECNICI TECHNICAL DRAWING

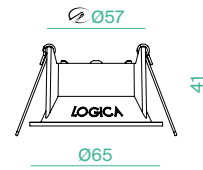

## LIGHT\_50



CODE	FINISHING	BASE	WATT	VOLT	KG	PRICE
41283	Bianco/White	GU10	Max 50W	230V 50/60Hz	0,120	15,25
41284	Nero/Black	GU10	Max 50W	230V 50/60Hz	0,120	15,25
41288	Oro/Gold	GU10	Max 50W	230V 50/60Hz	0,120	19,40

### INSTALLAZIONE APPLICATION

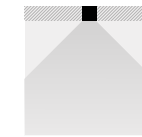

Incasso/Recessed

### DISEGNI TECNICI TECHNICAL DRAWING

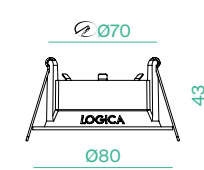

## MODULE\_PRECISE 35



LED BRIDGELUX  
CRI >90  
PF >0,8  
SDCM 3

CODE	WATT	LUMEN 360°/CD	LUMEN 90°	BEAM	KELVIN	VOLT	MODE	KG	PRICE
21721	5,5W	470 / 1000	450	38°	2700K	220-240V	DIMM.	0,085	34,65
21722	5,5W	470 / 1000	450	38°	3000K	220-240V	DIMM.	0,085	34,65

### DISEGNI TECNICI TECHNICAL DRAWING

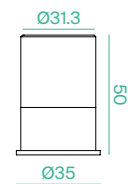

## MODULE\_PRECISE 50



LED BRIDGELUX  
CRI >90  
PF >0,8  
SDCM 3

CODE	WATT	LUMEN 360°/CD	LUMEN 90°	BEAM	KELVIN	VOLT	MODE	KG	PRICE
21723	8,5W	740 / 4600	710	15°	2700K	220-240V	DIMM.	0,172	46,75
21724	8,5W	740 / 3690	710	24°	2700K	220-240V	DIMM.	0,172	46,75
21725	8,5W	740 / 1850	710	38°	2700K	220-240V	DIMM.	0,172	46,75
21726	8,5W	760 / 4750	730	15°	3000K	220-240V	DIMM.	0,172	46,75
21727	8,5W	760 / 3800	730	24°	3000K	220-240V	DIMM.	0,172	46,75
21728	8,5W	760 / 1900	730	38°	3000K	220-240V	DIMM.	0,172	46,75

### DISEGNI TECNICI TECHNICAL DRAWING

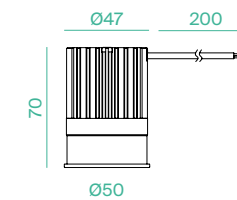

# LIGHT\_111



CODE	FINISHING	BASE	WATT	VOLT	KG	PRICE
41285	Bianco/White	GU10	Max 50W	230V 50/60Hz	0,200	19,60
41286	Nero/Black	GU10	Max 50W	230V 50/60Hz	0,200	19,60
41289	Oro/Gold	GU10	Max 50W	230V 50/60Hz	0,200	29,50

## INSTALLAZIONE APPLICATION

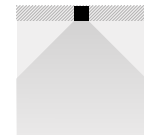

Incasso/Recessed

## DISEGNI TECNICI TECHNICAL DRAWING

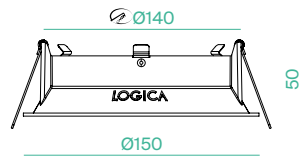

# FULGOR\_IN INCASSO



LED BRIDGELUX  
CRI >90  
PF >0,95

CODE	FINISHING	WATT	LUMEN	WATT LIGHT SOURCE	LUMEN LIGHT SOURCE	BEAM	KELVIN	DRIVER	KG	PRICE
41686	Bianco/White	24W	2220	24W	2640	15°	3000K	30-42V 600mA	0,78	86,90
41688	Nero/Black	24W	2220	24W	2640	15°	3000K	30-42V 600mA	0,78	86,90
41687	Bianco/White	24W	2400	24W	2880	15°	4000K	30-42V 600mA	0,78	86,90
41689	Nero/Black	24W	2400	24W	2880	15°	4000K	30-42V 600mA	0,78	86,90
41690	Bianco/White	24W	2280	24W	2640	24°	3000K	30-42V 600mA	0,78	86,90
41692	Nero/Black	24W	2280	24W	2640	24°	3000K	30-42V 600mA	0,78	86,90
41691	Bianco/White	24W	2480	24W	2880	24°	4000K	30-42V 600mA	0,78	86,90
41693	Nero/Black	24W	2480	24W	2880	24°	4000K	30-42V 600mA	0,78	86,90
41682	Bianco/White	24W	2340	24W	2640	38°	3000K	30-42V 600mA	0,78	86,90
41684	Nero/Black	24W	2340	24W	2640	38°	3000K	30-42V 600mA	0,78	86,90
41683	Bianco/White	24W	2550	24W	2880	38°	4000K	30-42V 600mA	0,78	86,90
41685	Nero/Black	24W	2550	24W	2880	38°	4000K	30-42V 600mA	0,78	86,90
41694	Bianco/White	24W	2310	24W	2640	55°	3000K	30-42V 600mA	0,78	86,90
41696	Nero/Black	24W	2310	24W	2640	55°	3000K	30-42V 600mA	0,78	86,90
41695	Bianco/White	24W	2510	24W	2880	55°	4000K	30-42V 600mA	0,78	86,90
41697	Nero/Black	24W	2510	24W	2880	55°	4000K	30-42V 600mA	0,78	86,90

## INSTALLAZIONE APPLICATION



Incasso/Recessed

## DISEGNI TECNICI TECHNICAL DRAWINGS

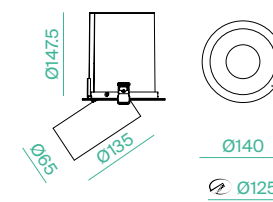

## REGOLAZIONI ADJUSTABILITY



5 YEAR WARRANTY LED IP20 CE

# ACCESSORI ACCESSORIES

CODE	DESCRIPTION	PRICE
71663	Filtro Honeycomb 24W  Honeycomb Filter 24W	5,30

5 YEAR WARRANTY CE IP20 230V 50/60Hz



## BELLATRIX



LED OSRAM  
CRI >90  
PF >0,9  
UGR <19

CODE	FINISHING	WATT	LUMEN	BEAM	KELVIN	KG	PRICE
51011	Bianco/White	10,8W	1234/1278	55°	3000K/4000K	0,15	26,46
51012	Bianco/White	16,2W	1712/1779	55°	3000K/4000K	0,19	28,98
51013	Bianco/White	21,6W	2430/2500	55°	3000K/4000K	0,26	45,96
51014	Bianco/White	27W	2961/3140	55°	3000K/4000K	0,35	55,94
51015	Bianco/White	32,4W	3357/3569	55°	3000K/4000K	0,35	58,46

INSTALLAZIONE  
APPLICATION

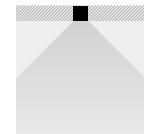

Incasso/Recessed

DISEGNI TECNICI  
TECHNICAL DRAWINGS

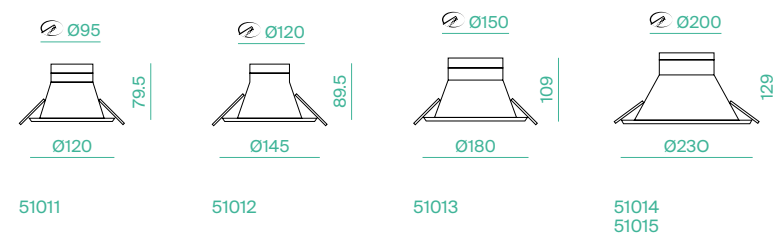

## DRIVER

CODE	DESCRIPTION	VOLT	CURRENT	MODE	PRICE
51016	Driver 12W (10,8W)	36V DC	300mA	ON-OFF	13,10
51017	Driver 18W (16,2W)	36V DC	450mA	ON-OFF	14,62
51018	Driver 23W (21,6W)	36V DC	600mA	ON-OFF	16,13
51019	Driver 28W (27W)	36V DC	750mA	ON-OFF	16,13
51020	Driver 35W (32,4W)	36V DC	900mA	ON-OFF	16,13
51021	Driver Dimming 12W (10,8W)	36V DC	300mA	TRIAC	20,66
51022	Driver Dimming 18W (16,2W)	36V DC	450mA	TRIAC	22,18
51023	Driver Dimming 23W (21,6W)	36V DC	600mA	TRIAC	32,26
51024	Driver Dimming 28W (27W)	36V DC	750mA	TRIAC	32,26
51025	Driver Dimming 35W (32,4W)	36V DC	900mA	TRIAC	38,81
51026	Driver 12W (10,8W)	36V DC	300mA	DALI	42,05
51027	Driver 18W/23W (16,2W / 21,6W)	36V DC	450-600mA	DALI	52,45
51028	Driver 28W/35W (27W / 32,4W)	36V DC	750-900mA	DALI	58,12

## PUNTO



LED BRIDGELUX  
CRI >90

CODE	BODY FINISHING	FINISHING REFLECTOR	WATT	LUMEN	WATT LIGHT SOURCE	LUMEN LIGHT SOURCE	BEAM	KELVIN	KG	PRICE
42686	Bianco/White	Bianco/White	1,6W	100	1,6W	130	30°	3000K	0,07	36,88
42687	Bianco/White	Argento/Silver	1,6W	100	1,6W	130	30°	3000K	0,07	36,88
42688	Bianco/White	Oro/Gold	1,6W	100	1,6W	130	30°	3000K	0,07	36,88
42689	Bianco/White	Nero/Black	1,6W	100	1,6W	130	30°	3000K	0,07	36,88
42693	Nero/Black	Bianco/White	1,6W	100	1,6W	130	30°	3000K	0,07	36,88
42691	Nero/Black	Argento/Silver	1,6W	100	1,6W	130	30°	3000K	0,07	36,88
42692	Nero/Black	Oro/Gold	1,6W	100	1,6W	130	30°	3000K	0,07	36,88
42690	Nero/Black	Nero/Black	1,6W	100	1,6W	130	30°	3000K	0,07	36,88

INSTALLAZIONE  
APPLICATION

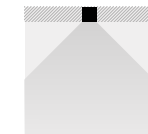

Incasso/Recessed

DISEGNI TECNICI  
TECHNICAL DRAWINGS

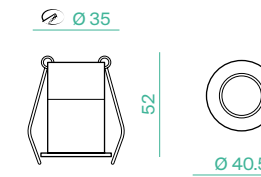

## DRIVER

CODE	VOLT	CURRENT	PF	SIZE	MODE	PRICE
42703	2,52-8V	500mA	>0.5	72x22x22	ON-OFF	6,96

## PUNTO L



LED  
CRI >90

CODE	BODY FINISHING	FINISHING REFLECTOR	WATT	LUMEN	WATT LIGHT SOURCE	LUMEN LIGHT SOURCE	BEAM	KELVIN	KG	PRICE
42694	Bianco/White	Bianco/White	6W	400	6W	500	30°	3000K	0,12	46,48
42695	Bianco/White	Argento/Silver	6W	400	6W	500	30°	3000K	0,12	46,48
42696	Bianco/White	Oro/Gold	6W	400	6W	500	30°	3000K	0,12	46,48
42697	Bianco/White	Nero/Black	6W	400	6W	500	30°	3000K	0,12	46,48
42701	Nero/Black	Bianco/White	6W	400	6W	500	30°	3000K	0,12	46,48
42699	Nero/Black	Argento/Silver	6W	400	6W	500	30°	3000K	0,12	46,48
42700	Nero/Black	Oro/Gold	6W	400	6W	500	30°	3000K	0,12	46,48
42698	Nero/Black	Nero/Black	6W	400	6W	500	30°	3000K	0,12	46,48

### INSTALLAZIONE APPLICATION

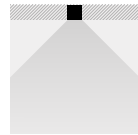

Incasso/Recessed

### DISEGNI TECNICI TECHNICAL DRAWINGS

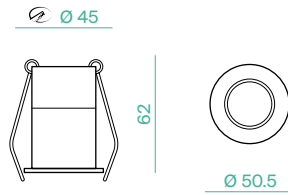

## DRIVER

CODE	VOLT	CURRENT	PF	SIZE	MODE	PRICE
42704	12-26V	350mA	0.95	110x40x23	TRIAC Dimming	16,39
42705	9-18V	350mA	0.95	85x40x23	ON-OFF	11,33

## OCCHIO

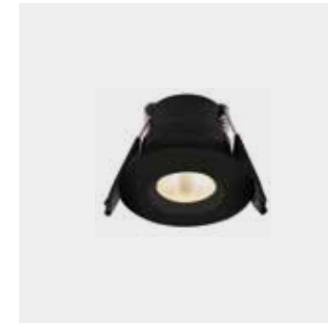

LED  
CRI >90

41063 - 41064

41065 - 41066

CODE	FINISHING	WATT	LUMEN	WATT LIGHT SOURCE	LUMEN LIGHT SOURCE	BEAM	KELVIN	KG	PRICE
41063	Bianco/White	3,5W	250	3,5W	380	60°	3000K	0,06	28,14
41064	Nero/Black	3,5W	250	3,5W	380	60°	3000K	0,06	28,14
41065	Bianco/White	3,5W	250	3,5W	380	60°	3000K	0,06	30,26
41066	Nero/Black	3,5W	250	3,5W	380	60°	3000K	0,06	30,26

### INSTALLAZIONE APPLICATION

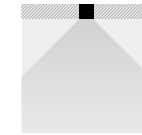

Incasso/Recessed

### DISEGNI TECNICI TECHNICAL DRAWINGS



41063  
41064

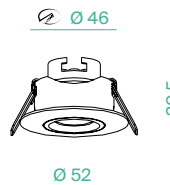

41065  
41066

### REGOLAZIONI ADJUSTABILITY



## DRIVER

CODE	VOLT	CURRENT	PF	SIZE	MODE	PRICE
12557	7-14V	300mA	>0.5	53x27x21	ON-OFF	11,68
12556	6-12V	300mA	>0.5	40x32x20	PHASE-CUT DIMMING	17,58

## MINI 20



LED  
CRI >80

CODE	FINISHING	WATT	LUMEN	WATT LIGHT SOURCE	LUMEN LIGHT SOURCE	BEAM	KELVIN	KG	PRICE
42737	Bianco/White	1,2W	92	1,2W	120	20°	3000K	0,04	18,29
42738	Nero/Black	1,2W	92	1,2W	120	20°	3000K	0,04	18,29

INSTALLAZIONE  
APPLICATION



Incasso/Recessed

DISEGNI TECNICI  
TECHNICAL DRAWINGS

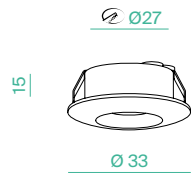

## DRIVER

CODE	VOLT	CURRENT	PF	SIZE	MODE	PRICE
42743	2-5V	350mA	0.5	53x31x21	ON-OFF	10,97

## MINI 105

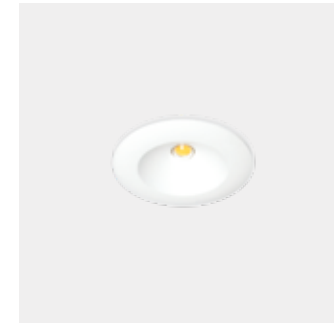

LED  
CRI >80

CODE	FINISHING	WATT	LUMEN	WATT LIGHT SOURCE	LUMEN LIGHT SOURCE	BEAM	KELVIN	KG	PRICE
42739	Bianco/White	1,2W	71	1,2W	120	105°	3000K	0,03	18,29
42740	Nero/Black	1,2W	71	1,2W	120	105°	3000K	0,03	18,29

INSTALLAZIONE  
APPLICATION

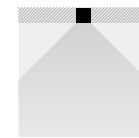

Incasso/Recessed

DISEGNI TECNICI  
TECHNICAL DRAWINGS

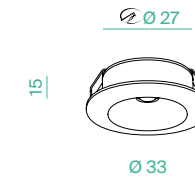

## DRIVER

CODE	VOLT	CURRENT	PF	SIZE	MODE	PRICE
42743	2-5V	350mA	0.5	53x31x21	ON-OFF	10,97

## MINI 60



LED  
CRI OSRAM  
>80

CODE	FINISHING	WATT	LUMEN	WATT LIGHT SOURCE	LUMEN LIGHT SOURCE	BEAM	KELVIN	KG	PRICE
42741	Bianco/White	1,2W	94	1,2W	120	60°	3000K	0,03	18,29
42742	Nero/Black	1,2W	94	1,2W	120	60°	3000K	0,03	18,29

### INSTALLAZIONE APPLICATION

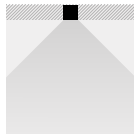

Incasso/Recessed

### DISEGNI TECNICI TECHNICAL DRAWINGS

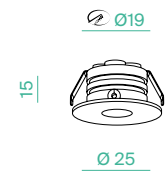

## DRIVER

CODE	VOLT	CURRENT	PF	SIZE	MODE	PRICE
42743	2-5V	350mA	0.5	53x31x21	ON-OFF	10,97

## ZEUS



LED  
CRI EPISTAR  
>80

CODE	FINISHING	WATT	LUMEN	WATT LIGHT SOURCE	LUMEN LIGHT SOURCE	BEAM	KELVIN	KG	PRICE
42745	Bianco/White	3W	285	3W	360	90°	3000K	0,07	20,64
42744	Nero/Black	3W	285	3W	360	90°	3000K	0,07	20,64

### INSTALLAZIONE APPLICATION

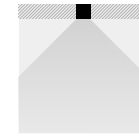

Incasso/Recessed

### DISEGNI TECNICI TECHNICAL DRAWINGS



## DRIVER

CODE	VOLT	CURRENT	PF	SIZE	MODE	PRICE
12557	7-14V	300mA	>0.5	53x27x21	ON-OFF	11,68
12556	6-12V	300mA	>0.5	40x32x20	PHASE-CUT DIMMING	17,58

## AQUA\_EVO COB



LED HONGLI  
CRI >80  
PF >0,7  
SDCM <6

CODE	FINISHING	WATT	LUMEN	LUMEN LIGHT SOURCE	BEAM	KELVIN	KG	PRICE
40624	Bianco/White	8W	800	750 (90°)	60°	2700/3000/4000K	1,98	35,50

### INSTALLAZIONE APPLICATION

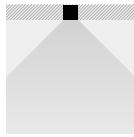

Incasso/Recessed

### DISEGNI TECNICI TECHNICAL DRAWINGS

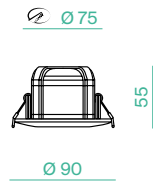

## AQUA\_EVO SMD

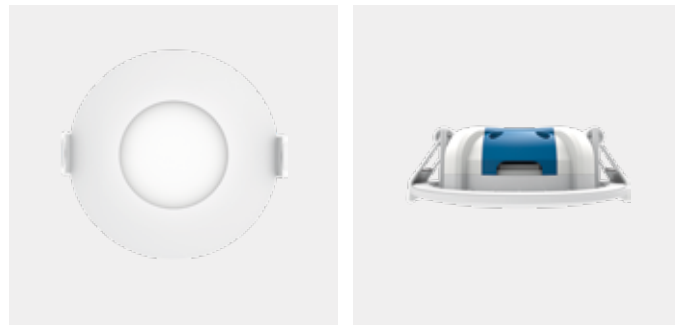

LED HONGLI  
CRI >80  
PF >0,7  
SDCM <6

CODE	FINISHING	WATT	LUMEN	LUMEN LIGHT SOURCE	BEAM	KELVIN	KG	PRICE
40619	Bianco/White	6W	540	420 (120°)	110°	2700/3000/4000K	1,22	21,06

### INSTALLAZIONE APPLICATION

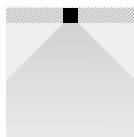

Incasso/Recessed

### DISEGNI TECNICI TECHNICAL DRAWINGS

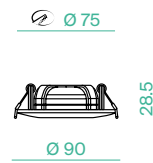

## FRAME



Lampadina esclusa / Bulb not included

CODE	FINISHING	BASE	WATT	VOLT	SIZE	KG	PRICE
53421/GU10	Bianco/White	GU10	Max 50W	230V 50/60Hz	118x118x110	0,60	40,10
53426/GU10	Nero/Black	GU10	Max 50W	230V 50/60Hz	118x118x110	0,60	40,10

### INSTALLAZIONE APPLICATION

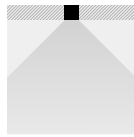

Incasso/Recessed

### DISEGNI TECNICI TECHNICAL DRAWINGS

106x106

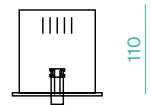

118x118

### REGOLAZIONI ADJUSTABILITY



±45°



## FRAME



Lampadina esclusa / Bulb not included

CODE	FINISHING	BASE	WATT	VOLT	SIZE	KG	PRICE
53425/GU10	Bianco/White	GU10	Max 3x50W	230V 50/60Hz	315x118x110	1,00	91,38
53428/GU10	Nero/Black	GU10	Max 3x50W	230V 50/60Hz	315x118x110	1,00	91,38

### INSTALLAZIONE APPLICATION

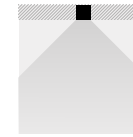

Incasso/Recessed

### DISEGNI TECNICI TECHNICAL DRAWINGS

303x106

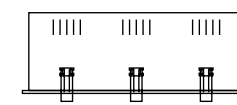

315x118

### REGOLAZIONI ADJUSTABILITY



±45°



## FRAME



Lampadina esclusa / Bulb not included

CODE	FINISHING	BASE	WATT	VOLT	SIZE	KG	PRICE
53423/GU10	Bianco/White	GU10	Max 2x50W	230V 50/60Hz	223x118x110	0,80	65,74
53427/GU10	Nero/Black	GU10	Max 2x50W	230V 50/60Hz	223x118x110	0,80	65,74

### INSTALLAZIONE APPLICATION

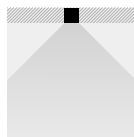

Incasso/Recessed

### DISEGNI TECNICI TECHNICAL DRAWINGS

211x106

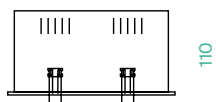

223x118

### REGOLAZIONI ADJUSTABILITY



±45°



## FRAME 111



Lampadina esclusa / Bulb not included

CODE	FINISHING	BASE	WATT	VOLT	SIZE	KG	PRICE
53433/GU10	Bianco/White	AR111 GU10	Max 50W	230V 50/60Hz	191x191x150	1,00	54,05
53429/GU10	Nero/Black	AR111 GU10	Max 50W	230V 50/60Hz	191x191x150	1,00	54,05

### INSTALLAZIONE APPLICATION

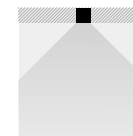

Incasso/Recessed

### DISEGNI TECNICI TECHNICAL DRAWINGS

172x172

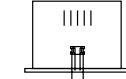

191x191

### REGOLAZIONI ADJUSTABILITY



±45°



## FRAME 111



Lampadina esclusa / Bulb not included

CODE	FINISHING	BASE	WATT	VOLT	SIZE	KG	PRICE
53435/GU10	Bianco/White	AR111 GU10	Max 2x50W	230V 50/60Hz	357x191x150	1,80	89,36
53430/GU10	Nero/Black	AR111 GU10	Max 2x50W	230V 50/60Hz	357x191x150	1,80	89,36

### INSTALLAZIONE APPLICATION

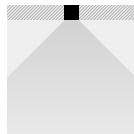

Incasso/Recessed

### DISEGNI TECNICI TECHNICAL DRAWINGS

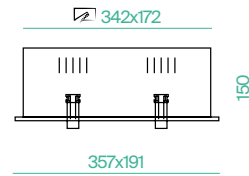

### REGOLAZIONI ADJUSTABILITY



## FRAMELESS



Lampadina esclusa / Bulb not included

CODE	FINISHING	BASE	WATT	VOLT	SIZE	KG	PRICE
53448B/GU10	Bianco/White	GU10	Max 50W	230V 50/60Hz	97x97x120	0,80	47,54
53448/GU10	Nero/Black	GU10	Max 50W	230V 50/60Hz	97x97x120	0,80	47,54

### INSTALLAZIONE APPLICATION



Incasso/Recessed

### DISEGNI TECNICI TECHNICAL DRAWINGS

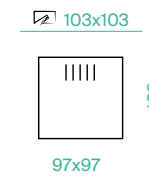

### REGOLAZIONI ADJUSTABILITY



## FRAME 111



Lampadina esclusa / Bulb not included

CODE	FINISHING	BASE	WATT	VOLT	SIZE	KG	PRICE
53437/GU10	Bianco/White	AR111 GU10	Max 3x50W	230V 50/60Hz	509x191x150	2,40	127,47
53431/GU10	Nero/Black	AR111 GU10	Max 3x50W	230V 50/60Hz	509x191x150	2,40	127,47

### INSTALLAZIONE APPLICATION

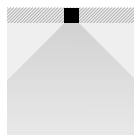

Incasso/Recessed

### DISEGNI TECNICI TECHNICAL DRAWINGS

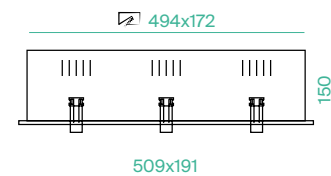

### REGOLAZIONI ADJUSTABILITY



## FRAMELESS



Lampadina esclusa / Bulb not included

CODE	FINISHING	BASE	WATT	VOLT	SIZE	KG	PRICE
53449B/GU10	Bianco/White	GU10	Max 2x50W	230V 50/60Hz	202x97x120	1,00	72,58
53449/GU10	Nero/Black	GU10	Max 2x50W	230V 50/60Hz	223x118x110	1,00	72,58

### INSTALLAZIONE APPLICATION

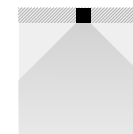

Incasso/Recessed

### DISEGNI TECNICI TECHNICAL DRAWINGS

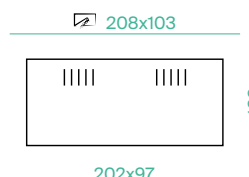

### REGOLAZIONI ADJUSTABILITY



## FRAMELESS



Lampadina esclusa / Bulb not included

CODE	FINISHING	BASE	WATT	VOLT	SIZE	KG	PRICE
53450B/GU10	Bianco/White	GU10	Max 3x50W	230V 50/60Hz	294x97x120	1,40	98,96
53450/GU10	Nero/Black	GU10	Max 3x50W	230V 50/60Hz	294x97x120	1,40	98,96

### INSTALLAZIONE APPLICATION

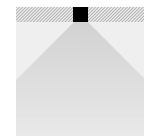

Incasso/Recessed

### DISEGNI TECNICI TECHNICAL DRAWINGS



### REGOLAZIONI ADJUSTABILITY



## FRAMELESS 111



Lampadina esclusa / Bulb not included

CODE	FINISHING	BASE	WATT	VOLT	SIZE	KG	PRICE
53455B/GU10	Bianco/White	AR111 GU10	Max 2x50W	230V 50/60Hz	325x157x150	1,80	99,79
53455/GU10	Nero/Black	AR111 GU10	Max 2x50W	230V 50/60Hz	325x157x150	1,80	99,79

### INSTALLAZIONE APPLICATION

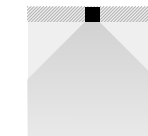

Incasso/Recessed

### DISEGNI TECNICI TECHNICAL DRAWINGS



### REGOLAZIONI ADJUSTABILITY



## FRAMELESS 111



Lampadina esclusa / Bulb not included

CODE	FINISHING	BASE	WATT	VOLT	SIZE	KG	PRICE
53454B/GU10	Bianco/White	AR111 GU10	Max 50W	230V 50/60Hz	157x157x150	1,00	62,37
53454/GU10	Nero/Black	AR111 GU10	Max 50W	230V 50/60Hz	157x157x150	1,00	62,37

### INSTALLAZIONE APPLICATION

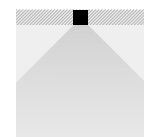

Incasso/Recessed

### DISEGNI TECNICI TECHNICAL DRAWINGS

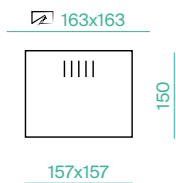

### REGOLAZIONI ADJUSTABILITY



## FRAMELESS 111



Lampadina esclusa / Bulb not included

CODE	FINISHING	BASE	WATT	VOLT	SIZE	KG	PRICE
53456B/GU10	Bianco/White	AR111 GU10	Max 3x50W	230V 50/60Hz	477x157x150	2,40	132,69
53456/GU10	Nero/Black	AR111 GU10	Max 3x50W	230V 50/60Hz	477x157x150	2,40	132,69

### INSTALLAZIONE APPLICATION

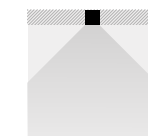

Incasso/Recessed

### DISEGNI TECNICI TECHNICAL DRAWINGS



### REGOLAZIONI ADJUSTABILITY





# WIZARD



Lampadina esclusa / Bulb not included

CODE	FINISHING	BASE	WATT	VOLT	KG	PRICE
42749	Bianco/White	GU10	Max 50W	230V 50/60Hz	0,20	23,48
42750	Nero/Black	GU10	Max 50W	230V 50/60Hz	0,20	23,48
42747	Bianco/White	AR111 GU10	Max 50W	230V 50/60Hz	0,43	32,91
42748	Nero/Black	AR111 GU10	Max 50W	230V 50/60Hz	0,43	32,91

## INSTALLAZIONE APPLICATION

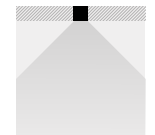

Incasso/Recessed

## DISEGNI TECNICI TECHNICAL DRAWINGS

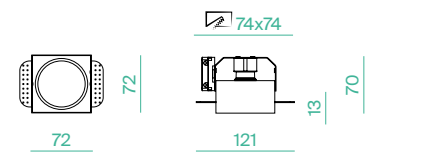

42749  
42750

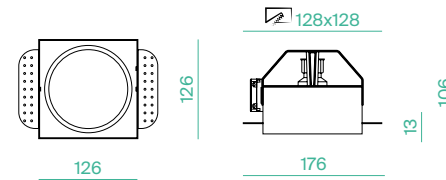

42747  
42748

## REGOLAZIONI ADJUSTABILITY



# A+B SOSPENSIONE DALI-PUSH



LED EPISTAR  
CRI >90  
PF >0.9  
SDCM <6  
UGR <16

CODE	FINISHING	WATT	LUMEN	WATT LIGHT SOURCE	LUMEN LIGHT SOURCE	BEAM	KELVIN	DRIVER	MODE	KG	PRICE
41885	Bianco/White	↓ 26W+ ↑ 12W	2412+1471	26W+11,6W	3236+1501	90°+120°	3000K	38W 30-40V 1050mA	ON-OFF, DALI, PUSH	4,00	407,76
41887	Bianco/White	↓ 26W+ ↑ 12W	2629+1603	26W+11,6W	3603+1636	90°+120°	4000K	38W 30-40V 1050mA	ON-OFF, DALI, PUSH	4,00	407,76
41886	Bianco/White	↓ 38W+ ↑ 20W	3570+2317	36W+20W	4109+2685	90°+120°	3000K	38W 30-40V 1050mA + 20W 30-40V 500mA	ON-OFF, DALI, PUSH	5,20	551,15
41888	Bianco/White	↓ 38W+ ↑ 20W	3892+2525	36W+20W	4782+2926	90°+120°	4000K	38W 30-40V 1050mA + 20W 30-40V 500mA	ON-OFF, DALI, PUSH	5,20	551,15

## INSTALLAZIONE APPLICATION

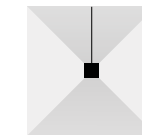

Sospensione/  
Suspension

## DISEGNI TECNICI TECHNICAL DRAWINGS

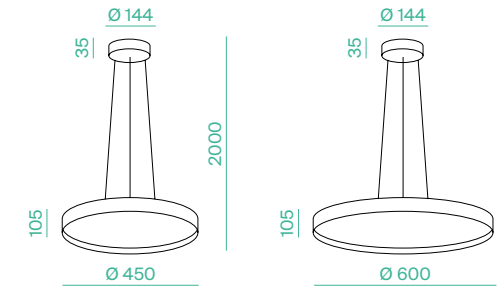

41885  
41887

41886  
41888

## SHANGHAI\_30



LED CREE  
CRI >90  
PF >0.5

CODE	FINISHING	WATT	LUMEN	WATT LIGHT SOURCE	LUMEN LIGHT SOURCE	BEAM	KELVIN	KG	PRICE
43160	Nero/Black	6W	256	4,8W	450	15°	3000K	0,55	93,20
43161	Bianco/White	6W	256	4,8W	450	15°	3000K	0,55	93,20

### INSTALLAZIONE APPLICATION

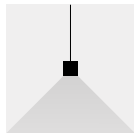

Sospensione/  
Suspension

### DISEGNI TECNICI TECHNICAL DRAWINGS

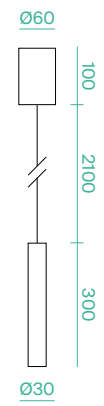

## SHANGHAI\_50



LED EPISTAR  
CRI >90  
PF >0.9  
SDCM <6  
UGR <16

CODE	FINISHING	WATT	LUMEN	WATT LIGHT SOURCE	LUMEN LIGHT SOURCE	BEAM	KELVIN	KG	PRICE
43162	Nero/Black	6W	256	4,8W	450	15°	3000K	0,55	105,00
43163	Bianco/White	6W	256	4,8W	450	15°	3000K	0,55	105,00

### INSTALLAZIONE APPLICATION

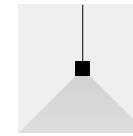

Sospensione/  
Suspension

### DISEGNI TECNICI TECHNICAL DRAWINGS

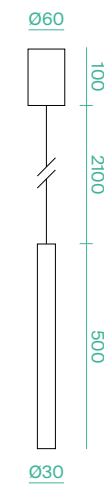

# CYL SOSP



LED BRIDGELUX  
CRI >90  
PF >0.5

CODE	FINISHING	WATT	LUMEN	WATT LIGHT SOURCE	LUMEN LIGHT SOURCE	BEAM	KELVIN	KG	PRICE
41707	Nero/Black	12W	890	12W	1680	55°	3000K	0,86	110,19
41708	Bianco/White	12W	890	12W	1680	55°	3000K	0,86	110,19

## INSTALLAZIONE APPLICATION

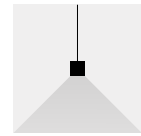

Sospensione/  
Suspension

## DISEGNI TECNICI TECHNICAL DRAWINGS

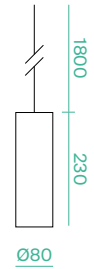

Ø80



# A+B SOFFITTO DALI-PUSH

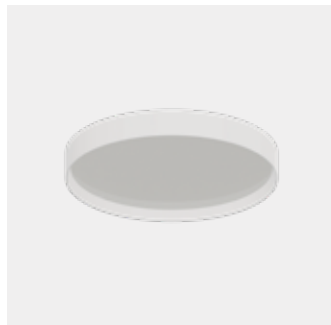

LED EPISTAR  
CRI >90  
PF >0.9  
SDCM <6  
UGR <16

CODE	FINISHING	WATT	LUMEN	WATT LIGHT SOURCE	LUMEN LIGHT SOURCE	BEAM	KELVIN	DRIVER	KG	PRICE
41889	Bianco/White	↓ 26W+ ↑ 12W	2412+1471	26W+11,6W	3236+1501	90°+120°	3000K	38W 30-40V 1050mA	3,60	364,95
41891	Bianco/White	↓ 26W+ ↑ 12W	2412+1471	26W+11,6W	3236+1501	90°+120°	4000K	38W 30-40V 1050mA	3,60	364,95
41890	Bianco/White	↓ 38W+ ↑ 20W	3570+2317	36W+20W	4109+2685	90°+120°	3000K	38W 30-40V 1050mA + 20W 30-40V 500mA	4,80	514,27
41892	Bianco/White	↓ 38W+ ↑ 20W	3570+2317	36W+20W	4109+2685	90°+120°	4000K	38W 30-40V 1050mA + 20W 30-40V 500mA	4,80	514,27

## INSTALLAZIONE APPLICATION



Soffitto/Ceiling

## DISEGNI TECNICI TECHNICAL DRAWINGS

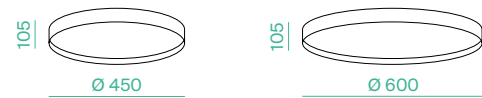

41889  
41891

41890  
41892



# FULGOR SOFFITTO/ PARETE



LED EPISTAR  
CRI >90  
PF >0.9

CODE	FINISHING	WATT	LUMEN	WATT LIGHT SOURCE	LUMEN LIGHT SOURCE	BEAM	KELVIN	VOLT	KG	PRICE
41869	Bianco/White	15W	1560	14,8W	1710	15°	3000K	36-38V 350mA	0,60	64,62
41877	Nero/Black	15W	1560	14,8W	1710	15°	3000K	36-38V 350mA	0,60	64,62
41873	Bianco/White	15W	1557	14,8W	1834	15°	4000K	36-38V 350mA	0,60	64,62
41881	Nero/Black	15W	1557	14,8W	1834	15°	4000K	36-38V 350mA	0,60	64,62
41870	Bianco/White	15W	1574	14,8W	1710	24°	3000K	36-38V 350mA	0,60	64,62
41878	Nero/Black	15W	1574	14,8W	1710	24°	3000K	36-38V 350mA	0,60	64,62
41874	Bianco/White	15W	1584	14,8W	1834	24°	4000K	36-38V 350mA	0,60	64,62
41882	Nero/Black	15W	1584	14,8W	1834	24°	4000K	36-38V 350mA	0,60	64,62
41871	Bianco/White	15W	1591	14,8W	1710	38°	3000K	36-38V 350mA	0,60	64,62
41879	Nero/Black	15W	1591	14,8W	1710	38°	3000K	36-38V 350mA	0,60	64,62
41875	Bianco/White	15W	1585	14,8W	1834	38°	4000K	36-38V 350mA	0,60	64,62
41883	Nero/Black	15W	1585	14,8W	1834	38°	4000K	36-38V 350mA	0,60	64,62
41872	Bianco/White	15W	1509	14,8W	1710	55°	3000K	36-38V 350mA	0,60	64,62
41880	Nero/Black	15W	1509	14,8W	1710	55°	3000K	36-38V 350mA	0,60	64,62
41876	Bianco/White	15W	1531	14,8W	1834	55°	4000K	36-38V 350mA	0,60	64,62
41884	Nero/Black	15W	1531	14,8W	1834	55°	4000K	36-38V 350mA	0,60	64,62

## INSTALLAZIONE APPLICATION

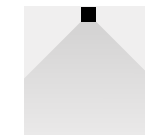

Soffitto/Ceiling



Parete/Wall

## DISEGNI TECNICI TECHNICAL DRAWINGS

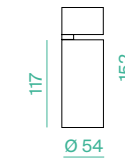

Ø54

## REGOLAZIONI ADJUSTABILITY



# ACCESSORI ACCESSORIES

CODE	DESCRIPTION	PRICE
71575	Filtro Honeycomb 15W  Honeycomb Filter 15W	4,71

SUN\_111  
SOFFITTO/PARETE



Lampadina esclusa / Bulb not included

CODE	FINISHING	BASE	WATT	VOLT	KG	PRICE
41915	Bianco/White	AR111 GU10	Max 50W	230V 50/60Hz	0,44	36,90
41916	Nero/Black	AR111 GU10	Max 50W	230V 50/60Hz	0,44	36,90

INSTALLAZIONE  
APPLICATION

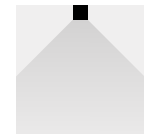

Soffitto/Ceiling



Parete/Wall

DISEGNI TECNICI  
TECHNICAL DRAWINGS

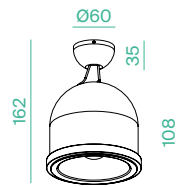

REGOLAZIONI  
ADJUSTABILITY



UNICO DICRO  
SOFFITTO/PARETE



Lampadina esclusa /  
Bulb not included

CODE	FINISHING	BASE	WATT	VOLT	KG	PRICE
40760	Bianco/White	GU10	Max 50W	230V 50/60HZ	0,26	60,17
40761	Nero/Black	GU10	Max 50W	230V 50/60HZ	0,26	60,17

INSTALLAZIONE  
APPLICATION



Soffitto/Ceiling



Parete/Wall

DISEGNI TECNICI  
TECHNICAL DRAWINGS

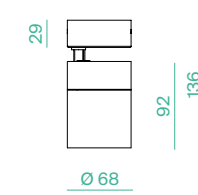

REGOLAZIONI  
ADJUSTABILITY



## KLICK KLAK PUNTIFORME SOFFITTO



LED LIGHTNING  
CRI 90  
PF 0.6  
SDCM 3

CODE	FINISHING	WATT	LUMEN	WATT LIGHT SOURCE	LUMEN LIGHT SOURCE	BEAM	KELVIN	KG	PRICE
41917	Nero/Black	12W	1000	10W	1298	30°	3000K	0,40	65,00
41918	Bianco/White	12W	1000	10W	1298	30°	3000K	0,40	65,00
41919	Nero/Black	22W	2065	20W	2622	30°	3000K	0,60	91,00
41920	Bianco/White	22W	2065	20W	2622	30°	3000K	0,60	91,00
41921	Nero/Black	33W	3170	30W	3911	30°	3000K	0,80	118,00
41922	Bianco/White	33W	3170	30W	3911	30°	3000K	0,80	118,00

### INSTALLAZIONE APPLICATION



Soffitto/Ceiling

### DISEGNI TECNICI TECHNICAL DRAWINGS

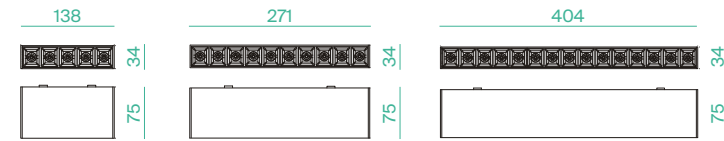

41917  
41918

41919  
41920

41921  
41922



## CYL SOFFITTO



LED BRIDGELUX  
CRI >90  
PF >0.5

CODE	FINISHING	WATT	LUMEN	WATT LIGHT SOURCE	LUMEN LIGHT SOURCE	BEAM	KELVIN	KG	PRICE
41706	Bianco/White	12W	890	12W	1680	55°	3000K	0,66	89,84
41705	Nero/Black	12W	890	12W	1680	55°	3000K	0,66	89,84

### INSTALLAZIONE APPLICATION



Soffitto/Ceiling

### DISEGNI TECNICI TECHNICAL DRAWINGS

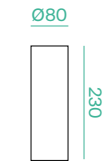

## CYL\_DICRO GU10 SOFFITTO



Lampadina esclusa / Bulb not included

CODE	FINISHING	BASE	VOLT	KG	PRICE
40762	Bianco/White	GU10	230V 50/60HZ	0,25	32,00
40763	Nero/Black	GU10	230V 50/60HZ	0,25	32,00

### INSTALLAZIONE APPLICATION



Soffitto/Ceiling

### DISEGNI TECNICI TECHNICAL DRAWINGS

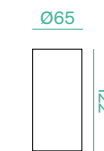

## ALTAIR 9.8W SOFFITTO/PARETE



LED EPISTAR  
CRI >90  
PF >0.9

CODE	FINISHING	WATT	LUMEN	WATT LIGHT SOURCE	LUMEN LIGHT SOURCE	BEAM	KELVIN	KG	PRICE
42735	Bianco/White	9,8W	733	9,8W	940	36°	3000K	0,36	76,68
42736	Nero/Black	9,8W	733	9,8W	940	36°	3000K	0,36	76,68

### INSTALLAZIONE APPLICATION

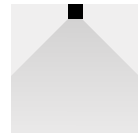

Soffitto/Ceiling

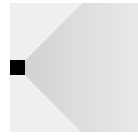

Parete/Wall

### DISEGNI TECNICI TECHNICAL DRAWINGS

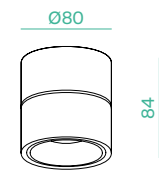

### REGOLAZIONI ADJUSTABILITY



## ALTAIR 14W SOFFITTO/PARETE

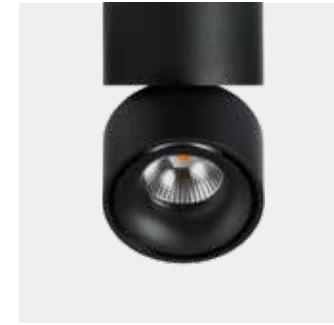

LED EPISTAR  
CRI >90  
PF >0.9

CODE	FINISHING	WATT	LUMEN	WATT LIGHT SOURCE	LUMEN LIGHT SOURCE	BEAM	KELVIN	KG	PRICE
42751	Bianco/White	14W	1050	14W	1400	36°	3000K	0,67	88,48
42752	Nero/Black	14W	1050	14W	1400	36°	3000K	0,67	88,48

### INSTALLAZIONE APPLICATION

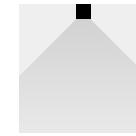

Soffitto/Ceiling

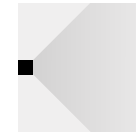

Parete/Wall

### DISEGNI TECNICI TECHNICAL DRAWINGS

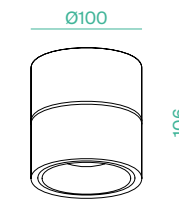

### REGOLAZIONI ADJUSTABILITY



## BOX DICRO



Lampadina esclusa / Bulb not included

CODE	FINISHING	BASE	WATT	VOLT	KG	PRICE
43166	Nero/Black	GU10	MAX 50W	100-240V	0,57	28,80
43167	Bianco/White	GU10	MAX 50W	100-240V	0,57	28,80

### INSTALLAZIONE APPLICATION

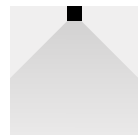

Soffitto/Ceiling

### DISEGNI TECNICI TECHNICAL DRAWINGS

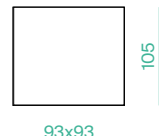

93x93

### REGOLAZIONI ADJUSTABILITY



±30°



## CONTAINER



Lampadina esclusa / Bulb not included

CODE	FINISHING	BASE	WATT	VOLT	SIZE	KG	PRICE
56900/230	Interno nero / Inside black	GU10	MAX 50W	100-240V	120x120x120	1,40	135,52
57900/230	Interno bianco / Inside white	GU10	MAX 50W	100-240V	120x120x120	1,40	135,52

### INSTALLAZIONE APPLICATION

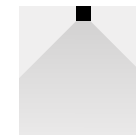

Soffitto/Ceiling

### DISEGNI TECNICI TECHNICAL DRAWINGS

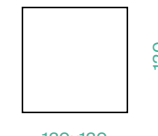

120x120

### REGOLAZIONI ADJUSTABILITY



±45°



## BOX 111



Lampadina esclusa / Bulb not included

CODE	FINISHING	BASE	WATT	VOLT	KG	PRICE
43164	Nero/Black	AR111 GU10	MAX 20W	100-240V	1,10	69,00
43165	Bianco/White	AR111 GU10	MAX 20W	100-240V	1,10	69,00

### INSTALLAZIONE APPLICATION

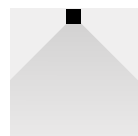

Soffitto/Ceiling

### DISEGNI TECNICI TECHNICAL DRAWINGS

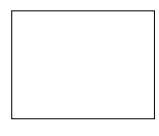

164x164

### REGOLAZIONI ADJUSTABILITY



±30°



## CONTAINER



Lampadina esclusa / Bulb not included

CODE	FINISHING	BASE	WATT	VOLT	SIZE	KG	PRICE
56901/230	Interno nero / Inside black	GU10	MAX 2x50W	100-240V	225x120x120	2,20	184,16
57901/230	Interno bianco / Inside white	GU10	MAX 2x50W	100-240V	225x120x120	2,20	184,16

### INSTALLAZIONE APPLICATION

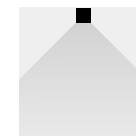

Soffitto/Ceiling

### DISEGNI TECNICI TECHNICAL DRAWINGS

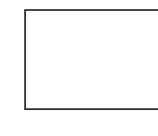

225x120

### REGOLAZIONI ADJUSTABILITY



±45°



## CONTAINER



Lampadina esclusa / Bulb not included

CODE	FINISHING	BASE	WATT	VOLT	SIZE	KG	PRICE
56902/230	Interno nero / Inside black	GU10	MAX 3x50W	100-240V	317x120x120	3,60	209,64
57902/230	Interno bianco / Inside white	GU10	MAX 3x50W	100-240V	317x120x120	3,60	209,64

### INSTALLAZIONE APPLICATION



Soffitto/Ceiling

### DISEGNI TECNICI TECHNICAL DRAWINGS

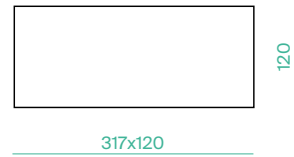

### REGOLAZIONI ADJUSTABILITY



## CONTAINER 111



Lampadina esclusa / Bulb not included

CODE	FINISHING	BASE	WATT	VOLT	SIZE	KG	PRICE
56904/230	Interno nero / Inside black	AR111 GU10	MAX 2x50W	100-240V	225x120x120	3,20	203,84
57904/230	Interno bianco / Inside white	AR111 GU10	MAX 2x50W	100-240V	225x120x120	3,20	203,84

### INSTALLAZIONE APPLICATION

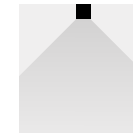

Soffitto/Ceiling

### DISEGNI TECNICI TECHNICAL DRAWINGS



### REGOLAZIONI ADJUSTABILITY



## CONTAINER 111



Lampadina esclusa / Bulb not included

CODE	FINISHING	BASE	WATT	VOLT	SIZE	KG	PRICE
53903/230	Interno nero / Inside black	AR111 GU10	MAX 50W	100-240V	120x120x120	2,00	163,26
57903/230	Interno bianco / Inside white	AR111 GU10	MAX 50W	100-240V	120x120x120	2,00	163,26

### INSTALLAZIONE APPLICATION



Soffitto/Ceiling

### DISEGNI TECNICI TECHNICAL DRAWINGS

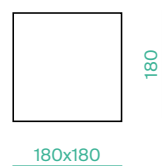

### REGOLAZIONI ADJUSTABILITY



## CONTAINER 111



Lampadina esclusa / Bulb not included

CODE	FINISHING	BASE	WATT	VOLT	SIZE	KG	PRICE
56905/230	Interno nero / Inside black	AR111 GU10	MAX 3x50W	100-240V	317x120x120	5,20	260,60
57905/230	Interno bianco / Inside white	AR111 GU10	MAX 3x50W	100-240V	317x120x120	5,20	260,60

### INSTALLAZIONE APPLICATION



Soffitto/Ceiling

### DISEGNI TECNICI TECHNICAL DRAWINGS

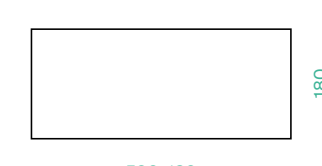

### REGOLAZIONI ADJUSTABILITY





# MINIMA



LED SMD-RUNLITE  
 CRI >90  
 PF >0.9  
 SDCM 5

CODE	FINISHING	WATT	LUMEN	WATT LIGHT SOURCE	LUMEN LIGHT SOURCE	BEAM	KELVIN	MODE	KG	PRICE
42531	Bianco/White	14W	1420	11,88W	2100	107°	3000K	Dimm. Taglio di fase/Phase cut dimming	0,70	138,05
42532	Nero/Black	14W	1420	11,88W	2100	107°	3000K	Dimm. Taglio di fase/Phase cut dimming	0,70	138,05
42706	Bianco/White	18W	1522	15,12W	2700	107°	3000K	Dimm. Taglio di fase/Phase cut dimming	0,91	184,90
42707	Nero/Black	18W	1522	15,12W	2700	107°	3000K	Dimm. Taglio di fase/Phase cut dimming	0,91	184,90
42708	Bianco/White	24W	2004	20,52W	3600	107°	3000K	Dimm. Taglio di fase/Phase cut dimming	1,13	215,10
42709	Nero/Black	24W	2004	20,52W	3600	107°	3000K	Dimm. Taglio di fase/Phase cut dimming	1,13	215,10

## INSTALLAZIONE APPLICATION



Parete/Wall

## DISEGNI TECNICI TECHNICAL DRAWINGS

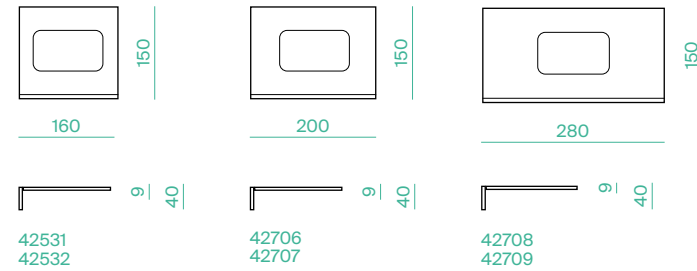

# ESSENTIAL



LED LTWG  
 CRI >90  
 PF 0.9  
 SDCM 3  
 UGR <25

CODE	FINISHING	WATT	LUMEN	WATT LIGHT SOURCE	LUMEN LIGHT SOURCE	BEAM	KELVIN	MODE	KG	PRICE
43170	Bianco/White	20W	1209	18,9W	1620	110°	3000K	Dimm. Taglio di fase/Phase cut dimming	0,50	99,50
43171	Nero/Black	20W	1209	18,9W	1620	110°	3000K	Dimm. Taglio di fase/Phase cut dimming	0,50	99,50
43172	Bianco/White	30W	1850	28,29W	2432	110°	3000K	Dimm. Taglio di fase/Phase cut dimming	0,60	137,80
43173	Nero/Black	30W	1850	28,29W	2432	110°	3000K	Dimm. Taglio di fase/Phase cut dimming	0,60	137,80

## INSTALLAZIONE APPLICATION



Parete/Wall

## DISEGNI TECNICI TECHNICAL DRAWINGS

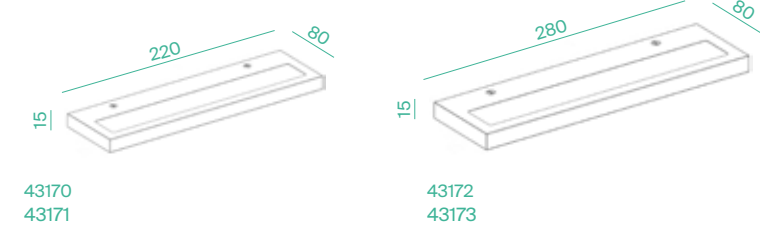

## SU&GIU



LED LUMINUS CXM-6  
CRI >90  
PF 0.9  
SDCM 3  
UGR <25

CODE	FINISHING	WATT	LUMEN	WATT LIGHT SOURCE	LUMEN LIGHT SOURCE	BEAM	KELVIN	KG	PRICE
43174	Bianco/White	5W+5W	463+463	4,5W+4,5W	620+620	38°	3000K	0,70	115,90
43175	Nero/Black	5W+5W	463+463	4,5W+4,5W	620+620	38°	3000K	0,70	115,90

### INSTALLAZIONE APPLICATION



Parete/Wall

### DISEGNI TECNICI TECHNICAL DRAWINGS

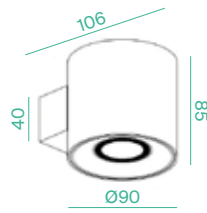

## BLOC\_EVO



LED SANAN  
CRI >80  
PF 0.5

CODE	FINISHING	WATT	LUMEN	WATT LIGHT SOURCE	LUMEN LIGHT SOURCE	KELVIN	DRIVER	KG	PRICE
40617	Nero/Black	11W	804	9W	1200	3000K	300mA 22-40V	0,66	74,74
40615	Bianco/White	11W	804	9W	1200	3000K	300mA 22-40V	0,66	74,74

### INSTALLAZIONE APPLICATION



Parete/Wall

### DISEGNI TECNICI TECHNICAL DRAWINGS

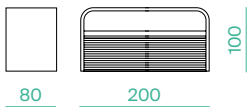

## DUMBO FLEX



LED SEOUL SC  
CRI >80  
PF >0.5

CODE	FINISHING	WATT	LUMEN	WATT LIGHT SOURCE	LUMEN LIGHT SOURCE	KELVIN	DRIVER	VOLT	KG	PRICE
42619	Nero/Black	3W	150	2,76W	154	3000K	700mA	6V	0,30	60,41
42620	Cromo/Chrome	3W	150	2,76W	154	3000K	700mA	6V	0,30	64,18

### INSTALLAZIONE APPLICATION



Parete/Wall

### DISEGNI TECNICI TECHNICAL DRAWINGS

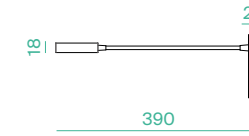

### REGOLAZIONI ADJUSTABILITY



## DUMBO

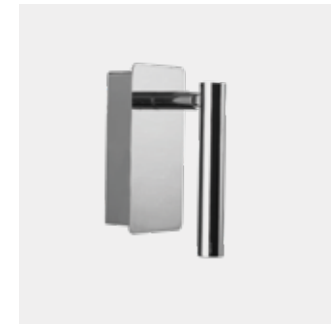

LED SEOUL SC  
CRI >80  
PF >0.5

CODE	FINISHING	WATT	LUMEN	WATT LIGHT SOURCE	LUMEN LIGHT SOURCE	KELVIN	DRIVER	VOLT	KG	PRICE
42621	Nero/Black	3W	150	2,76W	154	3000K	700mA	6V	0,26	52,86
42622	Cromo/Chrome	3W	150	2,76W	154	3000K	700mA	6V	0,26	56,63

### INSTALLAZIONE APPLICATION



Parete/Wall

### DISEGNI TECNICI TECHNICAL DRAWINGS

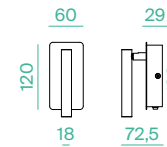

### REGOLAZIONI ADJUSTABILITY



## WALL INCASSO



CODE	FINISHING	DESCRIPRION	SIZE	KG	PRICE
21388	Bianco/White	Profilo /Profile	2mt	1,65	58,46

### INSTALLAZIONE APPLICATION

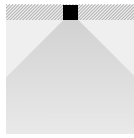

Incasso/Recessed

### DISEGNI TECNICI TECHNICAL DRAWINGS

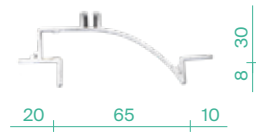

## ONDA INCASSO



CODE	FINISHING	DESCRIPTION	SIZE	KG	PRICE
21385	Bianco/White	Profilo / Profile	2mt	1,80	59,18

### INSTALLAZIONE APPLICATION

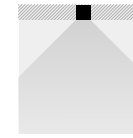

Incasso/Recessed

### DISEGNI TECNICI TECHNICAL DRAWINGS

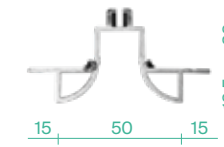

## ACCESSORI ACCESSORIES



21301

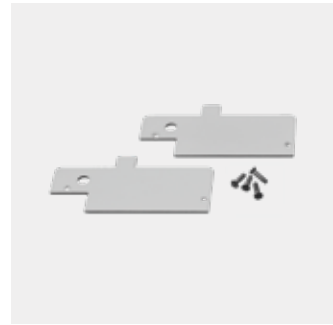

21389

CODE	FINISHING	DESCRIPTION	SIZE	PRICE
21301	Opale/Opal	Schermo / Diffuser	2mt	5,95
21389	Bianco/White	Kit 4 viti + 2 testate di chiusura/ 4 screws + 2 end caps kit		4,67

## ACCESSORI ACCESSORIES



21387

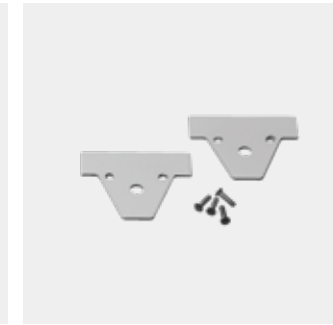

21386

CODE	FINISHING	DESCRIPTION	SIZE	PRICE
21387	Opale/Opal	Schermo / Diffuser	2mt	5,06
21386	Bianco/White	Kit 4 viti + 2 testate di chiusura/ 4 screws + 2 end caps kit		4,41

LINE\_EVO  
SOFFITTO



CODE	FINISHING	DESCRIPTION	SIZE	KG	PRICE
11911	Alluminio/ Aluminium	Profilo / Profile	2mt	1,20	29,09
11912	Bianco/White	Profilo / Profile	2mt	1,20	29,09
11913	Nero/Black	Profilo / Profile	2mt	1,20	29,09
11923	Oro/Gold	Profilo / Profile	2mt	1,20	29,09

INSTALLAZIONE  
APPLICATION

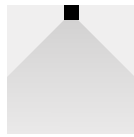

Soffitto/Ceiling

DISEGNI TECNICI  
TECHNICAL DRAWINGS

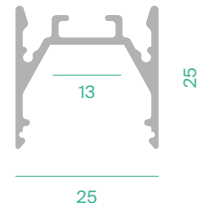

ACCESSORI  
ACCESSORIES

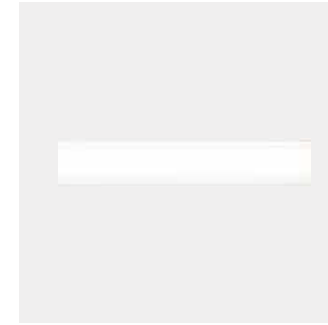

11914



11915

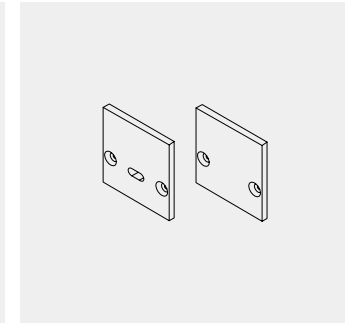

11916, 11917, 11918, 11924

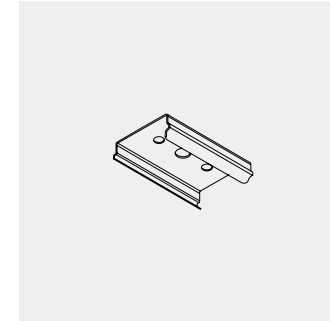

11919

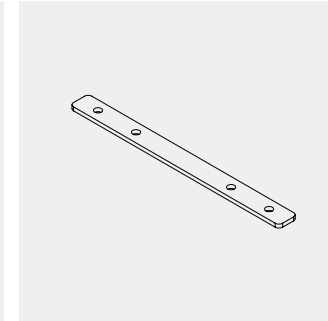

11920

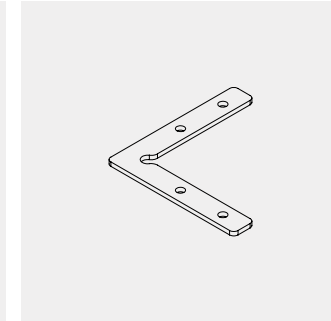

11921

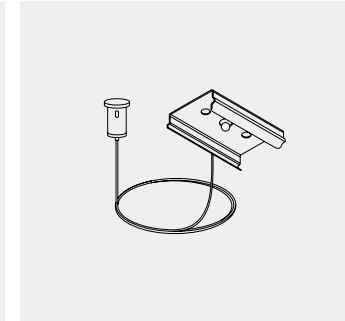

11922

CODE	FINISHING	DESCRIPTION	SIZE	PRICE
11914	Opale/Opal	Schermo / Diffuser	2mt	13,03
11915	Nero/Black	Schermo / Diffuser	2mt	13,03
11916	Alluminio/ Aluminium	Kit 4 viti + 2 testate di chiusura/4 screws + 2 end caps kit		8,12
11917	Bianco/White	Kit 4 viti + 2 testate di chiusura/4 screws + 2 end caps kit		8,12
11918	Nero/Black	Kit 4 viti + 2 testate di chiusura/4 screws + 2 end caps kit		8,12
11924	Oro/Gold	Kit 4 viti + 2 testate di chiusura/4 screws + 2 end caps kit		8,12
11919	n/a	Kit 2 staffe per soffitto/2 ceiling fixing brackets kit		3,00
11920	n/a	Congiunzione lineare/Linear junction		3,41
11921	n/a	Congiunzione 90°/90° junction		3,41
11922	n/a	Kit 2 sospensioni con cavo / 2 suspension kit with steel cable	3mt	16,29

## LINE DEEP INCASSO

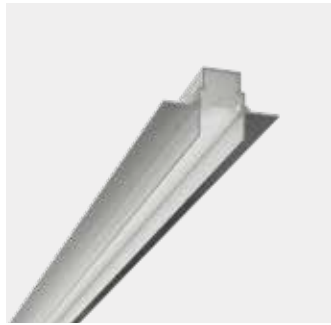

CODE	FINISHING	DESCRIPTION	SIZE	KG	PRICE
11910	Bianco/White	Profilo / Profile	2mt	1,30	32,09

### INSTALLAZIONE APPLICATION



Incasso/Recessed

### DISEGNI TECNICI TECHNICAL DRAWINGS

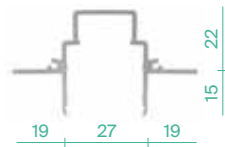

## ACCESSORI ACCESSORIES



21303



21304

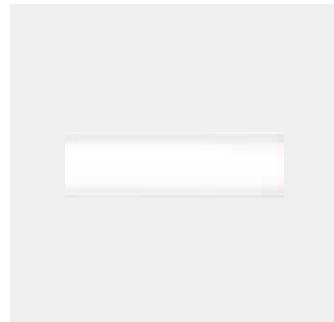

21305

CODE	FINISHING	DESCRIPTION	SIZE	PRICE
21303	Trasparente/ Transparent	Schermo / Diffuser	2mt	6,92
21304	Satinato/Frosted	Schermo / Diffuser	2mt	8,97
21305	Opale/Opal	Schermo / Diffuser	2mt	6,92

## LINE INCASSO



CODE	FINISHING	DESCRIPTION	SIZE	KG	PRICE
11906	Alluminio/Aluminium	Profilo / Profile	2mt	1,30	32,09

### INSTALLAZIONE APPLICATION

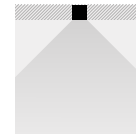

Incasso/Recessed

### DISEGNI TECNICI TECHNICAL DRAWINGS

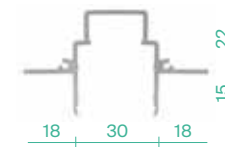

## ACCESSORI ACCESSORIES

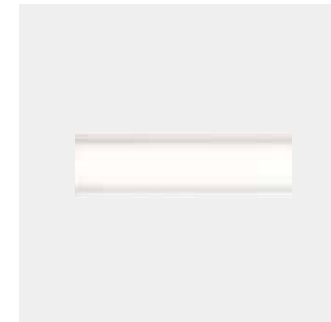

11675

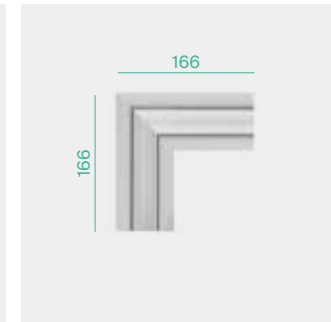

13570

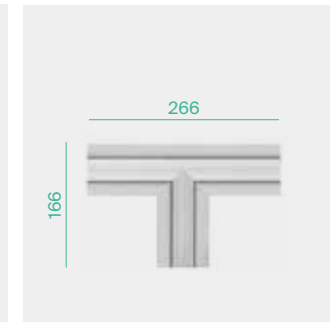

13571

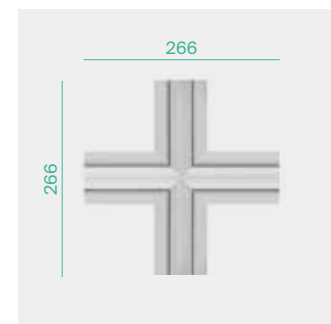

13572

CODE	FINISHING	DESCRIPTION	SIZE	PRICE
11675	Satinato-opale/ Opal-frosted	Schermo / Diffuser	2mt	21,06
13570	Alluminio/ Aluminium	Giunto "L"/L-Joint		35,70
13571	Alluminio/ Aluminium	Giunto "T"/T-Joint		44,12
13572	Alluminio/ Aluminium	Giunto "X"/X-Joint		51,74

## DOUBLE SOFFITTO



CODE	FINISHING	DESCRIPTION	SIZE	KG	PRICE
21472	Alluminio/Aluminium	Profilo / Profile	2mt	0,30	21,48
21473	Bianco/White	Profilo / Profile	2mt	0,30	24,34

### INSTALLAZIONE APPLICATION



Soffitto/Ceiling

### DISEGNI TECNICI TECHNICAL DRAWINGS

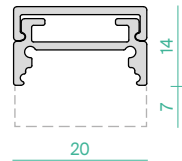

## ACCESSORI ACCESSORIES

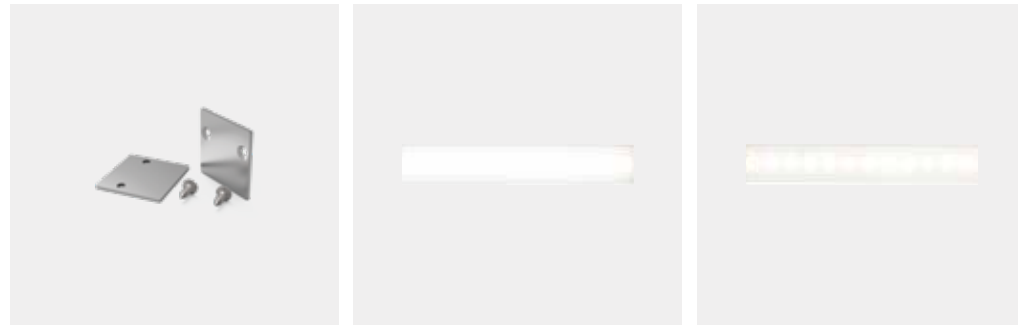

21476 - 21477

21474

21475

CODE	FINISHING	DESCRIPTION	SIZE	PRICE
21474	Opale/Opal	Schermo / Diffuser	2mt	6,83
21475	Satinato/Frosted	Schermo / Diffuser	2mt	9,42
21476	Alluminio/Aluminium	Kit 4 viti + 2 testate/ 4 screws + 2 end caps kit		0,95
21477	Bianco/White	Kit 4 viti + 2 testate/ 4 screws + 2 end caps kit		2,48

## PR1 SOFFITTO



CODE	FINISHING	DESCRIPTION	SIZE	KG	PRICE
21048	Alluminio/Aluminium	Profilo / Profile	2mt	0,20	10,84
21376	Bianco/White	Profilo / Profile	2mt	0,20	13,92

### INSTALLAZIONE APPLICATION



Soffitto/Ceiling

### DISEGNI TECNICI TECHNICAL DRAWINGS

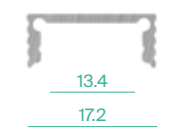

## PR1\_DEEP SOFFITTO



CODE	FINISHING	DESCRIPTION	SIZE	KG	PRICE
21494	Alluminio/Aluminium	Profilo / Profile	2mt	0,40	19,49
21495	Bianco/White	Profilo / Profile	2mt	0,40	22,95

### INSTALLAZIONE APPLICATION

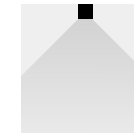

Soffitto/Ceiling

### DISEGNI TECNICI TECHNICAL DRAWINGS



## ACCESSORI ACCESSORIES



21052

21051

21301



21053 - 21378



21496 - 21497



21054 - 21379

CODE	FINISHING	DESCRIPTION	SIZE	PRICE
21052	Satinato/Frosted	Schermo per PR1, PR1_DEEP/ Diffuser for PR1, PR1_DEEP	2mt	7,91
21051	Trasparente/Transparent	Schermo per PR1, PR1_DEEP/ Diffuser for PR1, PR1_DEEP	2mt	5,95
21301	Opale/Opal	Schermo per PR1, PR1_DEEP/ Diffuser for PR1, PR1_DEEP	2mt	5,95
21053	Alluminio/Aluminium	Kit 4 viti + 2 testate per PR1 / 4 screws + 2 end caps kit for PR1		0,84
21378	Bianco/White	Kit 4 viti + 2 testate per PR1 / 4 screws + 2 end caps kit for PR1		2,42
21496	Alluminio/Aluminium	Kit 4 viti + 2 testate per PR1_DEEP / 4 screws + 2 end caps kit for PR1_DEEP		2,49
21497	Bianco/White	Kit 4 viti + 2 testate per PR1_DEEP / 4 screws + 2 end caps kit for PR1_DEEP		3,39
21054	Alluminio/Aluminium	Kit 2 staffe fissaggio per PR1, PR1_DEEP/ 2 fixing brackets kit for PR1, PR1_DEEP		0,57
21379	Bianco/White	Kit 2 staffe fissaggio per PR1, PR1_DEEP/ 2 fixing brackets kit for PR1, PR1_DEEP		2,04

## PR2 INCASSO



## PR2\_DEEP INCASSO



CODE	FINISHING	DESCRIPTION	SIZE	KG	PRICE
21049	Alluminio/Aluminium	Profilo / Profile	2mt	0,22	11,82
21377	Bianco/White	Profilo / Profile	2mt	0,22	14,68

CODE	FINISHING	DESCRIPTION	SIZE	KG	PRICE
21498	Alluminio/Aluminium	Profilo / Profile	2mt	0,44	29,42
21499	Bianco/White	Profilo / Profile	2mt	0,44	33,04

### INSTALLAZIONE APPLICATION

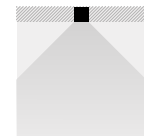

Incasso/Recessed

### DISEGNI TECNICI TECHNICAL DRAWINGS

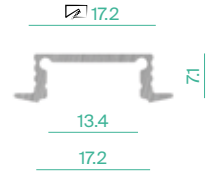

### INSTALLAZIONE APPLICATION

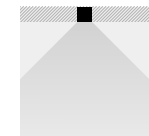

Incasso/Recessed

### DISEGNI TECNICI TECHNICAL DRAWINGS

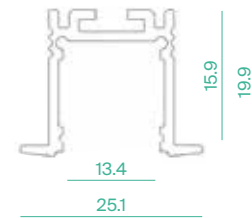

## ACCESSORI ACCESSORIES



21052



21051



21301



21053 - 21378



21496 - 21497



21054 - 21379



21500

CODE	FINISHING	DESCRIPTION	SIZE	PRICE
21052	Satinato/Frosted	Schermo per PR2, PR2_DEEP/ Diffuser for PR2, PR2_DEEP	2mt	7,91
21051	Trasparente/Transparent	Schermo per PR2, PR2_DEEP/ Diffuser for PR2, PR2_DEEP	2mt	5,95
21301	Opale/Opal	Schermo per PR2, PR2_DEEP/ Diffuser for PR2, PR2_DEEP	2mt	5,95
21053	Alluminio/Aluminium	Kit 4 viti + 2 testate per PR2/ 4 screws + 2 end caps kit for PR2		0,84
21378	Bianco/White	Kit 4 viti + 2 testate per PR2/ 4 screws + 2 end caps kit for PR2		2,42
21496	Alluminio/Aluminium	Kit 4 viti + 2 testate per PR2_DEEP/ 4 screws + 2 end caps kit for PR2_DEEP		2,49
21497	Bianco/White	Kit 4 viti + 2 testate per PR2_DEEP/ 4 screws + 2 end caps kit for PR2_DEEP		3,39
21054	Alluminio/Aluminium	Kit 2 staffe fissaggio per PR2, PR2_DEEP/ 2 fixing brackets kit for PR2, PR2_DEEP		0,57
21379	Bianco/White	Kit 2 staffe fissaggio per PR2, PR2_DEEP/ 2 fixing brackets kit for PR2, PR2_DEEP		2,04
21500	n/a	Molla per PR2_DEEP 2pz/Spring for PR2_DEEP 2pcs		5,50

## PR3\_EVO ANGOLO

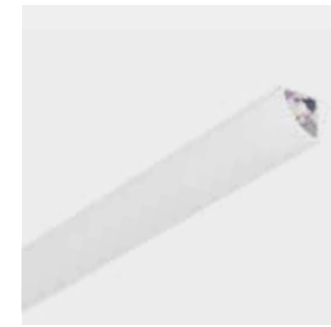

CODE	FINISHING	DESCRIPTION	SIZE	KG	PRICE
21440	Alluminio/Aluminium	Profilo / Profile	2mt	0,30	16,18
21441	Bianco/White	Profilo / Profile	2mt	0,30	18,22

### INSTALLAZIONE APPLICATION



Angolo/Corner

### DISEGNI TECNICI TECHNICAL DRAWINGS

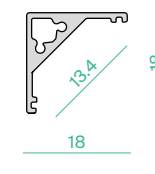

## ACCESSORI ACCESSORIES

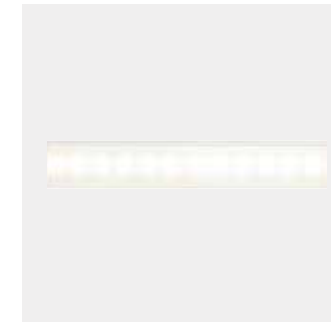

21442



21443

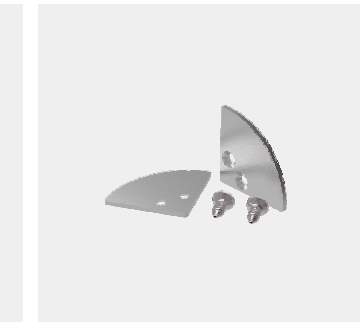

21444 - 21445



21446 - 21447

CODE	FINISHING	DESCRIPTION	SIZE	PRICE
21442	Satinato/Frosted	Schermo / Diffuser	2mt	8,87
21443	Opale/Opal	Schermo / Diffuser	2mt	6,41
21444	Alluminio/Aluminium	Kit 4 viti + 2 testate per PR3 EVO/4 screws + 2 end caps kit for PR3 EVO		0,98
21445	Bianco/White	Kit 4 viti + 2 testate per PR3 EVO/4 screws + 2 end caps kit for PR3 EVO		2,79
21446	Alluminio/Aluminium	Kit 2 staffe fissaggio per PR3 EVO/2 fixing brackets kit for PR3 EVO		1,06
21447	Bianco/White	Kit 2 staffe fissaggio per PR3 EVO/2 fixing brackets kit for PR3 EVO		2,26

## TWIGGY\_LESS



LED  
CRI >80

Ricarica con base di appoggio wireless con alimentatore (compreso)  
Charging through wireless base with charger (included)

CODE	FINISHING	WATT	LUMEN	WATT LIGHT SOURCE	LUMEN LIGHT SOURCE	BEAM	KELVIN	KG	PRICE
42753	Antracite/Anthracite	2.2W	150	1.8W	217	100°	2700/3000K	0,85	100,29
42754	Bianco/White	2.2W	150	1.8W	217	100°	2700/3000K	0,85	100,29
42755	Nero/Black	2.2W	150	1.8W	217	100°	2700/3000K	0,85	100,29
42756	Corten	2.2W	150	1.8W	217	100°	2700/3000K	0,85	100,29
42757	Giallo/Yellow	2.2W	150	1.8W	217	100°	2700/3000K	0,85	100,29
42758	Arancione/Orange	2.2W	150	1.8W	217	100°	2700/3000K	0,85	100,29
42759	Verde Salvia/Sage Green	2.2W	150	1.8W	217	100°	2700/3000K	0,85	100,29
42760	Blu Avio	2.2W	150	1.8W	217	100°	2700/3000K	0,85	100,29
42761	Sabbia/Sand	2.2W	150	1.8W	217	100°	2700/3000K	0,85	100,29
42820	Rosso Rubino/Ruby Red	2.2W	150	1.8W	217	100°	2700/3000K	0,85	100,29

### INSTALLAZIONE APPLICATION

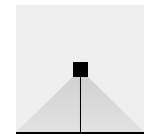

Appoggio/Standing

### DISEGNI TECNICI TECHNICAL DRAWINGS

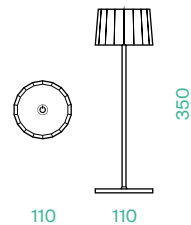

La garanzia fornita dalla casa sulla batteria è di 12 mesi  
/Manufacturer's warranty on battery is 12 months

## ACCESSORI ACCESSORIES

CODE	DESCRIPTION	Alimentazione/AC-DC Adaptor	PRICE
11654	Base ricarica multipla x6 lampade Multiple charger x6 lamps	100-240V 50/60Hz 9VDC 5A 45W	153,37

### DISEGNI TECNICI TECHNICAL DRAWINGS

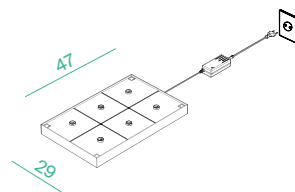

### Base per ricarica multipla

Questo sistema permette la ricarica multipla di 6 lampade (TWIGGY\_LESS and ZEN) nello stesso momento. Grazie ai quattro supporti è possibile sovrapporre fino a tre basi per un massimo di 18 lampade in carica contemporaneamente.

### Multiple induction charging base

*This system allows the multiple charging of 6 lamps (TWIGGY\_LESS - ZEN) at the same time. Thanks to the four supports, it's also possible to have up to three shelves being recharged so that a total of 18 lamps can be recharged at the same time.*



# DIOGENE



LED OSRAM  
CRI >80

Ricarica con cavo USB-C con alimentatore (compreso)  
Charging through USB-C cable with charger (included)

CODE	FINISHING	WATT	LUMEN	WATT LIGHT SOURCE	LUMEN LIGHT SOURCE	BEAM	KELVIN	KG	PRICE
42720	Antracite/Anthracite	2.2W	200	1.8W	205	120°	2700/3000K	1,60	116,80
42721	Bianco/White	2.2W	200	1.8W	205	120°	2700/3000K	1,60	116,80
42722	Nero/Black	2.2W	200	1.8W	205	120°	2700/3000K	1,60	116,80
42723	Corten	2.2W	200	1.8W	205	120°	2700/3000K	1,60	116,80
42762	Sabbia/Sand	2.2W	200	1.8W	205	120°	2700/3000K	1,60	116,80

## INSTALLAZIONE APPLICATION

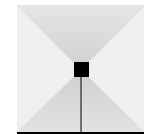

Appoggio/Standing

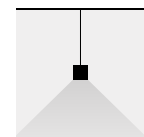

Sospesa/Hanging

## DISEGNI TECNICI TECHNICAL DRAWINGS

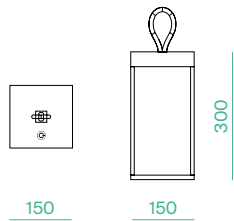

La garanzia fornita dalla casa sulla batteria è di 12 mesi /  
Manufacturer's warranty on battery is 12 months

# DIOGENE L



LED OSRAM  
CRI >80

Ricarica con cavo USB-C con alimentatore (compreso)  
Charging through USB-C cable with charger (included)

CODE	FINISHING	WATT	LUMEN	WATT LIGHT SOURCE	LUMEN LIGHT SOURCE	BEAM	KELVIN	KG	PRICE
42724	Antracite/Anthracite	2.2W	200	1.8W	205	120°	2700/3000K	1,80	127,42
42725	Bianco/White	2.2W	200	1.8W	205	120°	2700/3000K	1,80	127,42
42726	Nero/Black	2.2W	200	1.8W	205	120°	2700/3000K	1,80	127,42
42727	Corten	2.2W	200	1.8W	205	120°	2700/3000K	1,80	127,42
42763	Sabbia/Sand	2.2W	200	1.8W	205	120°	2700/3000K	1,80	127,42

## INSTALLAZIONE APPLICATION

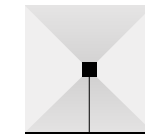

Appoggio/Standing

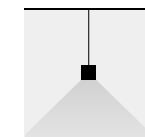

Sospesa/Hanging

## DISEGNI TECNICI TECHNICAL DRAWINGS

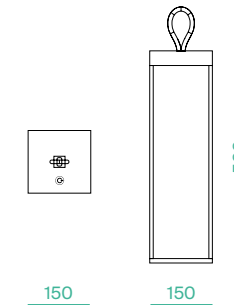

La garanzia fornita dalla casa sulla batteria è di 12 mesi /  
Manufacturer's warranty on battery is 12 months

# IOTA



LED OSRAM  
CRI >80

Ricarica con cavo USB-C con alimentatore (compreso) / Charging through USB-C cable with charger (included)

CODE	FINISHING	WATT	LUMEN	WATT LIGHT SOURCE	LUMEN LIGHT SOURCE	BEAM	KELVIN	KG	PRICE
42800	Antracite/ Dark Grey	2.5W	120	1.8W	200	120°	2700/3000K	0,75	103,95
42801	Bianco/ Matt White	2.5W	120	1.8W	200	120°	2700/3000K	0,75	103,95
42802	Nero/Matt Black	2.5W	120	1.8W	200	120°	2700/3000K	0,75	103,95
42803	Sabbia/Sand	2.5W	120	1.8W	200	120°	2700/3000K	0,75	103,95
42804	Rosso Rubino/ Ruby Red	2.5W	120	1.8W	200	120°	2700/3000K	0,75	103,95
42805	Verde Salvia/ Sage Green	2.5W	120	1.8W	200	120°	2700/3000K	0,75	103,95
42806	Blu Oceano/ Ocean Blue	2.5W	120	1.8W	200	120°	2700/3000K	0,75	103,95
42807	Corten	2.5W	120	1.8W	200	120°	2700/3000K	0,75	103,95

## INSTALLAZIONE APPLICATION

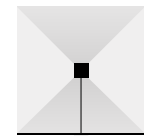

Appoggio/Standing

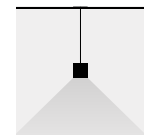

Sospesa/Hanging

## DISEGNI TECNICI TECHNICAL DRAWINGS

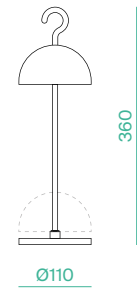

La garanzia fornita dalla casa sulla batteria è di 12 mesi /  
Manufacturer's warranty on battery is 12 months

# ZEN



LED OSRAM  
CRI >80

Ricarica con base di appoggio wireless con alimentatore (compreso) / Charging through wireless base with charger (included)

CODE	FINISHING	WATT	LUMEN	WATT LIGHT SOURCE	LUMEN LIGHT SOURCE	BEAM	KELVIN	KG	PRICE
42794	Bianco/ Matt White	2.5W	120	1.7W	206	120°	2700/3000K	0,55	114,95
42795	Sabbia/Sand	2.5W	120	1.7W	206	120°	2700/3000K	0,55	114,95
42796	Cromo/Chrome	2.5W	120	1.7W	206	120°	2700/3000K	0,55	171,15
42799	Grigio Siderale/ Space Grey	2.5W	120	1.7W	206	120°	2700/3000K	0,55	171,15

## INSTALLAZIONE APPLICATION

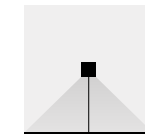

Appoggio/Standing

## DISEGNI TECNICI TECHNICAL DRAWINGS

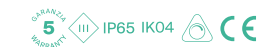
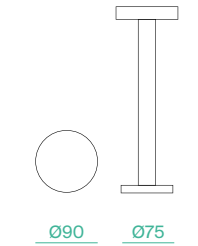

La garanzia fornita dalla casa sulla batteria è di 12 mesi /  
Manufacturer's warranty on battery is 12 months

## ACCESSORI ACCESSORIES

CODE	DESCRIPTION	Alimentazione/AC-DC Adaptor	PRICE
11654	Base ricarica multipla x6 lampade Multiple charger x6 lamps	100-240V 50/60Hz 9VDC 5A 45W	153,37

## DISEGNI TECNICI TECHNICAL DRAWINGS

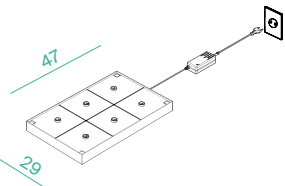



CODE	DESCRIPTION	PRICE
11371	Espositore lampade wireless / Display cabinet for wireless lamps	80,00

## SLICE PARETE



LED BRIDGELUX  
CRI >80  
PF >0.5

CODE	FINISHING	WATT	LUMEN	WATT LIGHT SOURCE	LUMEN LIGHT SOURCE	BEAM	KELVIN	KG	PRICE
41292	Bianco/White	3,5W+3,5W	263+263	2,9W+ 2,9W	360+360	90°	3000K	0,36	37,50
41293	Bianco/White	5W+5W	263+263	4,6W+ 4,6W	360+360	90°	3000K	0,51	44,50
41290	Nero/Black	3,5W+3,5W	343+343	2,9W+ 2,9W	360+360	90°	3000K	0,36	37,50
41291	Nero/Black	5W+5W	343+343	4,6W+ 4,6W	360+360	90°	3000K	0,51	44,50

INSTALLAZIONE  
APPLICATION



Parete/Wall

DISEGNI TECNICI  
TECHNICAL DRAWINGS

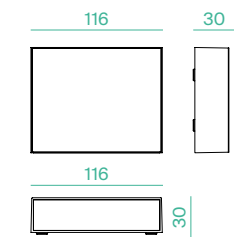

41292  
41290

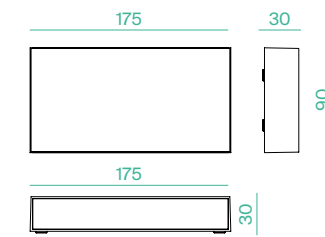

41293  
41291

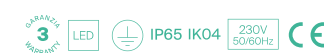

LOGICA

# TITANO EVO PARETE MONO-EMISSIONE



LED EDISON  
CRI >80  
PF 0.54 (6W)  
0.91 (10W)

CODE	FINISHING	WATT	LUMEN	WATT LIGHT SOURCE	LUMEN LIGHT SOURCE	BEAM	KELVIN	DRIVER	KG	PRICE
43126	Bianco/White	6W	300	4,6W	437	45°	3000K	500mA, 23V	0,85	78,76
43130	Antracite/ Anthracite	6W	300	4,6W	437	45°	3000K	500mA, 23V	0,85	78,76
43127	Bianco/White	6W	310	4,7W	448	45°	5000K	500mA, 23V	0,85	78,76
43131	Antracite/ Anthracite	6W	310	4,7W	448	45°	5000K	500mA, 23V	0,85	78,76
43128	Bianco/White	10W	700	9W	811	60°	3000K	250mA, 58V	1,4	101,77
43132	Antracite/ Anthracite	10W	700	9W	811	60°	3000K	250mA, 58V	1,4	101,77
43129	Bianco/White	10W	720	9,1W	834	60°	5000K	250mA, 58V	1,4	101,77
43133	Antracite/ Anthracite	10W	720	9,1W	834	60°	5000K	250mA, 58V	1,4	101,77

## INSTALLAZIONE APPLICATION



Parete/Wall

## DISEGNI TECNICI TECHNICAL DRAWINGS

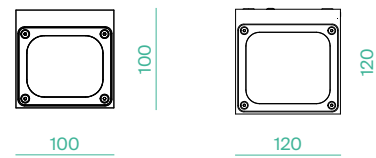

43126  
43127  
43130  
43131

43128  
43129  
43132  
43133

# TITANO EVO PARETE BI-EMISSIONE



LED EDISON  
CRI >80  
PF 0.57 (2X6W)  
0.92 (2X10W)

CODE	FINISHING	WATT	LUMEN	WATT LIGHT SOURCE	LUMEN LIGHT SOURCE	BEAM	KELVIN	DRIVER	KG	PRICE
43134	Bianco / White	6W+6W	300+ 300	4,6W+ 4,6W	437+437	45°	3000K	500mA, 24V 30V	0,93	89,38
43138	Antracite / Anthracite	6W+6W	300+ 300	4,6W+ 4,6W	437+437	45°	3000K	500mA, 24V 30V	0,93	89,38
43135	Bianco / White	6W+6W	310+ 310	4,7W+ 4,7W	448+448	45°	5000K	500mA, 24V 30V	0,93	89,38
43139	Antracite / Anthracite	6W+6W	310+ 310	4,7W+ 4,7W	448+448	45°	5000K	500mA, 24V 30V	0,93	89,38
43136	Bianco / White	10W+10W	700+ 700	9W+9W	811+811	60°	3000K	250mA, 98V	1,6	119,46
43140	Antracite / Anthracite	10W+10W	700+ 700	9W+9W	811+811	60°	3000K	250mA, 98V	1,6	119,46
43137	Bianco/ White	10W+10W	720+ 720	9,1W+9,1W	834+834	60°	5000K	250mA, 98V	1,6	119,46
43143	Antracite/ Anthracite	10W+10W	720+ 720	9,1W+9,1W	834+834	60°	5000K	250mA, 98V	1,6	119,46

## INSTALLAZIONE APPLICATION



Parete/Wall

## DISEGNI TECNICI TECHNICAL DRAWINGS

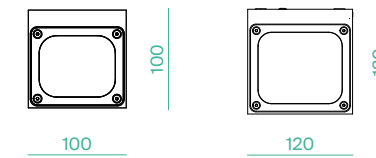

43134  
43135  
43138  
43139

43136  
43137  
43140  
43143

## TITANO EVO PALO



Corpo luminoso non incluso  
Lighting source not included

CODE	FINISHING	DESCRIPTION	SIZE	KG	PRICE
40580	Antracite/ Anthracite	Accessorio c/griglie antiabbagliamento/ Accessory with anti-glaring grid	120x120x580	2,20	100,29
40579	Antracite/ Anthracite	Accessorio c/griglie antiabbagliamento/ Accessory with anti-glaring grid	100x100x500	1,40	76,68

### INSTALLAZIONE APPLICATION



Terra/Floor

### DISEGNI TECNICI TECHNICAL DRAWINGS

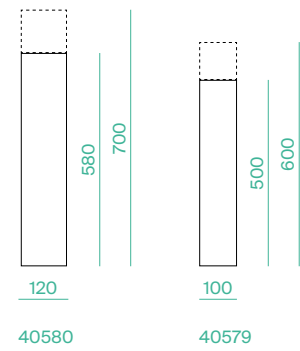

## TITANO EVO SOFFITTO



LED EDISON  
CRI >80  
PF 0.54 (6W)  
0.91 (10W)

CODE	FINISHING	WATT	LUMEN	WATT LIGHT SOURCE	LUMEN LIGHT SOURCE	BEAM	KELVIN	DRIVER	KG	PRICE
43144	Bianco/ White	6W	300	4,6W	437	45°	3000K	500mA, 23V	0,85	78,76
43148	Antracite/ Anthracite	6W	300	4,6W	437	45°	3000K	500mA, 23V	0,85	78,76
43145	Bianco/ White	6W	310	4,7W	448	45°	5000K	500mA, 23V	0,85	78,76
43149	Antracite/ Anthracite	6W	310	4,7W	448	45°	5000K	500mA, 23V	0,85	78,76
43146	Bianco/ White	10W	700	9W	811	60°	3000K	250mA, 58V	1,40	101,77
43150	Antracite/ Anthracite	10W	700	9W	811	60°	3000K	250mA, 58V	1,40	101,77
43147	Bianco/ White	10W	720	9,1W	834	60°	5000K	250mA, 58V	1,40	101,77
43151	Antracite/ Anthracite	10W	720	9,1W	834	60°	5000K	250mA, 58V	1,40	101,77

### INSTALLAZIONE APPLICATION



Soffitto/Ceiling

### DISEGNI TECNICI TECHNICAL DRAWINGS

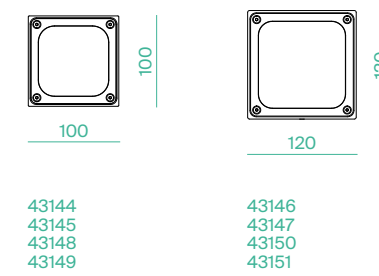

3 YEAR WARRANTY LED IP54 IK08 230V 50/60Hz CE

## MOONLIGHT PALO



LED RF2835  
CRI 80  
PF 0.9

CODE	FINISHING	WATT	LUMEN	WATT LIGHT SOURCE	LUMEN LIGHT SOURCE	BEAM	KELVIN	DRIVER	KG	PRICE
41167	Antracite/ Anthracite	10W	700	9,5W	1200	90°	3000K	250VDC/ 32mA	1,30	70,79
41168	Antracite/ Anthracite	15W	1050	14,5W	1650	90°	3000K	250VDC/ 48mA	1,60	100,29
41169	Antracite/ Anthracite	20W	1400	19,5W	2120	100°	3000K	250VDC/ 64mA	2,00	163,99

### INSTALLAZIONE APPLICATION



Terra/Floor

### DISEGNI TECNICI TECHNICAL DRAWINGS

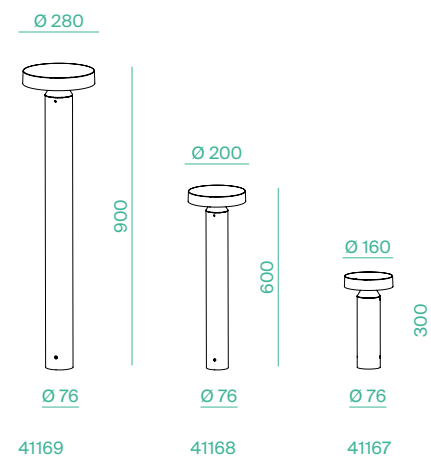

## MOONLIGHT PARETE



LED RF2835  
CRI 80  
PF 0.9

CODE	FINISHING	WATT	LUMEN	WATT LIGHT SOURCE	LUMEN LIGHT SOURCE	BEAM	KELVIN	DRIVER	KG	PRICE
41166	Antracite/ Anthracite	15W	1050	14,5W	1650	90°	3000K	250VDC/48mA	0,90	73,14

### INSTALLAZIONE APPLICATION



Parete/Wall

### DISEGNI TECNICI TECHNICAL DRAWINGS

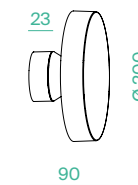

## ACCESSORI ACCESSORIES



CODE	FINISHING	DESCRIPTION	PRICE
11554	Antracite/ Anthracite	Distanziale per parete / Wall mounting spacer	11,33



# FOS PALO



LED RF2835  
CRI 80  
PF 0.9

CODE	FINISHING	WATT	LUMEN	WATT LIGHT SOURCE	LUMEN LIGHT SOURCE	BEAM	KELVIN	DRIVER	KG	PRICE
41165	Antracite/ Anthracite	8W	650	6,4W	860	120°	3000K	250VDC/48mA	1,70	121,52

## INSTALLAZIONE APPLICATION



Terra/Floor

## DISEGNI TECNICI TECHNICAL DRAWINGS

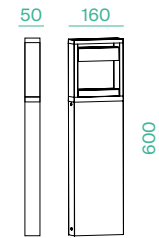

## REGOLAZIONI ADJUSTABILITY



# COMBI\_EVO



LED BRIDGELUX  
CRI >80  
PF >0.5

CODE	FINISHING	WATT	LUMEN	WATT LIGHT SOURCE	LUMEN LIGHT SOURCE	BEAM	KELVIN	DRIVER	KG	PRICE
43168	Bianco/White	5W+5W	445+445	4,5W+4,5W	563+563	0-90°	3000K	300mA 100-240V	0,64	84,95
43169	Nero/Black	5W+5W	445+445	4,5W+4,5W	563+563	0-90°	3000K	300mA 100-240V	0,64	84,95

## INSTALLAZIONE APPLICATION



Parete/Wall

## DISEGNI TECNICI TECHNICAL DRAWINGS

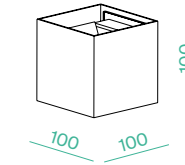

## REGOLAZIONI ADJUSTABILITY



# FOS PARETE



LED RF2835  
CRI 80  
PF 0.9

CODE	FINISHING	WATT	LUMEN	WATT LIGHT SOURCE	LUMEN LIGHT SOURCE	BEAM	KELVIN	DRIVER	KG	PRICE
41164	Antracite/ Anthracite	8W	650	6,4W	860	120°	3000K	250VDC/48mA	1,10	75,51

## INSTALLAZIONE APPLICATION



Parete/Wall

## DISEGNI TECNICI TECHNICAL DRAWINGS

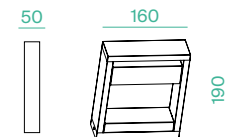

## REGOLAZIONI ADJUSTABILITY

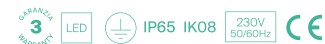

## DARDO



CODE	FINISHING	WATT	LUMEN	WATT LIGHT SOURCE	LUMEN LIGHT SOURCE	BEAM	KELVIN	KG	PRICE
42790	Antracite/ Anthracite	6W	320	4,2W	397	30°	3000K	1,20	98,28

### INSTALLAZIONE APPLICATION

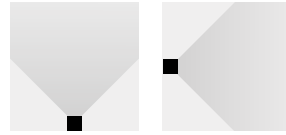

Terra/Floor

Parete/Wall

### DISEGNI TECNICI TECHNICAL DRAWINGS

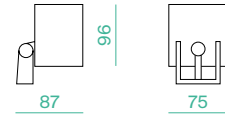

87

96

75

### REGOLAZIONI ADJUSTABILITY



90°



## ACCESSORI ACCESSORIES



42791



42792

CODE	DESCRIPTION	PRICE
42791	Accessorio anti-glare/Anti-glare accessory	10,62
42792	Accessorio picchetto in plastica/Plastic spike accessory	7,57

## SKORPIO S

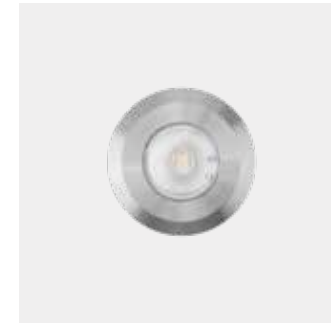

LED COB EDISON  
CRI >80  
PF 0.5

CODE	FINISHING	WATT	LUMEN	WATT LIGHT SOURCE	LUMEN LIGHT SOURCE	BEAM	KELVIN	KG	PRICE
40248	Inox	4,5W	265	3,2W	332	35°	3000K	0,70	82,45
40249	Inox	4,5W	275	3,1W	359	35°	5000K	0,70	82,45

### INSTALLAZIONE APPLICATION



Calpestabile/  
Walk-Over

### DISEGNI TECNICI TECHNICAL DRAWINGS

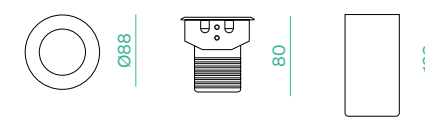

Ø88

80

120

Ø80  
Framework





# SKORPIO L



LED COB EDISON  
CRI >80  
PF 0.5

CODE	FINISHING	WATT	LUMEN	WATT LIGHT SOURCE	LUMEN LIGHT SOURCE	BEAM	KELVIN	KG	PRICE
40250	Inox	10W	600	9W	806	35°	3000K	1,42	133,98
40251	Inox	10W	615	9,1W	824	35°	5000K	1,42	133,98

## INSTALLAZIONE APPLICATION



Calpestabile/  
Walk-Over

## DISEGNI TECNICI TECHNICAL DRAWINGS

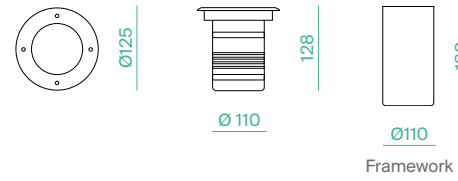

# SKORPIO ACCESSORI ACCESSORIES



40015



40016

CODE	DESCRIPTION	PRICE
40015	Connettore IP67 1 via / IP67 connector_one exit	8,47
40016	Connettore IP67 2 vie / IP67 connector_two exits	13,87

# GRUPPO EMERGENZA EMERGENCY UNIT

CODE	EFFICIENCY	WATT	KG	PRICE
12551	30% - 90MIN.	MAX 40W	0,10	61,51

## DISEGNI TECNICI TECHNICAL DRAWINGS

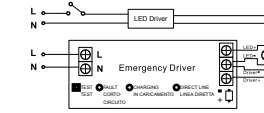
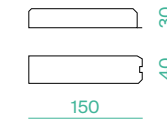

# DRIVER



CODE	VOLTAGE	CURRENT	MODEL	SIZE	MODE	PRICE
42683	220-240 12-42V	650-1100mA	ONE4ALL	125x76x30mm	DALI, PUSH, 1-10V	56,63
42684	220-240 12-42V	250-600mA	ONE4ALL	125x76x30mm	DALI, PUSH, 1-10V	54,27
40314	110-277V 14-42V	400-1100mA	n/a	115x52x30mm	1-10V	49,09

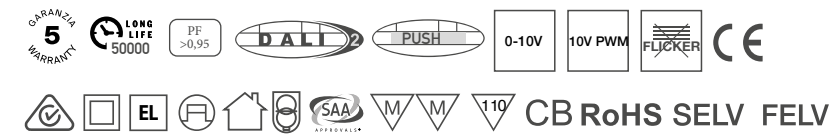

## Listino Prezzi

## Price List

CODE	PRICE	PAGE	CODE	PRICE	PAGE	CODE	PRICE	PAGE	CODE	PRICE	PAGE	CODE	PRICE	PAGE
11044	213,12	19-27-33	21379	2,04	115-116	40016	13,87	136	41117	163,99	14	41192	90,85	10
11045	292,62	19-27-33	21385	59,18	109	40248	82,45	135	41118	234,78	14	41193	93,20	14
11371	80,00	124	21386	4,41	109	40249	82,45	135	41119	47,19	12	41194	163,99	14
11554	11,33	131	21387	5,06	109	40250	133,98	136	41120	66,07	12	41195	234,78	14
11620	20,28	47	21388	58,46	108	40251	133,98	136	41121	116,80	12	41196	93,20	14
11621	20,28	47	21389	4,67	108	40314	49,09	137	41122	47,19	12	41197	163,99	14
11654	153,37	118-123	21440	16,18	117	40579	76,68	128	41123	66,07	12	41198	234,78	14
11675	21,06	113	21441	18,22	117	40580	100,29	128	41124	116,80	12	41199	47,19	12
11906	32,09	113	21442	8,87	117	40615	74,74	106	41125	116,80	13	41200	66,07	12
11910	32,09	112	21443	6,41	117	40617	74,74	106	41126	152,19	13	41201	116,80	12
11911	29,09	110	21444	0,98	117	40619	21,06	80	41127	234,78	13	41202	47,19	12
11912	29,09	110	21445	2,79	117	40624	35,50	80	41128	116,80	13	41203	66,07	12
11913	29,09	110	21446	1,06	117	40754	67,13	41	41129	152,19	13	41204	116,80	12
11914	13,03	111	21447	2,26	117	40755	67,13	41	41130	234,78	13	41205	116,80	13
11915	13,03	111	21472	21,48	114	40758	50,14	41	41131	12,98	19	41206	152,19	13
11916	8,12	111	21473	24,34	114	40759	50,14	41	41132	12,39	19-27	41207	234,78	13
11917	8,12	111	21474	6,83	114	40760	60,17	95	41132/A	12,39	19-27	41208	116,80	13
11918	8,12	111	21475	9,42	114	40761	60,17	95	41133/A	12,39	19-27	41209	152,19	13
11919	3,00	111	21476	0,95	114	40762	32,00	97	41134	4,71	19	41210	234,78	13
11920	3,41	111	21477	2,48	114	40763	32,00	97	41135	4,71	19	41211	105,00	15
11921	3,41	111	21494	19,49	115	41063	28,14	75	41136	51,91	18	41212	105,00	15
11922	16,29	111	21495	22,95	115	41064	28,14	75	41137	51,91	18	41213	96,75	10
11923	29,09	110	21496	2,49	115-116	41065	30,26	75	41138	51,91	18	41214	96,75	10
11924	8,12	111	21497	3,39	115-116	41066	30,26	75	41139	51,91	18	41215	128,59	10
12551	61,51	137	21498	29,42	116	41094	194,66	44	41140	51,91	18	41216	128,59	10
12556	17,58	75-79	21499	33,04	116	41095	194,66	44	41141	51,91	18	41217	149,14	19-27-33
12557	11,68	75-79	21500	5,50	116	41096	194,66	44	41142	8,26	19	41218	164,72	19-27-33
13570	35,70	113	21721	34,65	68	41097	194,66	44	41143	8,26	19	41219	208,13	19-27-33
13571	44,12	113	21722	34,65	68	41098	194,66	44	41144	210,00	18	41222	8,14	19
13572	51,74	113	21723	46,75	69	41099	194,66	44	41145	210,00	18	41223	8,14	19
21048	10,84	115	21724	46,75	69	41100	194,66	44	41146	6,49	18	41240	19,47	19
21049	11,82	116	21725	46,75	69	41101	194,66	44	41164	75,51	132	41241	19,47	19
21051	5,95	115-116	21726	46,75	69	41102	194,66	44	41165	121,52	132	41257	57,81	19
21052	7,91	115-116	21727	46,75	69	41103	194,66	44	41166	73,14	131	41258	57,81	19
21053	0,84	115-116	21728	46,75	69	41104	194,66	44	41167	70,79	130	41259	57,81	19
21054	0,57	115-116	22015	34,45	19-27-33	41105	194,66	44	41168	100,29	130	41260	57,81	19
21301	5,95	108-115-116	22016	61,74	19-27-33	41109	105,00	18	41169	163,99	130	41281	13,30	68
21303	6,92	112	22017	132,30	19-27-33	41110	105,00	18	41173	105,00	15	41282	13,30	68
21304	8,97	112	22025	65,05	19-27-33	41111	90,85	10	41174	105,00	15	41283	15,25	69
21305	6,92	112	22031	39,69	19-27-33	41112	90,85	10	41175	96,75	10	41284	15,25	69
21376	13,92	115	22032	50,72	19-27-33	41113	93,20	14	41176	96,75	10	41285	19,60	70
21377	14,68	116	22033	65,05	19-27-33	41114	163,99	14	41177	128,59	10	41286	19,60	70
21378	2,42	115-116	22034	83,79	19-27-33	41115	234,78	14	41178	128,59	10	41287	15,65	68
			40015	8,47	136	41116	93,20	14	41179	90,85	10	41288	19,40	69

CODE	PRICE	PAGE	CODE	PRICE	PAGE	CODE	PRICE	PAGE	CODE	PRICE	PAGE	CODE	PRICE	PAGE
41289	29,50	70	41721	142,80	21	41773	135,45	10	41829	151,00	37	41878	64,62	93
41290	37,50	125	41722	142,80	21	41774	90,30	15	41830	151,00	37	41879	64,62	93
41291	44,50	125	41723	65,10	23	41775	90,30	15	41831	151,00	37	41880	64,62	93
41292	37,50	125	41724	65,10	23	41776	87,15	16	41832	151,00	37	41881	64,62	93
41293	44,50	125	41725	114,45	23	41777	87,15	16	41833	174,00	39	41882	64,62	93
41666	77,28	36	41726	114,45	23	41778	86,10	11	41834	174,00	39	41883	64,62	93
41667	77,28	36	41727	166,95	23	41779	86,10	11	41835	174,00	39	41884	64,62	93
41668	77,28	36	41728	166,95	23	41780	25,46	27	41836	136,00	35	41885	407,76	89
41669	77,28	36	41729	109,20	22	41781	25,46	27	41837	136,00	35	41886	551,15	89
41670	77,28	36	41730	109,20	22	41782	25,46	19	41838	136,00	35	41887	407,76	89
41671	77,28	36	41731	166,95	22	41783	25,46	19	41839	136,00	35	41888	551,15	89
41672	77,28	36	41732	166,95	22	41784	161,70	27	41840	151,00	37	41889	364,95	92
41673	77,28	36	41733	81,90	20	41785	216,30	27	41841	151,00	37	41890	514,27	92
41674	77,28	36	41734	81,90	20	41786	266,70	27	41842	151,00	37	41891	364,95	92
41675	77,28	36	41735	85,70	20	41788	161,70	27	41843	151,00	37	41892	514,27	92
41676	77,28	36	41736	85,70	20	41789	216,30	27	41844	174,00	39	41893	229,00	6
41677	77,28	36	41737	99,06	24	41790	266,70	27	41845	174,00	39	41894	229,00	6
41678	77,28	36	41738	99,06	24	41797	64,62	34	41846	174,00	39	41895	229,00	6
41679	77,28	36	41739	96,60	24	41798	64,62	34	41847	136,00	35	41896	229,00	6
41680	77,28	36	41740	96,60	24	41799	64,62	34	41848	136,00	35	41897	285,00	6
41681	77,28	36	41741	90,30	25	41800	64,62	34	41849	136,00	35	41898	285,00	6
41682	86,90	71	41742	90,30	25	41801	95,70	38	41850	136,00	35	41899	285,00	6
41683	86,90	71	41743	87,15	25	41802	95,70	38	41851	151,00	37	41900	285,00	6
41684	86,90	71	41744	87,15	25	41803	95,70	38	41852	151,00	37	41901	345,00	6
41685	86,90	71	41745	86,10	21	41804	64,62	34	41853	151,00	37	41902	345,00	6
41686	86,90	71	41746	86,10	21	41805	64,62	34	41854	151,00	37	41903	345,00	6
41687	86,90	71	41747	48,30	27	41806	64,62	34	41855	174,00	39	41904	345,00	6
41688	86,90	71	41748	48,30	27	41807	64,62	34	41856	174,00	39	41905	95,70	38
41689	86,90	71	41749	48,30	27	41808	95,70	38	41857	174,00	39	41906	95,70	38
41690	86,90	71	41750	48,30	27	41809	95,70	38	41858	136,00	35	41907	95,70	38
41691	86,90	71	41751	48,30	27	41810	95,70	38	41859	136,00	35	41908	95,70	38
41692	86,90	71	41752	48,30	27	41811	64,62	34	41860	136,00	35	41909	174,00	39
41693	86,90	71	41753	53,55	27	41812	64,62	34	41861	136,00	35	41910	174,00	39
41694	86,90	71	41754	53,55	27	41813	64,62	34	41862	151,00	37	41911	174,00	39
41695	86,90	71	41755	53,55	27	41814	64,62	34	41863	151,00	37	41912	174,00	39
41696	86,90	71	41756	53,55	27	41815	95,70	38	41864	151,00	37	41913	36,90	40
41697	86,90	71	41757	4,20	27	41816	95,70	38	41865	151,00	37	41914	36,90	40
41705	89,84	97	41758	4,20	27	41817	95,70	38	41866	174,00	39	41915	36,90	94
41706	89,84	97	41759	7,35	27-33	41818	64,62	34	41867	174,00	39	41916	36,90	94
41707	110,19	92	41760	7,35	27-33	41819</								



CODE	PRICE	PAGE	CODE	PRICE	PAGE	CODE	PRICE	PAGE
71832	53,57	53	71881	74,82	53	71930	109,97	55
71833	53,57	53	71882	92,47	55	71931	109,97	55
71834	68,20	55	71883	92,47	55	71932	109,97	55
71835	68,20	55	71884	92,47	55	71933	109,97	55
71836	68,20	55	71885	92,47	55	71934	109,97	55
71837	68,20	55	71886	92,47	55	71935	109,97	55
71838	68,20	55	71887	92,47	55	71936	109,97	55
71839	68,20	55	71888	92,47	55	71937	109,97	55
71840	68,20	55	71889	92,47	55			
71841	68,20	55	71890	77,55	50			
71842	53,80	50	71891	77,55	50			
71843	53,80	50	71892	77,55	50			
71844	53,80	50	71893	77,55	50			
71845	53,80	50	71894	77,55	50			
71846	53,80	50	71895	77,55	50			
71847	53,80	50	71896	77,55	50			
71848	53,80	50	71897	77,55	50			
71849	53,80	50	71898	87,15	52			
71850	69,15	52	71899	87,15	52			
71851	69,15	52	71900	87,15	52			
71852	69,15	52	71901	87,15	52			
71853	69,15	52	71902	87,15	52			
71854	69,15	52	71903	87,15	52			
71855	69,15	52	71904	87,15	52			
71856	69,15	52	71905	87,15	52			
71857	69,15	52	71906	103,75	54			
71858	86,25	54	71907	103,75	54			
71859	86,25	54	71908	103,75	54			
71860	86,25	54	71909	103,75	54			
71861	86,25	54	71910	103,75	54			
71862	86,25	54	71911	103,75	54			
71863	86,25	54	71912	103,75	54			
71864	86,25	54	71913	103,75	54			
71865	86,25	54	71914	82,49	51			
71866	58,74	51	71915	82,49	51			
71867	58,74	51	71916	82,49	51			
71868	58,74	51	71917	82,49	51			
71869	58,74	51	71918	82,49	51			
71870	58,74	51	71919	82,49	51			
71871	58,74	51	71920	82,49	51			
71872	58,74	51	71921	82,49	51			
71873	58,74	51	71922	92,82	53			
71874	74,82	53	71923	92,82	53			
71875	74,82	53	71924	92,82	53			
71876	74,82	53	71925	92,82	53			
71877	74,82	53	71926	92,82	53			
71878	74,82	53	71927	92,82	53			
71879	74,82	53	71928	92,82	53			
71880	74,82	53	71929	92,82	53			

## Indice alfabetico

### Alphabetical index

<b>A</b>	<b>92</b> A+B SOFFITTO	<b>I</b>	<b>122</b> IOTA	<b>T</b>	<b>126</b> TITANO_EVO
	<b>89</b> A+B SOSPENSIONE			<b>45</b> TRACKS	
	<b>98</b> ALTAIR	<b>K</b>	<b>10</b> KLIK_KLAK	<b>118</b> TWIGGY_LESS	
	<b>80</b> AQUA_EVO		<b>96</b> KLIK_KLAK PUNIFORME SOFFITTO	<b>U</b>	<b>41</b> UNICO TRACK
<b>B</b>	<b>72</b> BELLATRIX		<b>20</b> KLIK KLAK MINI	<b>95</b> UNICO DICRO SOFFITTO/PARETE	
	<b>106</b> BLOC_EVO		<b>28</b> KLIK KLAK MICRO		
	<b>100</b> BOX	<b>L</b>	<b>68</b> LIGHT_35	<b>W</b>	<b>108</b> WALL
<b>C</b>	<b>133</b> COMBI EVO		<b>69</b> LIGHT_50	<b>88</b> WIZARD	
	<b>101</b> CONTAINER		<b>70</b> LIGHT_111		
	<b>97</b> CYL SOFFITTO		<b>6</b> LINEAR	<b>Z</b>	<b>123</b> ZEN
	<b>92</b> CYL SOSP		<b>112</b> LINE DEEP	<b>79</b> ZEUS	
			<b>113</b> LINE		
<b>D</b>	<b>134</b> DARDO		<b>110</b> LINE_EVO		
	<b>56</b> DEEP_EVO	<b>M</b>	<b>76</b> MINI		
	<b>50</b> DEEP_EVO EXTR.		<b>104</b> MINIMA		
	<b>60</b> DEEP_EVO GRANDE		<b>66</b> MODULI LED DEEP_EVO		
	<b>62</b> DEEP_EVO_Q		<b>130</b> MOONLIGHT		
	<b>63</b> DEEP_EVO_Q GRANDE	<b>O</b>	<b>75</b> OCCHIO		
	<b>64</b> DEEP_EVO STD		<b>109</b> ONDA		
	<b>120</b> DIOGENE	<b>P</b>	<b>115</b> PR1		
	<b>114</b> DOUBLE		<b>115</b> PR1_DEEP		
	<b>137</b> DRIVER E ACCESSORI		<b>116</b> PR2		
	<b>107</b> DUMBO		<b>116</b> PR2_DEEP		
<b>E</b>	<b>49</b> EMERGENZA TRACK		<b>117</b> PR3_EVO		
	<b>105</b> ESSENTIAL		<b>73</b> PUNTO		
<b>F</b>	<b>132</b> FOS	<b>S</b>	<b>135</b> SKORPIO		
	<b>82</b> FRAME		<b>90</b> SHANGHAI		
	<b>83</b> FRAME 111		<b>125</b> SLICE		
	<b>85</b> FRAMELESS		<b>42</b> SOSPENSIONI TRACK		
	<b>86</b> FRAMELESS 111		<b>44</b> STREAMLIGHT TRACK		
	<b>34</b> FULGOR TRACK		<b>9</b> STREAMLIGHT INCASSO		
	<b>71</b> FULGOR_IN		<b>7</b> STREAMLIGHT SYSTEM		
	<b>93</b> FULGOR SOFFITTO/PARETE		<b>106</b> SU&GIÙ		
			<b>40</b> SUN_111 TRACK		
			<b>94</b> SUN_111 SOFFITTO/PARETE		

---

# Logica è un marchio di Marino Cristal S.p.A.

---

**Marino Cristal S.p.A.**

Via Guardia del Consiglio, 31  
47899 Serravalle  
Rep. di San Marino

Tel. (+378) 0549 901188  
Fax (+378) 0549 900612

[www.logicailuminazione.com](http://www.logicailuminazione.com)  
[info@logicailuminazione.com](mailto:info@logicailuminazione.com)

Progetto grafico  
*Studio JAM*

Stampa  
*Gruppo Leardini*