

LIGHT & BEYOND

2023

Oltre alla luce

Beyond light

Illuminare un ambiente premendo un interruttore è un gesto semplice: un tocco immediato e la stanza prende forma, mostrandosi nell'esperienza quotidiana. Dietro a questa azione si nasconde il lavoro illuminotecnico, fatto di progetti e visioni, che permette di sfruttare le peculiarità di apparecchi e spazi, combinandoli tra loro affinché diano la migliore resa possibile. Per questo lavoriamo continuamente per integrare nuovi elementi alla nostra offerta e migliorare quelli già presenti, permettendoci di offrire la soluzione migliore per ogni necessità. Funzionalità e versatilità sono i punti fondamentali di ogni apparecchio LOGICA, unitamente a un design minimale e una illuminazione di qualità.

Lighting an area turning the light on is a simple operation: a quick touch and the room shapes up, shows itself in its daily experience. Behind this action though, it's hidden the lighting designer's work, made of projects and visions which make sure that all peculiarities of fittings and spaces are combined so that the best and most rewarding solution is achieved. This is why we continuously work to add new items to our ranges and improve the existing ones in order to offer the best solution for each single requirement. Functionality and versatility are the two fundamental principles behind each single LOGICA product together with minimalistic design and light quality

A+B è la soluzione di illuminazione di design perfetta per creare un'atmosfera sofisticata e accogliente nei tuoi ambienti. Con il suo corpo minimale e la sua illuminazione diffusa sia diretta che indiretta, questo prodotto è ideale per arredare con stile ambienti casalinghi e showroom. Disponibile sia in versione a sospensione che a soffitto, A+B si adatta a ogni esigenza di illuminazione e arredamento, creando un'atmosfera unica ed elegante.

A+B is the perfect design lighting solution to create a sophisticated and comfortable atmosphere in your living spaces. Thanks to its minimalistic body in cylindrical shape and its direct and indirect lighting option, this product is an ideal lighting solution both in residential and showroom application. It's available in both suspension and ceiling version and no matter what you choose, it always ensures an elegant and unique atmosphere.



A+B Suspension & Ceiling



A+B Suspension & Ceiling

Esperienza visiva confortevole

Comfortable visual experience

L'uso di prodotti illuminotecnici progettati con attenzione al benessere visivo può fare la differenza tra uno spazio confortevole e uno che causa disturbo e affaticamento. A+B integra uno schermo prismatico il quale, unitamente all'emissione secondaria di luce indiretta, garantisce un'esperienza visiva piacevole e sana, grazie a un grado di UGR<16. Una corretta illuminazione può migliorare la qualità della vita, la produttività e la sicurezza, garantendo una fruizione degli spazi senza disagio o difficoltà, garantendo un'esperienza visiva piacevole e sana.

The choice of proper lighting fittings purposely designed to provide visual comfort can make a big difference between a comfortable environment and one which causes eyestrain and tiredness. A+B combines a direct lighting microprismatic diffuser (UGR<16) with a secondary indirect light source which guarantee a healthy and comfortable visual experience. Proper lighting solutions improve life quality, increase productivity and safety ensuring a pleasant visual experience.

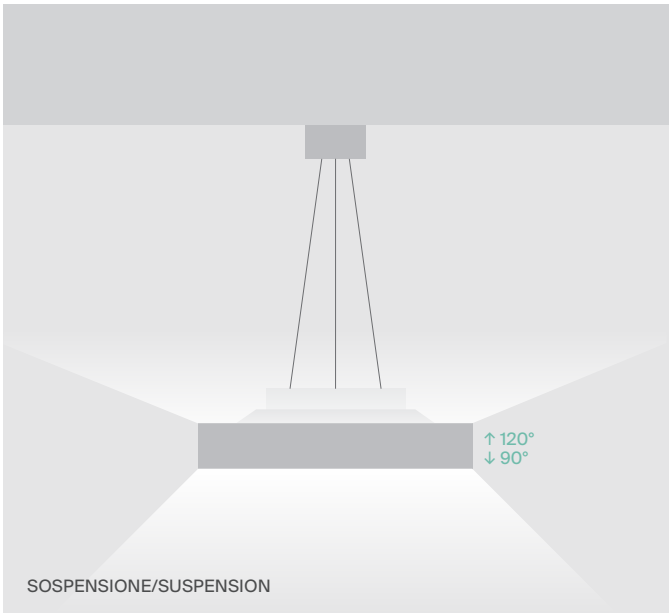
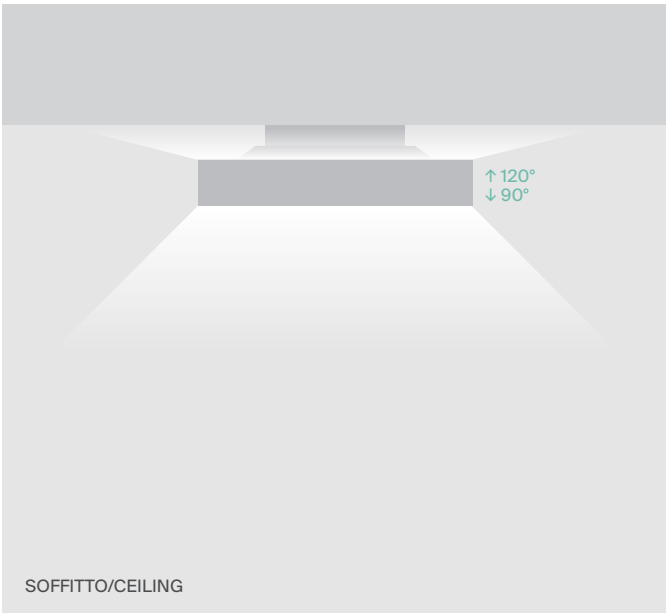



A+B SOSPENSIONE DALI-PUSH

LED
CRI >90
PF >0.9
SDCM <6
UGR <16

| CODE | FINISHING | WATT | LUMEN | WATT LIGHT SOURCE | LUMEN LIGHT SOURCE | BEAM | KELVIN | DRIVER |
|-------|--------------|---------------|-------------|-------------------|--------------------|----------|--------|--------------------------------------|
| 41885 | Bianco/White | ↓ 26W + ↑ 12W | 2412 + 1471 | 26W+11,6W | 3236+1501 | 90°+120° | 3000K | 38W 30-40V 1050mA |
| 41887 | Bianco/White | ↓ 26W + ↑ 12W | 2629 + 1603 | 26W+11,6W | 3603+1636 | 90°+120° | 4000K | 38W 30-40V 1050mA |
| 41886 | Bianco/White | ↓ 38W+ ↑ 20W | 3570 + 2317 | 36W+20W | 4109+2685 | 90°+120° | 3000K | 38W 30-40V 1050mA + 20W 30-40V 500mA |
| 41888 | Bianco/White | ↓ 38W+ ↑ 20W | 3892 + 2525 | 36W+20W | 4782+2926 | 90°+120° | 4000K | 38W 30-40V 1050mA + 20W 30-40V 500mA |

INSTALLAZIONE APPLICATION



Sospensione/
Suspension

DISEGNI TECNICI TECHNICAL DRAWINGS

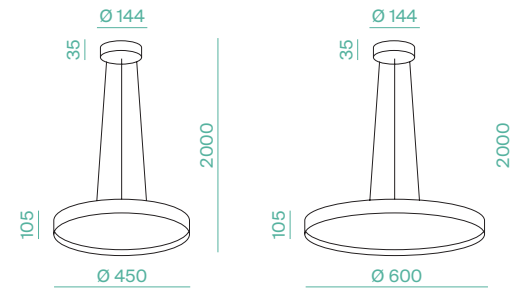

41885
41887

41886
41888



A+B SOFFITTO DALI-PUSH

LED
CRI >90
PF >0.9
SDCM <6
UGR <16

| CODE | FINISHING | WATT | LUMEN | WATT LIGHT SOURCE | LUMEN LIGHT SOURCE | BEAM | KELVIN | DRIVER |
|-------|--------------|---------------|-------------|-------------------|--------------------|----------|--------|--------------------------------------|
| 41889 | Bianco/White | ↓ 26W + ↑ 12W | 2412 + 1471 | 26W+11,6W | 3236+1501 | 90°+120° | 3000K | 38W 30-40V 1050mA |
| 41891 | Bianco/White | ↓ 26W+ ↑ 12W | 2629 + 1603 | 26W+11,6W | 3603+1636 | 90°+120° | 4000K | 38W 30-40V 1050mA |
| 41890 | Bianco/White | ↓ 38W+ ↑ 20W | 3570 + 2317 | 36W+20W | 4109+2685 | 90°+120° | 3000K | 38W 30-40V 1050mA + 20W 30-40V 500mA |
| 41892 | Bianco/White | ↓ 38W+ ↑ 20W | 3892 + 2525 | 36W+20W | 4782+2926 | 90°+120° | 4000K | 38W 30-40V 1050mA + 20W 30-40V 500mA |

INSTALLAZIONE APPLICATION



Soffitto/
Ceiling

DISEGNI TECNICI TECHNICAL DRAWINGS

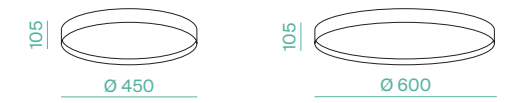

41889
41891

41890
41892



KLIK_KLAK & KLIK_KLAK MINI

KLIK_KLAK è un sistema completo declinabile in diverse tipologie di installazione: incasso a raso, a soffitto e a sospensione. I raccordi disponibili permettono di adattarlo a qualsiasi superficie e di introdurre dei cambi di piano: in questo modo si può inserire in maniera minimale negli spazi abitativi e commerciali rendendo la luce parte integrante del progetto di design.

KLIK_KLAK is a complete system suitable for recessed, ceiling-mounted or suspended installation. The many accessories available allow different solutions including multilevel combinations; it's the ideal choice for a discreet and minimal lighting solution both in residential and commercial areas making light an integral part of the whole project.



**Installazione
a modo tuo**
Place it your
own way



Workplace + KLIK_KLAK Mini



Shop + KLIK_KLAK Mini



Bookshop + KLIK_KLAK Mini

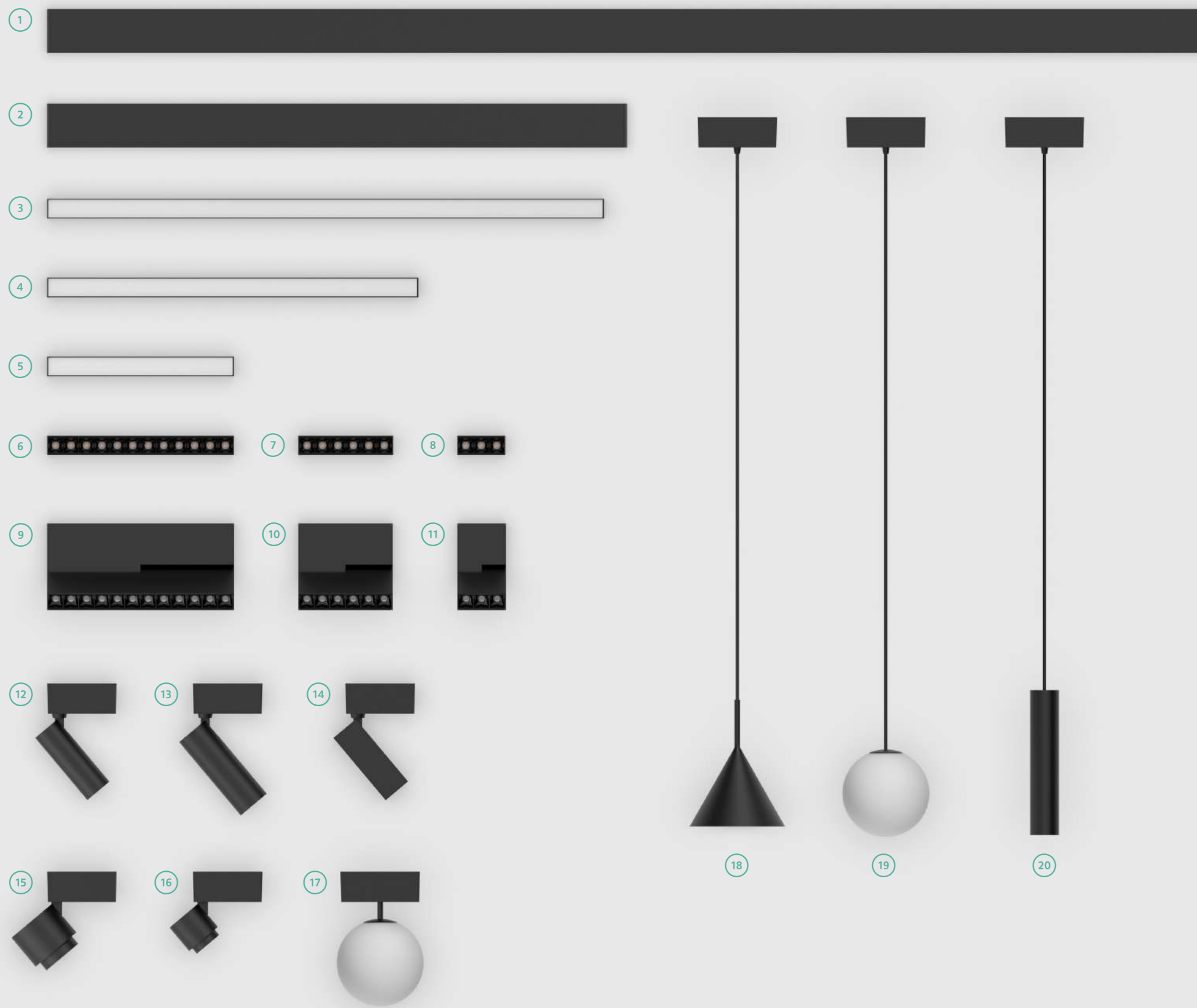

- 1 Binario 2mt
2m profile
- 2 Binario 1mt
1m profile
- 3 Luce diffusa 39W
Wide beam general lighting 39W
- 4 Luce diffusa 26W
Wide beam general lighting 26W
- 5 Luce diffusa 13W
Wide beam general lighting 13W
- 6 Luce puntiforme x12
Dots light x12
- 7 Luce puntiforme x6
Dots light x6
- 8 Luce puntiforme x3
Dots light x3
- 9 Luce puntiforme orientabile x12
Adjustable dots light x12
- 10 Luce puntiforme orientabile x6
Adjustable dots light x6
- 11 Luce puntiforme orientabile x3
Adjustable dots light x3
- 12 Proiettore 10W
Spotlight 10W
- 13 Proiettore 20W
Spotlight 20W
- 14 Proiettore Q 10W
Spotlight Q 10W
- 15 Proiettore 15W
Spotlight 15W
- 16 Proiettore 8W
Spotlight 8W
- 17 Globo
Globe
- 18 Sospensione bell
Suspension bell
- 19 Sospensione globo
Suspension globe
- 20 Sospensione cilindro
Suspension cylinder

KLIK_KLAK MINI

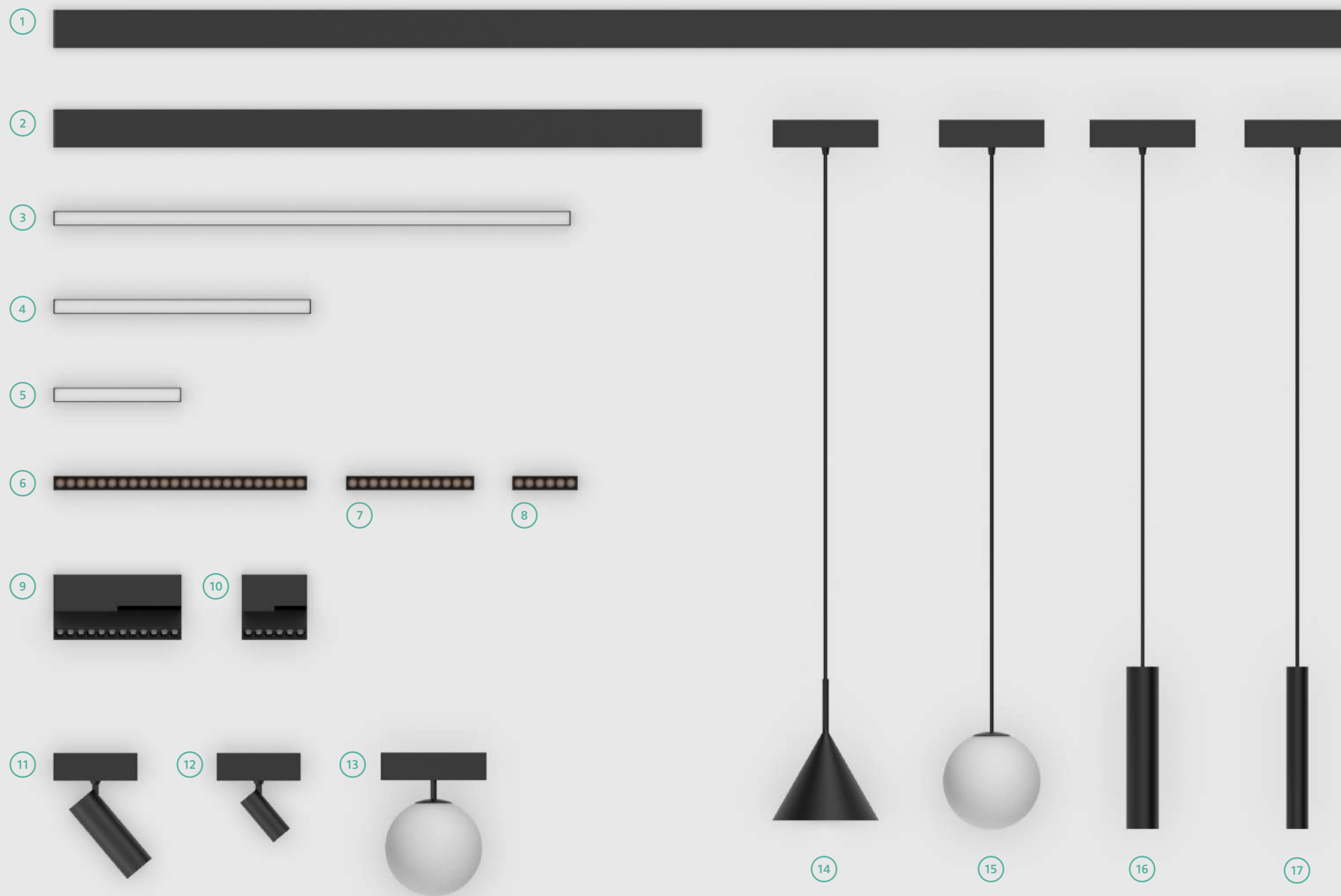

- 1 Binario 2mt
2m profile
- 2 Binario 1mt
1m profile
- 3 Luce diffusa 30W
Wide beam general lighting 30W
- 4 Luce diffusa 15W
Wide beam general lighting 15W
- 5 Luce diffusa 8W
Wide beam general lighting 8W
- 6 Luce puntiforme x24
Dots light x24
- 7 Luce puntiforme x12
Dots light x12
- 8 Luce puntiforme x6
Dots light x6
- 9 Luce puntiforme orientabile x12
Adjustable dots light x12
- 10 Luce puntiforme orientabile x6
Adjustable dots light x6
- 11 Proiettore 10W
Spotlight 10W
- 12 Proiettore 5W
Spotlight 5W
- 13 Globo
Globe
- 14 Sospensione bell
Suspension bell
- 15 Sospensione globo
Suspension globe
- 16 Sospensione cilindro 10W
Suspension cylinder 10W
- 17 Sospensione cilindro 5W
Suspension cylinder 5W

Dimensioni a confronto

Comparing dimensions

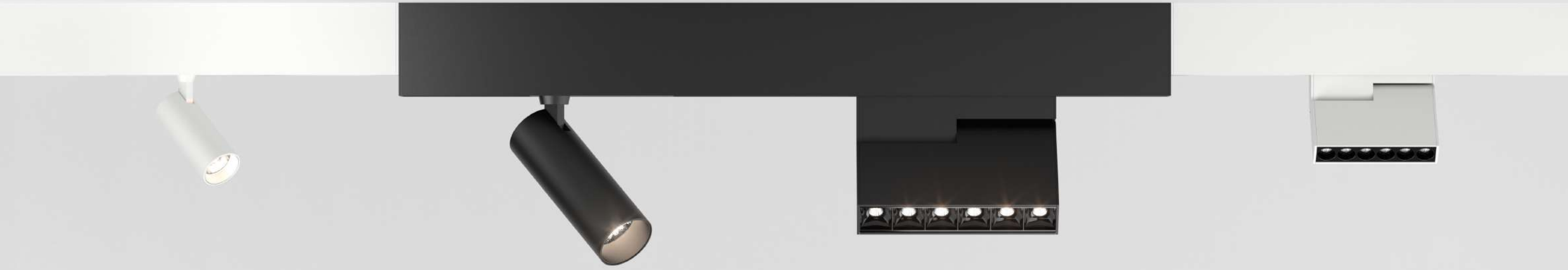

KLIK_KLAK affianca la versione MINI che, con la sua dimensione ridotta del 30% trova una collocazione ancora più minimale nell'ambito della progettazione.

L'espansione della famiglia, STD e MINI, riesce definitivamente ad incontrare le molteplici soluzioni illuminotecniche e d' arredamento.

KLIK_KLAK adds the MINI version which thanks to its dimensions, reduced by 30%, finds even a more minimal collocation during the interior designing process.

The whole range, STD and MINI, is definitely able to meet all lighting and interior design requirements.

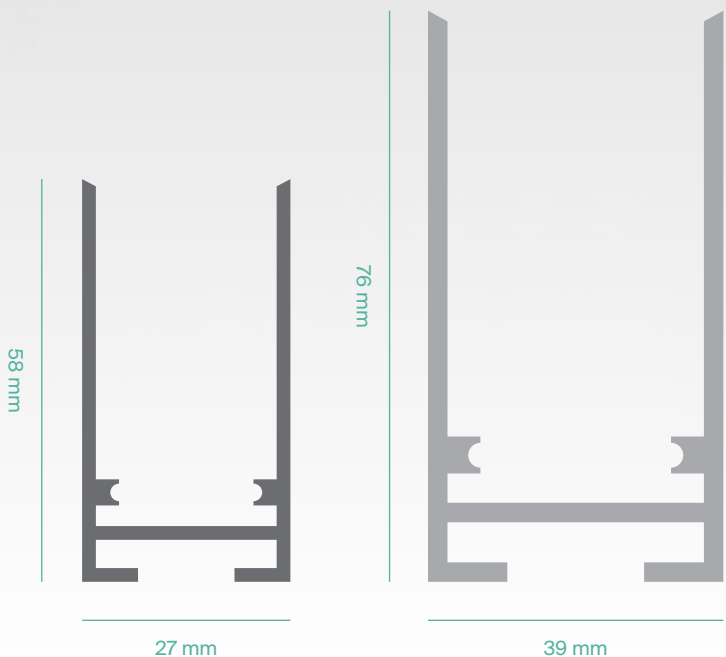

Sistema magnetico

Magnetic system

Il sistema KLIK_KLAK sfrutta la potenza del magnete permanente NdFeB, il più potente del mondo. L'inserimento e lo spostamento dei corpi illuminanti con fissaggio magnetico risulta estremamente semplice e sicuro da maneggiare grazie all'alimentazione a 24V. L'ampliamento degli accessori completa un'offerta in grado di "giocare" con la luce.

Tutti gli apparecchi KLIK_KLAK sono dimmerabili 0-10V solamente utilizzando i drivers da noi forniti. Massimo wattaggio in serie 150W per una lunghezza massima di 10m.

KLIK_KLAK magnetic system counts on the power of NdFeB permanent magnet, the most powerful in the world. The installation and the eventual shifting of the fittings from one place to another on the low voltage 24V profile is extremely simple and safe. The wider range of accessories completes an offer which allows to "play" with light.

All KLIK_KLAK fittings are 0-10V dimmable only using the drivers provided by us. Max series wattage 150W for a maximum length of 10m.

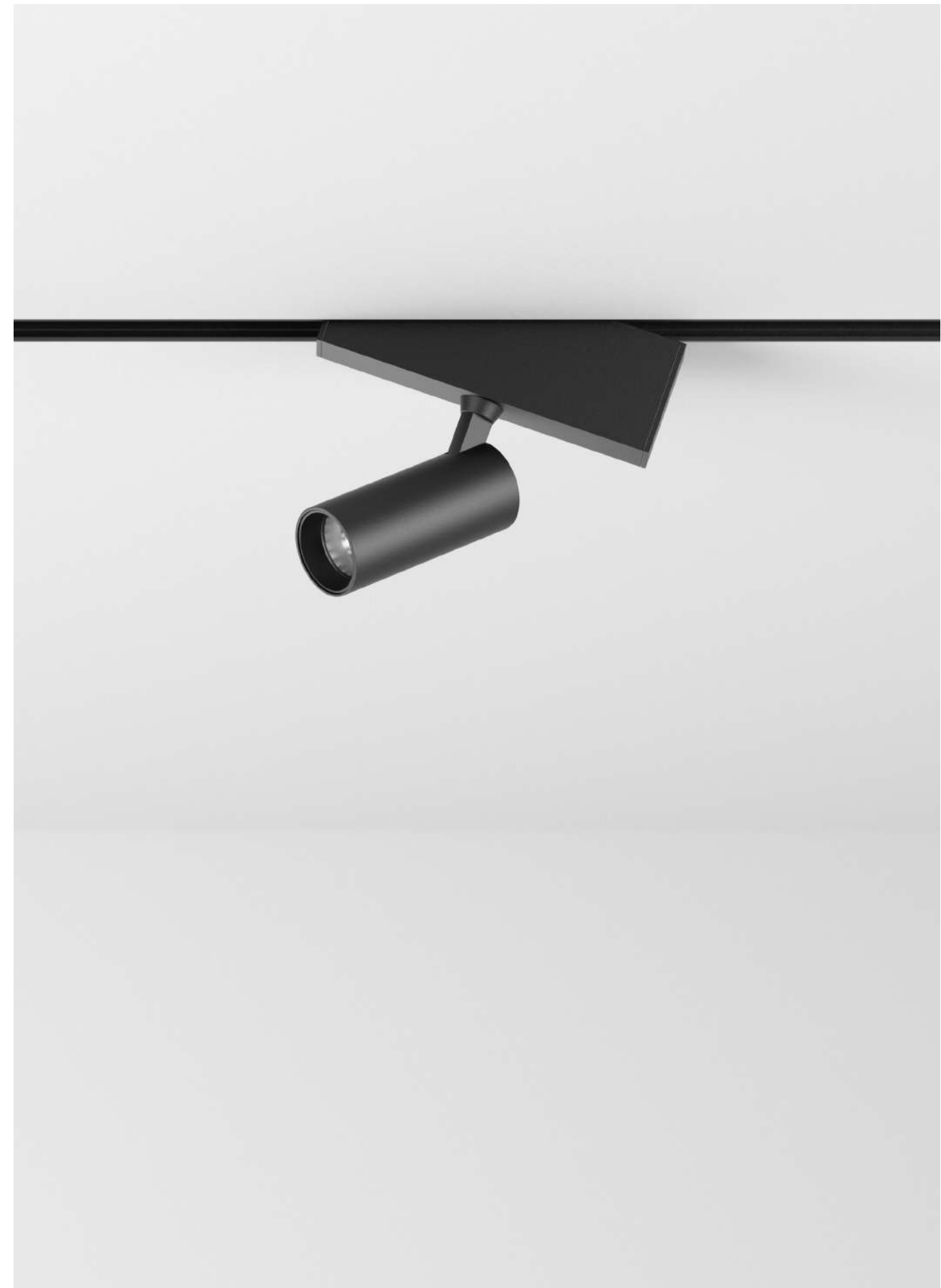



Bedroom + KLIK_KLAK Mini



Anche negli ambienti più esclusivi KLIK_KLAK si distingue per la sua integrabilità nello spazio, definendo e completando qualsiasi progetto.

Even in the most exclusive surroundings, KLIK_KLAK distinguishes itself for its full integration in the space, marking and completing any project.

Executive Office + KLIK_KLAK Mini

KLIK KLAK PROIETTORE

LED CRI >90
PF >0.5
SDCM <3

| CODE | FINISHING | WATT | LUMEN | WATT LIGHT SOURCE | LUMEN LIGHT SOURCE | BEAM | KELVIN |
|-------|--------------|------|-------|-------------------|--------------------|------|--------|
| 41111 | Nero/Black | 10W | 749 | 8W | 900 | 36° | 3000K |
| 41112 | Bianco/White | 10W | 749 | 8W | 900 | 36° | 3000K |
| 41179 | Nero/Black | 10W | 870 | 8W | 1100 | 36° | 4000K |
| 41192 | Bianco/White | 10W | 870 | 8W | 1100 | 36° | 4000K |
| 41772 | Nero/Black | 20W | 1450 | 16W | 1870 | 36° | 3000K |
| 41773 | Bianco/White | 20W | 1450 | 16W | 1870 | 36° | 3000K |

INSTALLAZIONE APPLICATION



Binario magnetico/
Magnetic track

DISEGNI TECNICI TECHNICAL DRAWINGS

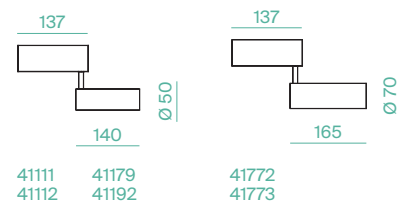

REGOLAZIONI ADJUSTABILITY



KLIK KLAK PROIETTORE

LED CRI >90
PF >0.5
SDCM <3

| CODE | FINISHING | WATT | LUMEN | WATT LIGHT SOURCE | LUMEN LIGHT SOURCE | BEAM | KELVIN |
|-------|--------------|------|-------|-------------------|--------------------|------|--------|
| 41176 | Nero/Black | 8W | 404 | 6W | 755 | 36° | 3000K |
| 41175 | Bianco/White | 8W | 404 | 6W | 755 | 36° | 3000K |
| 41178 | Nero/Black | 15W | 904 | 12W | 1395 | 36° | 3000K |
| 41177 | Bianco/White | 15W | 904 | 12W | 1395 | 36° | 3000K |
| 41214 | Nero/Black | 8W | 483 | 6W | 816 | 36° | 4000K |
| 41213 | Bianco/White | 8W | 483 | 6W | 816 | 36° | 4000K |
| 41216 | Nero/Black | 15W | 957 | 12W | 1477 | 36° | 4000K |
| 41215 | Bianco/White | 15W | 957 | 12W | 1477 | 36° | 4000K |

INSTALLAZIONE APPLICATION



Binario magnetico/
Magnetic track

DISEGNI TECNICI TECHNICAL DRAWINGS

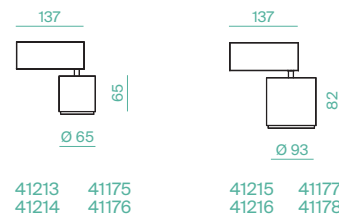

REGOLAZIONI ADJUSTABILITY



KLIK KLAK PROIETTORE Q

LED CRI >90
PF >0.5
SDCM <3

| CODE | FINISHING | WATT | LUMEN | WATT LIGHT SOURCE | LUMEN LIGHT SOURCE | BEAM | KELVIN |
|-------|--------------|------|-------|-------------------|--------------------|------|--------|
| 41770 | Nero/Black | 10W | 749 | 8W | 900 | 36° | 3000K |
| 41771 | Bianco/White | 10W | 749 | 8W | 900 | 36° | 3000K |

INSTALLAZIONE APPLICATION

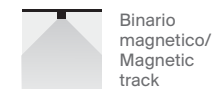

Binario magnetico/
Magnetic track

DISEGNI TECNICI TECHNICAL DRAWINGS

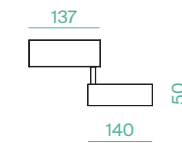

REGOLAZIONI ADJUSTABILITY



KLIK KLAK GLOBO

LED CRI >90
PF >0.5
SDCM <3

| CODE | FINISHING | WATT | LUMEN | WATT LIGHT SOURCE | LUMEN LIGHT SOURCE | BEAM | KELVIN |
|-------|--------------|------|-------|-------------------|--------------------|-------|--------|
| 41778 | Nero/Black | 10W | 680 | 8W | 1105 | DIFF. | 3000K |
| 41779 | Bianco/White | 10W | 680 | 8W | 1105 | DIFF. | 3000K |

INSTALLAZIONE APPLICATION



Binario magnetico/
Magnetic track

DISEGNI TECNICI TECHNICAL DRAWINGS

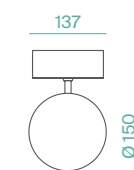

KLIK_KLAK PUNTIFORME

LED CRI >90
PF >0.5
SDCM <3

| CODE | FINISHING | WATT | LUMEN | WATT LIGHT SOURCE | LUMEN LIGHT SOURCE | BEAM | KELVIN |
|-------|--------------|------|-------|-------------------|--------------------|------|--------|
| 41119 | Nero/Black | 4W | 375 | 3W | 429 | 34° | 3000K |
| 41122 | Bianco/White | 4W | 375 | 3W | 429 | 34° | 3000K |
| 41120 | Nero/Black | 8W | 788 | 6W | 819 | 34° | 3000K |
| 41123 | Bianco/White | 8W | 788 | 6W | 819 | 34° | 3000K |
| 41121 | Nero/Black | 16W | 1519 | 12W | 1647 | 34° | 3000K |
| 41124 | Bianco/White | 16W | 1519 | 12W | 1647 | 34° | 3000K |
| 41199 | Nero/Black | 4W | 381 | 3W | 438 | 34° | 4000K |
| 41202 | Bianco/White | 4W | 381 | 3W | 438 | 34° | 4000K |
| 41200 | Nero/Black | 8W | 741 | 6W | 832 | 34° | 4000K |
| 41203 | Bianco/White | 8W | 741 | 6W | 832 | 34° | 4000K |
| 41201 | Nero/Black | 16W | 1530 | 12W | 1729 | 34° | 4000K |
| 41204 | Bianco/White | 16W | 1530 | 12W | 1729 | 34° | 4000K |

INSTALLAZIONE APPLICATION

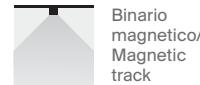

Binario magnetico/
Magnetic track

DISEGNI TECNICI TECHNICAL DRAWINGS

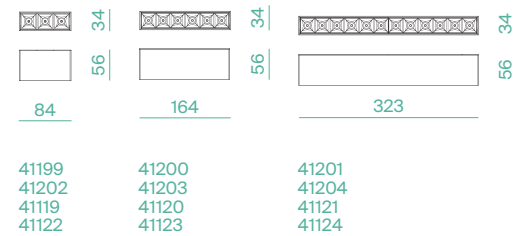

KLIK_KLAK PUNTIFORME ORIENTABILE

LED CRI >90
PF >0.5
SDCM <3

| CODE | FINISHING | WATT | LUMEN | WATT LIGHT SOURCE | LUMEN LIGHT SOURCE | BEAM | KELVIN |
|-------|--------------|------|-------|-------------------|--------------------|------|--------|
| 41125 | Nero/Black | 4W | 375 | 3W | 429 | 34° | 3000K |
| 41128 | Bianco/White | 4W | 375 | 3W | 429 | 34° | 3000K |
| 41126 | Nero/Black | 8W | 788 | 6W | 819 | 34° | 3000K |
| 41129 | Bianco/White | 8W | 788 | 6W | 819 | 34° | 3000K |
| 41127 | Nero/Black | 16W | 1519 | 12W | 1647 | 34° | 3000K |
| 41130 | Bianco/White | 16W | 1519 | 12W | 1647 | 34° | 3000K |
| 41205 | Nero/Black | 4W | 381 | 3W | 438 | 34° | 4000K |
| 41208 | Bianco/White | 4W | 381 | 3W | 438 | 34° | 4000K |
| 41206 | Nero/Black | 8W | 741 | 6W | 832 | 34° | 4000K |
| 41209 | Bianco/White | 8W | 741 | 6W | 832 | 34° | 4000K |
| 41207 | Nero/Black | 16W | 1530 | 12W | 1729 | 34° | 4000K |
| 41210 | Bianco/White | 16W | 1530 | 12W | 1729 | 34° | 4000K |

INSTALLAZIONE APPLICATION

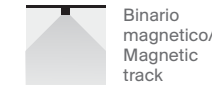

Binario magnetico/
Magnetic track

DISEGNI TECNICI TECHNICAL DRAWINGS

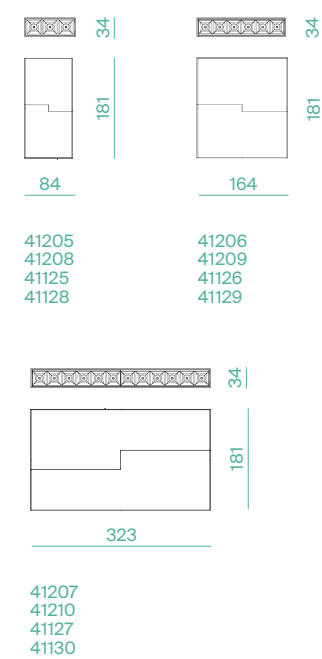

REGOLAZIONI ADJUSTABILITY



KLIK_KLAK LUCÉ DIFFUSA

LED CREE
CRI >90
PF >0.5
SDCM <3

| CODE | FINISHING | WATT | LUMEN | WATT LIGHT SOURCE | LUMEN LIGHT SOURCE | BEAM | KELVIN |
|-------|--------------|------|-------|-------------------|--------------------|------|--------|
| 41113 | Nero/Black | 13W | 962 | 10W | 1560 | 105° | 3000K |
| 41116 | Bianco/White | 13W | 962 | 10W | 1560 | 105° | 3000K |
| 41114 | Nero/Black | 26W | 1858 | 20W | 3052 | 105° | 3000K |
| 41117 | Bianco/White | 26W | 1858 | 20W | 3052 | 105° | 3000K |
| 41115 | Nero/Black | 39W | 2729 | 30W | 4368 | 105° | 3000K |
| 41118 | Bianco/White | 39W | 2729 | 30W | 4368 | 105° | 3000K |
| 41193 | Nero/Black | 13W | 965 | 10W | 1638 | 105° | 4000K |
| 41196 | Bianco/White | 13W | 965 | 10W | 1638 | 105° | 4000K |
| 41194 | Nero/Black | 26W | 2030 | 20W | 3113 | 105° | 4000K |
| 41197 | Bianco/White | 26W | 2030 | 20W | 3113 | 105° | 4000K |
| 41195 | Nero/Black | 39W | 2945 | 30W | 4543 | 105° | 4000K |
| 41198 | Bianco/White | 39W | 2945 | 30W | 4543 | 105° | 4000K |

INSTALLAZIONE APPLICATION



DISEGNI TECNICI TECHNICAL DRAWINGS



41113 41193
41116 41196



41114 41194
41117 41197

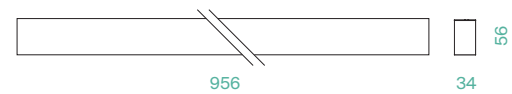

41115 41195
41118 41198

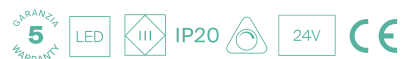

KLIK_KLAK SOSPENSIONE

LED CREE
CRI >90
PF >0.5
SDCM <3

| CODE | FINISHING | WATT | LUMEN | WATT LIGHT SOURCE | LUMEN LIGHT SOURCE | BEAM | KELVIN |
|-------|--------------|------|-------|-------------------|--------------------|------|--------|
| 41174 | Nero/Black | 10W | 749 | 8W | 900 | 36° | 3000K |
| 41173 | Bianco/White | 10W | 749 | 8W | 900 | 36° | 3000K |
| 41212 | Nero/Black | 10W | 870 | 8W | 1100 | 36° | 4000K |
| 41211 | Bianco/White | 10W | 870 | 8W | 1100 | 36° | 4000K |

INSTALLAZIONE APPLICATION



DISEGNI TECNICI TECHNICAL DRAWINGS

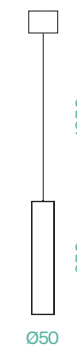

KLIK_KLAK SOSPENSIONE GLOBO

LED
CRI >90
PF >0.5
SDCM <3

| CODE | FINISHING | WATT | LUMEN | WATT LIGHT SOURCE | LUMEN LIGHT SOURCE | BEAM | KELVIN |
|-------|--------------|------|-------|-------------------|--------------------|-------|--------|
| 41774 | Nero/Black | 10W | 680 | 8W | 1105 | DIFF. | 3000K |
| 41775 | Bianco/White | 10W | 680 | 8W | 1105 | DIFF. | 3000K |

INSTALLAZIONE APPLICATION

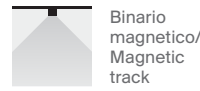

DISEGNI TECNICI TECHNICAL DRAWINGS

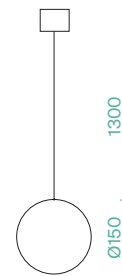

KLIK_KLAK SOSPENSIONE BELL

LED
CRI >90
PF >0.5
SDCM <3

| CODE | FINISHING | WATT | LUMEN | WATT LIGHT SOURCE | LUMEN LIGHT SOURCE | BEAM | KELVIN |
|-------|--------------|------|--------|-------------------|--------------------|------|--------|
| 41776 | Nero/Black | 10W | 415,80 | 8W | 900 | 65° | 3000K |
| 41777 | Bianco/White | 10W | 571,90 | 8W | 900 | 65° | 3000K |

INSTALLAZIONE APPLICATION

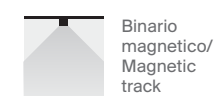

DISEGNI TECNICI TECHNICAL DRAWINGS

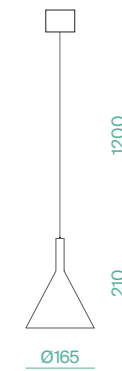

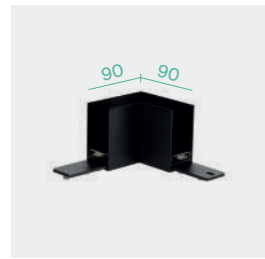
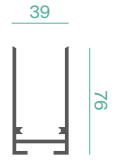

41136 - 41137



41138 - 41139



41140 - 41141

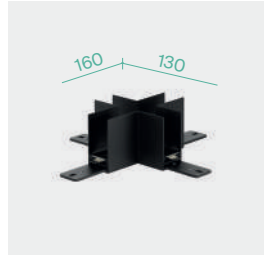

41257 - 41258

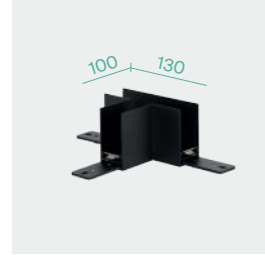

41259 - 41260



41142 - 41143



41131

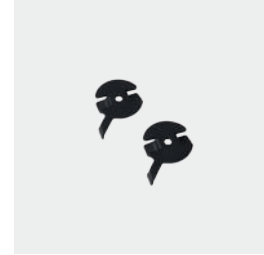

41222 - 41223



41132/A - 41133/A



41134 - 41135



41240 - 41241



42787 - 42784 - 42788 - 42785



42789 - 42786



42811 - 42808 - 42812 - 42809



42813 - 42810

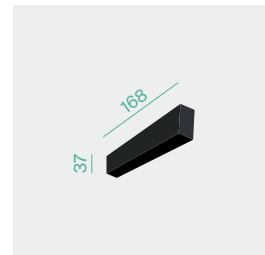

41782 - 41783

| CODE | FINISHING | DESCRIPTION |
|-------|----------------|---|
| 41109 | Nero / Black | Struttura 1mt in alluminio estruso con testate / 1mt extruded aluminium profile with end-caps |
| 41110 | Bianco / White | Struttura 1mt in alluminio estruso con testate / 1mt extruded aluminium profile with end-caps |
| 41144 | Nero / Black | Struttura 2mt in alluminio estruso con testate / 2mt extruded aluminium profile with end-caps |
| 41145 | Bianco / White | Struttura 2mt in alluminio estruso con testate / 2mt extruded aluminium profile with end-caps |
| 41146 | Nero / Black | Copertura per rasatura 1 mt/1 mt mask for plasterboard thinning |
| 41136 | Nero / Black | Angolo 90° e accessori / 90° corner with accessories |
| 41137 | Bianco / White | Angolo 90° e accessori / 90° corner with accessories |
| 41138 | Nero / Black | Angolo 90° esterno e accessori / Outer 90° corner with accessories |
| 41139 | Bianco / White | Angolo 90° esterno e accessori / Outer 90° corner with accessories |
| 41140 | Nero / Black | Angolo 90° interno e accessori / Inner 90° corner with accessories |
| 41141 | Bianco / White | Angolo 90° interno e accessori / Inner 90° corner with accessories |

| CODE | FINISHING | DESCRIPTION |
|---------|-----------------|--|
| 41142 | Nero / Black | Congiunzione elettrica con spinotti / Linear 65mm electric connection with relative 3-pins connector |
| 41143 | Bianco / White | Congiunzione elettrica con spinotti / Linear 65mm electric connection with relative 3-pins connector |
| 41131 | Nero / Black | Kit staffe incasso (2 pz) / Brackets for recessed installation (2 pcs) |
| 41222 | Nero / Black | Staffe attacco soffitto kit 2pz / Brackets for ceiling installation 2 pcs |
| 41223 | Bianco / White | Staffe attacco soffitto kit 2pz / Brackets for ceiling installation 2 pcs |
| 41132 | Acciaio / Steel | Sospensione 2mt (1 pz) / Suspension 2mt (1 pc) |
| 41132/A | Nero / Black | Sospensione con cavo alimentazione 2mt (1 pz) / Suspension 2mt with electrical wire (1 pc) |
| 41133/A | Bianco / White | Sospensione con cavo alimentazione 2mt (1 pz) / Suspension 2mt with electrical wire (1 pc) |
| 41134 | Nero / Black | Staffa connessione (1 pz) / Linear connection plate (1 pc) |
| 41135 | Bianco / White | Staffa connessione (1 pz) / Linear connection plate (1 pc) |
| 41258 | Nero / Black | Giunto a "X"/"X" connector |
| 41257 | Bianco / White | Giunto a "X"/"X" connector |
| 41260 | Nero / Black | Giunto a "T"/"T" connector |
| 41259 | Bianco / White | Giunto a "T"/"T" connector |
| 41241 | Nero / Black | Testata per alimentazione 24V / Front feed 24V |
| 41240 | Bianco / White | Testata per alimentazione 24V / Front feed 24V |
| 41782 | Nero / Black | Ponte di giunzione elettrica 168mm H.37mm / Electric bridge connector 168mm H.37mm |
| 41783 | Bianco / White | Ponte di giunzione elettrica 168mm H.37mm / Electric bridge connector 168mm H.37mm |
| 42787 | Nero / Black | Testata c/ driver 75W 230V dimm. / Front feed w/ driver 75W 230V dimm. |
| 42784 | Bianco / White | Testata c/ driver 75W 230V dimm. / Front feed w/ driver 75W 230V dimm. |
| 42788 | Nero / Black | Testata c/ driver 100W 230V dimm. / Front feed w/ driver 100W 230V dimm. |
| 42785 | Bianco / White | Testata c/ driver 100W 230V dimm. / Front feed w/ driver 100W 230V dimm. |
| 42789 | Nero / Black | Testata c/ driver 150W 230V dimm. / Front feed w/ driver 150W 230V dimm. |
| 42786 | Bianco / White | Testata c/ driver 150W 230V dimm. / Front feed w/ driver 150W 230V dimm. |
| 42811 | Nero / Black | Centrale c/ driver 75W 230V dimm. / Central feed w/ driver 75W 230V dimm. |
| 42808 | Bianco / White | Centrale c/ driver 75W 230V dimm. / Central feed w/ driver 75W 230V dimm. |
| 42812 | Nero / Black | Centrale c/ driver 100W 230V dimm. / Central feed w/ driver 100W 230V dimm. |
| 42809 | Bianco / White | Centrale c/ driver 100W 230V dimm. / Central feed w/ driver 100W 230V dimm. |
| 42813 | Nero / Black | Centrale c/ driver 150W 230V dimm. / Central feed w/ driver 150W 230V dimm. |
| 42810 | Bianco / White | Centrale c/ driver 150W 230V dimm. / Central feed w/ driver 150W 230V dimm. |

DRIVER

| CODE | WATT | V | DESCRIPTION | SIZE | MODE |
|-------|------|--------|--------------------------|---------------|--------|
| 22015 | 50W | 24V DC | Driver MW | 99x82x30mm | ON-OFF |
| 22031 | 60W | 24V DC | Driver EAGLERISE TRP | 187x45x31mm | ON-OFF |
| 22032 | 75W | 24V DC | Driver EAGLERISE TRP | 187x45x31mm | ON-OFF |
| 22016 | 100W | 24V DC | Driver MW | 129x97x30mm | ON-OFF |
| 22033 | 120W | 24V DC | Driver EAGLERISE TRP | 268x45x31mm | ON-OFF |
| 22034 | 150W | 24V DC | Driver EAGLERISE TRP | 268x45x31mm | ON-OFF |
| 22025 | 150W | 24V DC | Driver MW | 160x95x30mm | ON-OFF |
| 22017 | 200W | 24V DC | Driver MW | 215x115x30mm | ON-OFF |
| 41217 | 75W | 24V DC | Driver dimmerabile LTECH | 144x78x38.5mm | 0-10V |
| 41218 | 100W | 24V DC | Driver dimmerabile LTECH | 240x70x36mm | 0-10V |
| 41219 | 150W | 24V DC | Driver dimmerabile LTECH | 270x79x39mm | 0-10V |
| 11044 | 75W | 24V DC | Driver LTECH | 290x45x30mm | DALI |
| 11045 | 150W | 24V DC | Driver LTECH | 290x45x30mm | DALI |



KLIK_KLAK MINI PROIETTORE

LED CREE
CRI >90
PF >0.5
SDCM <3

| CODE | FINISHING | WATT | LUMEN | WATT LIGHT SOURCE | LUMEN LIGHT SOURCE | BEAM | KELVIN |
|-------|--------------|------|-------|-------------------|--------------------|------|--------|
| 41733 | Nero/Black | 6W | 423 | 5W | 630 | 30° | 3000K |
| 41734 | Bianco/White | 6W | 423 | 5W | 630 | 30° | 3000K |

INSTALLAZIONE APPLICATION



Binario magnetico/
Magnetic track

DISEGNI TECNICI TECHNICAL DRAWINGS

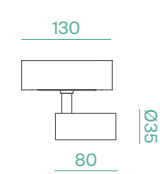

REGOLAZIONI ADJUSTABILITY

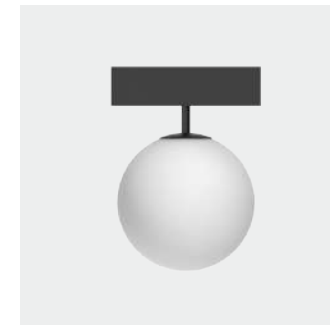

KLIK_KLAK MINI GLOBO

LED CREE
CRI >90
PF >0.5
SDCM <3

| CODE | FINISHING | WATT | LUMEN | WATT LIGHT SOURCE | LUMEN LIGHT SOURCE | BEAM | KELVIN |
|-------|--------------|------|-------|-------------------|--------------------|-------|--------|
| 41745 | Nero/Black | 10W | 680 | 8W | 1105 | DIFF. | 3000K |
| 41746 | Bianco/White | 10W | 680 | 8W | 1105 | DIFF. | 3000K |

INSTALLAZIONE APPLICATION



Binario magnetico/
Magnetic track

DISEGNI TECNICI TECHNICAL DRAWINGS

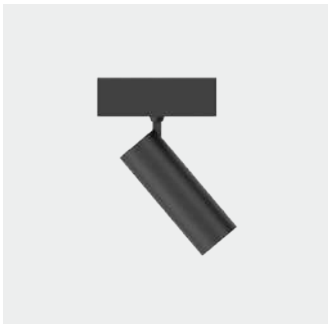
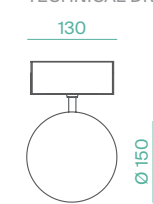

KLIK_KLAK MINI PROIETTORE

LED CREE
CRI >90
PF >0.5
SDCM <3

| CODE | FINISHING | WATT | LUMEN | WATT LIGHT SOURCE | LUMEN LIGHT SOURCE | BEAM | KELVIN |
|-------|--------------|------|-------|-------------------|--------------------|------|--------|
| 41735 | Nero/Black | 10W | 749 | 8W | 900 | 36° | 3000K |
| 41736 | Bianco/White | 10W | 749 | 8W | 900 | 36° | 3000K |

INSTALLAZIONE APPLICATION



Binario magnetico/
Magnetic track

DISEGNI TECNICI TECHNICAL DRAWINGS

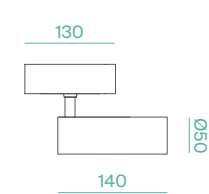

REGOLAZIONI ADJUSTABILITY



KLIK_KLAK MINI PUNTIFORME

LED CREE
CRI >90
PF >0.5
SDCM <3

| CODE | FINISHING | WATT | LUMEN | WATT LIGHT SOURCE | LUMEN LIGHT SOURCE | BEAM | KELVIN |
|-------|--------------|------|-------|-------------------|--------------------|------|--------|
| 41717 | Nero/Black | 6W | 509 | 5W | 693 | 30° | 3000K |
| 41718 | Bianco/White | 6W | 509 | 5W | 693 | 30° | 3000K |
| 41719 | Nero/Black | 12W | 1011 | 10W | 1410 | 30° | 3000K |
| 41720 | Bianco/White | 12W | 1011 | 10W | 1410 | 30° | 3000K |
| 41721 | Nero/Black | 24W | 2041 | 20W | 2750 | 30° | 3000K |
| 41722 | Bianco/White | 24W | 2041 | 20W | 2750 | 30° | 3000K |

INSTALLAZIONE APPLICATION

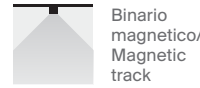

Binario magnetico/
Magnetic track

DISEGNI TECNICI TECHNICAL DRAWINGS

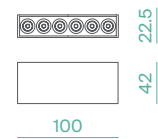

41717
41718

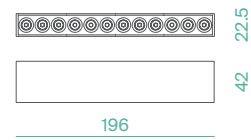

41719
41720

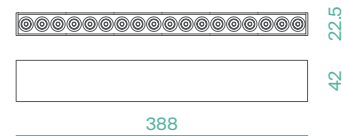

41721
41722



KLIK_KLAK MINI PUNTIFORME ORIENTABILE

LED CREE
CRI >90
PF >0.5
SDCM <3

| CODE | FINISHING | WATT | LUMEN | WATT LIGHT SOURCE | LUMEN LIGHT SOURCE | BEAM | KELVIN |
|-------|--------------|------|-------|-------------------|--------------------|------|--------|
| 41729 | Nero/Black | 8W | 681 | 6W | 819 | 30° | 3000K |
| 41730 | Bianco/White | 8W | 681 | 6W | 819 | 30° | 3000K |
| 41731 | Nero/Black | 16W | 1198 | 12W | 1647 | 30° | 3000K |
| 41732 | Bianco/White | 16W | 1198 | 12W | 1647 | 30° | 3000K |

INSTALLAZIONE APPLICATION



Binario magnetico/
Magnetic track

DISEGNI TECNICI TECHNICAL DRAWINGS

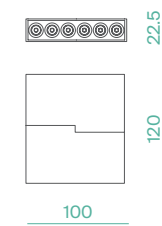

41729
41730

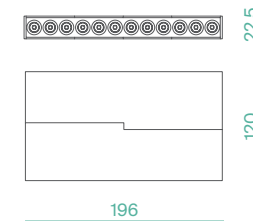

41731
41732

REGOLAZIONI ADJUSTABILITY



KLIK_KLAK MINI LUCÉ DIFFUSA

LED CREE
CRI >90
PF >0.5
SDCM <3

| CODE | FINISHING | WATT | LUMEN | WATT LIGHT SOURCE | LUMEN LIGHT SOURCE | BEAM | KELVIN |
|-------|--------------|------|-------|-------------------|--------------------|------|--------|
| 41723 | Nero/Black | 8W | 605 | 6W | 950 | 105° | 3000K |
| 41724 | Bianco/White | 8W | 605 | 6W | 950 | 105° | 3000K |
| 41725 | Nero/Black | 15W | 1013 | 12W | 1900 | 105° | 3000K |
| 41726 | Bianco/White | 15W | 1013 | 12W | 1900 | 105° | 3000K |
| 41727 | Nero/Black | 30W | 1970 | 23W | 3420 | 105° | 3000K |
| 41728 | Bianco/White | 30W | 1970 | 23W | 3420 | 105° | 3000K |

INSTALLAZIONE APPLICATION



Binario magnetico/
Magnetic track

DISEGNI TECNICI TECHNICAL DRAWINGS



41723
41724



41725
41726



41727
41728



KLIK_KLAK MINI SOSPENSIONE

LED CREE
CRI >90
PF >0.5
SDCM <3

| CODE | FINISHING | WATT | LUMEN | WATT LIGHT SOURCE | LUMEN LIGHT SOURCE | BEAM | KELVIN |
|-------|--------------|------|-------|-------------------|--------------------|------|--------|
| 41739 | Nero/Black | 6W | 423 | 5W | 630 | 30° | 3000K |
| 41740 | Bianco/White | 6W | 423 | 5W | 630 | 30° | 3000K |
| 41737 | Nero/Black | 10W | 749 | 8W | 900 | 36° | 3000K |
| 41738 | Bianco/White | 10W | 749 | 8W | 900 | 36° | 3000K |

INSTALLAZIONE APPLICATION



Binario magnetico/
Magnetic track

DISEGNI TECNICI TECHNICAL DRAWINGS

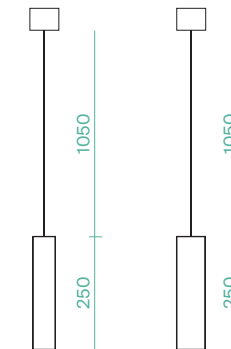

Ø35

41739
41740

Ø50

41737
41738



KLIK_KLAK MINI SOSPENSIONE GLOBO

LED CREE
CRI >90
PF >0.5
SDCM <3

| CODE | FINISHING | WATT | LUMEN | WATT LIGHT SOURCE | LUMEN LIGHT SOURCE | BEAM | KELVIN |
|-------|--------------|------|-------|-------------------|--------------------|-------|--------|
| 41741 | Nero/Black | 10W | 680 | 8W | 1105 | DIFF. | 3000K |
| 41742 | Bianco/White | 10W | 680 | 8W | 1105 | DIFF. | 3000K |

INSTALLAZIONE APPLICATION

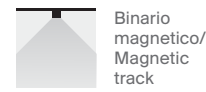

DISEGNI TECNICI TECHNICAL DRAWINGS



KLIK_KLAK MINI SOSPENSIONE BELL

LED CREE
CRI >90
PF >0.5
SDCM <3

| CODE | FINISHING | WATT | LUMEN | WATT LIGHT SOURCE | LUMEN LIGHT SOURCE | BEAM | KELVIN |
|-------|--------------|------|-------|-------------------|--------------------|------|--------|
| 41743 | Nero/Black | 10W | 415 | 8W | 900 | 65° | 3000K |
| 41744 | Bianco/White | 10W | 571 | 8W | 900 | 65° | 3000K |

INSTALLAZIONE APPLICATION

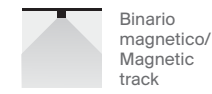

DISEGNI TECNICI TECHNICAL DRAWINGS

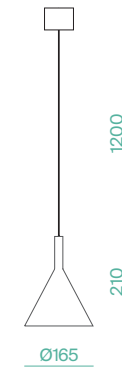

KLIK_KLAK_MINI
ACCESSORI
ACCESSORIES

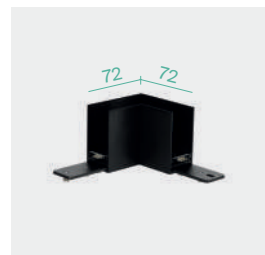
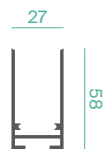

41747 - 41748

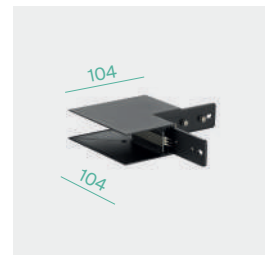

41751 - 41752



41749 - 41750

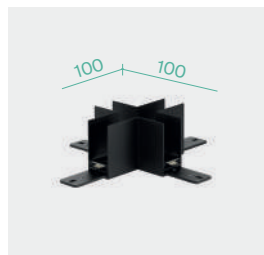

41753 - 41754

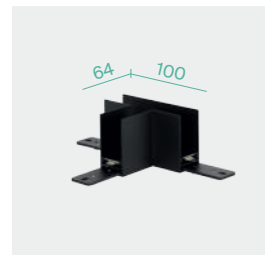

41755 - 41756



41759 - 41760



41763

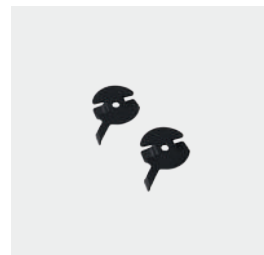

41761 - 41762



41132/A - 41133/A



41757 - 41758



41765 - 41766



41784 - 41788



41785 - 41789 - 41786 - 41790



42817 - 42814



42818 - 42815 - 42819 - 42816

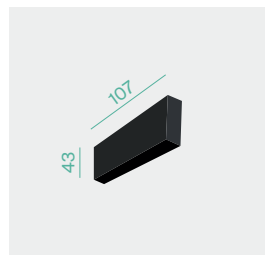

41780 - 41781

| CODE | FINISHING | DESCRIPTION |
|-------|----------------|---|
| 41713 | Nero / Black | Struttura 1mt in alluminio estruso con testate / 1mt extruded aluminium profile with end-caps |
| 41714 | Bianco / White | Struttura 1mt in alluminio estruso con testate / 1mt extruded aluminium profile with end-caps |
| 41715 | Nero / Black | Struttura 2mt in alluminio estruso con testate / 2mt extruded aluminium profile with end-caps |
| 41716 | Bianco / White | Struttura 2mt in alluminio estruso con testate / 2mt extruded aluminium profile with end-caps |
| 41764 | Nero / Black | Copertura per rasatura 1 mt/1 mt mask for plasterboard thinning |
| 41747 | Nero / Black | Angolo 90° con spinotti e accessori/ 90° corner with accessories |
| 41748 | Bianco / White | Angolo 90° con spinotti e accessori/ 90° corner with accessories |
| 41751 | Nero / Black | Angolo 90° esterno e accessori/ Outer 90° corner with accessories |
| 41752 | Bianco / White | Angolo 90° esterno e accessori/ Outer 90° corner with accessories |
| 41749 | Nero / Black | Angolo 90° interno e accessori/ Inner 90° corner with accessories |
| 41750 | Bianco / White | Angolo 90° interno e accessori/ Inner 90° corner with accessories |

KLIK_KLAK_MINI
ACCESSORI
ACCESSORIES

| CODE | FINISHING | DESCRIPTION |
|---------|----------------|--|
| 41759 | Nero / Black | Congiunzione elettrica con spinotti/ Linear electric connection with relative 3-pins connector |
| 41760 | Bianco / White | Congiunzione elettrica con spinotti/ Linear electric connection with relative 3-pins connector |
| 41763 | Nero / Black | Kit staffe incasso (2 pz)/ Brackets for recessed installation (2 pcs) |
| 41761 | Nero / Black | Staffe attacco soffitto kit 2pz/ Brackets for ceiling installation 2 pcs |
| 41762 | Bianco / White | Staffe attacco soffitto kit 2pz/ Brackets for ceiling installation 2 pcs |
| 41132 | Acciaio/Steel | Sospensione 2mt (1 pz)/ Suspension 2mt (1 pc) |
| 41132/A | Nero / Black | Sospensione con cavo alimentazione 2mt (1 pz)/ Suspension 2mt with electrical wire (1 pc) |
| 41133/A | Bianco / White | Sospensione con cavo alimentazione 2mt (1 pz)/ Suspension 2mt with electrical wire (1 pc) |
| 41757 | Nero / Black | Staffa connessione (1 pz)/ Linear connection plate (1 pc) |
| 41758 | Bianco / White | Staffa connessione (1 pz)/ Linear connection plate (1 pc) |
| 41753 | Nero / Black | Giunto a "X"/"X" connector |
| 41754 | Bianco / White | Giunto a "X"/"X" connector |
| 41755 | Nero / Black | Giunto a "T"/"T" connector |
| 41756 | Bianco / White | Giunto a "T"/"T" connector |
| 41765 | Nero / Black | Testata per alimentazione 24V/Front feed 24V |
| 41766 | Bianco / White | Testata per alimentazione 24V/Front feed 24V |
| 41780 | Nero / Black | Ponte di giunzione elettrica 107mm H.43mm/Electric bridge connector 107mm H.43mm |
| 41781 | Bianco / White | Ponte di giunzione elettrica 107mm H.43mm/Electric bridge connector 107mm H.43mm |
| 41784 | Nero / Black | Testata c/ driver 60W 230V dimm./Front feed w/ driver 60W 230V dimm. |
| 41788 | Bianco / White | Testata c/ driver 60W 230V dimm./Front feed w/ driver 60W 230V dimm. |
| 41785 | Nero / Black | Testata c/ driver 100W 230V dimm./Front feed w/ driver 10W 230V dimm. |
| 41789 | Bianco / White | Testata c/ driver 100W 230V dimm./Front feed w/ driver 100W 230V dimm. |
| 41786 | Nero / Black | Testata c/ driver 150W 230V dimm./Front feed w/ driver 150W 230V dimm. |
| 41790 | Bianco / White | Testata c/ driver 150W 230V dimm./Front feed w/ driver 150W 230V dimm. |
| 42817 | Nero / Black | Centrale c/ driver 60W 230V dimm./Central feed w/ driver 60W 230V dimm. |
| 42814 | Bianco / White | Centrale c/ driver 60W 230V dimm./Central feed w/ driver 60W 230V dimm. |
| 42818 | Nero / Black | Centrale c/ driver 100W 230V dimm./Central feed w/ driver 10W 230V dimm. |
| 42815 | Bianco / White | Centrale c/ driver 100W 230V dimm./Central feed w/ driver 100W 230V dimm. |
| 42819 | Nero / Black | Centrale c/ driver 150W 230V dimm./Central feed w/ driver 150W 230V dimm. |
| 42816 | Bianco / White | Centrale c/ driver 150W 230V dimm./Central feed w/ driver 150W 230V dimm. |

DRIVER

| CODE | WATT | V | DESCRIPTION | SIZE | MODE |
|-------|------|--------|--------------------------|---------------|--------|
| 22015 | 50W | 24V DC | Driver MW | 99x82x30mm | ON-OFF |
| 22031 | 60W | 24V DC | Driver EAGLERISE TRP | 187x45x31mm | ON-OFF |
| 22032 | 75W | 24V DC | Driver EAGLERISE TRP | 187x45x31mm | ON-OFF |
| 22016 | 100W | 24V DC | Driver MW | 129x97x30mm | ON-OFF |
| 22033 | 120W | 24V DC | Driver EAGLERISE TRP | 268x45x31mm | ON-OFF |
| 22034 | 150W | 24V DC | Driver EAGLERISE TRP | 268x45x31mm | ON-OFF |
| 22025 | 150W | 24V DC | Driver MW | 160x95x30mm | ON-OFF |
| 22017 | 200W | 24V DC | Driver MW | 215x115x30mm | ON-OFF |
| 41217 | 75W | 24V DC | Driver dimmerabile LTECH | 144x78x38.5mm | 0-10V |
| 41218 | 100W | 24V DC | Driver dimmerabile LTECH | 240x70x36mm | 0-10V |
| 41219 | 150W | 24V DC | Driver dimmerabile LTECH | 270x79x39mm | 0-10V |
| 11044 | 75W | 24V DC | Driver LTECH | 290x45x30mm | DALI |
| 11045 | 150W | 24V DC | Driver LTECH | 290x45x30mm | DALI |

DEEP_EVO

DEEP_EVO, il faretto a incasso dalle mille possibilità. DEEP_EVO si adatta perfettamente alle tue esigenze di illuminazione, creando i punti luce di cui necessiti per ogni ambiente. La qualità dei suoi materiali e la sua funzionalità permettono di illuminare gli spazi in modo elegante e sofisticato, soprattutto quando si tratta di situazioni espositive che richiedono una luce mirata e funzionale.

DEEP_EVO the recessed downlight with thousands of options available. DEEP_EVO perfectly fits your lighting requirements providing the right light solution to any space. The quality of the materials used and its functionality allow an elegant and sophisticated lighting result especially when talking about accent light where you need a specific and functional solution.



Combinazioni Combinations

Grazie alla sua versatilità, puoi personalizzarlo scegliendo tra diverse opzioni di driver, montaggio, potenza, colore del riflettore e della cornice, e orientabilità.

Thanks to its versatility, you can personalize your downlight picking up among the various options: driver, installation mode, power, adjustable/fix and various reflector and trim finishing combinations.



POTENZA POWER



FASCIO BEAM



FINITURA CORPO BODY FINISHING

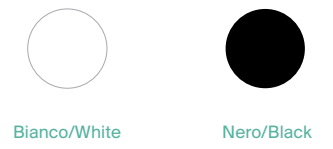

FINITURA RIFLETTORE REFLECTOR FINISHING

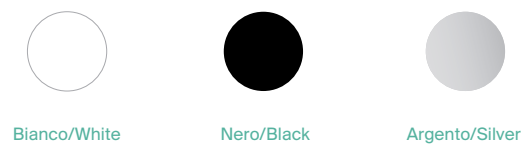

ORIENTAMENTO POSITIONING

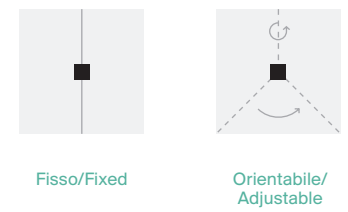

FORMA SHAPE

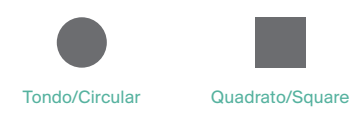

DRIVER

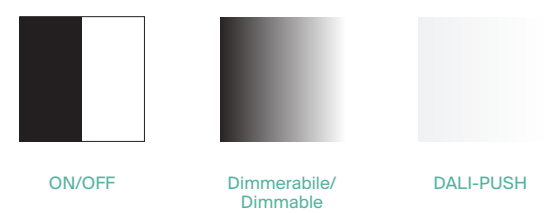



DEEP_EVO FIX

| CODE | FINISHING BODY | FINISHING REFLECTOR | MODULI |
|-------|----------------|---------------------|-----------|
| 71582 | Bianco/White | Bianco/White | Pg. 62-63 |
| 71583 | Bianco/White | Nero/Black | Pg. 62-63 |
| 71584 | Bianco/White | Silver | Pg. 62-63 |
| 71585 | Nero/Black | Bianco/White | Pg. 62-63 |
| 71586 | Nero/Black | Nero/Black | Pg. 62-63 |
| 71587 | Nero/Black | Silver | Pg. 62-63 |



DEEP_EVO LESS FIX

| CODE | FINISHING BODY | FINISHING REFLECTOR | MODULI |
|-------|----------------|---------------------|-----------|
| 71594 | Bianco/White | Bianco/White | Pg. 62-63 |
| 71595 | Bianco/White | Nero/Black | Pg. 62-63 |
| 71596 | Bianco/White | Silver | Pg. 62-63 |



DEEP_EVO ADJUSTABLE

| CODE | FINISHING BODY | FINISHING REFLECTOR | MODULI |
|-------|----------------|---------------------|-----------|
| 71588 | Bianco/White | Bianco/White | Pg. 62-63 |
| 71589 | Bianco/White | Nero/Black | Pg. 62-63 |
| 71590 | Bianco/White | Silver | Pg. 62-63 |
| 71591 | Nero/Black | Bianco/White | Pg. 62-63 |
| 71592 | Nero/Black | Nero/Black | Pg. 62-63 |
| 71593 | Nero/Black | Silver | Pg. 62-63 |

REGOLAZIONI ADJUSTABILITY



DEEP_EVO LESS ADJUSTABLE

| CODE | FINISHING BODY | FINISHING REFLECTOR | MODULI |
|-------|----------------|---------------------|-----------|
| 71597 | Bianco/White | Bianco/White | Pg. 62-63 |
| 71598 | Bianco/White | Nero/Black | Pg. 62-63 |
| 71599 | Bianco/White | Silver | Pg. 62-63 |

REGOLAZIONI ADJUSTABILITY

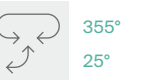

INSTALLAZIONE APPLICATION



DISEGNI TECNICI C/ MODULO LED TECHNICAL DRAWING W/ LED MODULE

LED Module 9W

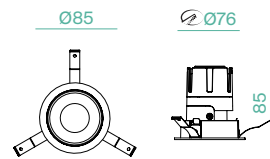

LED Module 12W-15W

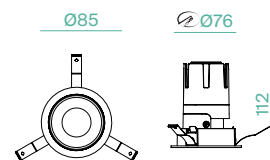

INSTALLAZIONE APPLICATION



DISEGNI TECNICI C/ MODULO LED TECHNICAL DRAWING W/ LED MODULE

LED Module 9W

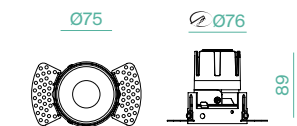

LED Module 12W-15W

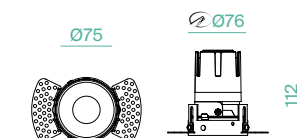



DEEP_EVO_GU10 FIX

| CODE | FINISHING BODY | FINISHING REFLECTOR | PLT |
|-------|----------------|---------------------|------|
| 71645 | Bianco/White | Bianco/White | GU10 |
| 71646 | Bianco/White | Nero/Black | GU10 |
| 71647 | Bianco/White | Silver | GU10 |
| 71651 | Nero/Black | Bianco/White | GU10 |
| 71652 | Nero/Black | Nero/Black | GU10 |
| 71653 | Nero/Black | Silver | GU10 |



DEEP_EVO LESS_GU10 FIX

| CODE | FINISHING BODY | FINISHING REFLECTOR | PLT |
|-------|----------------|---------------------|------|
| 71657 | Bianco/White | Bianco/White | GU10 |
| 71658 | Bianco/White | Nero/Black | GU10 |
| 71659 | Bianco/White | Silver | GU10 |



DEEP_EVO_GU10 ADJUSTABLE

| CODE | FINISHING BODY | FINISHING REFLECTOR | PLT |
|-------|----------------|---------------------|------|
| 71648 | Bianco/White | Bianco/White | GU10 |
| 71649 | Bianco/White | Nero/Black | GU10 |
| 71650 | Bianco/White | Silver | GU10 |
| 71654 | Nero/Black | Bianco/White | GU10 |
| 71655 | Nero/Black | Nero/Black | GU10 |
| 71656 | Nero/Black | Silver | GU10 |

REGOLAZIONI ADJUSTABILITY



DEEP_EVO LESS_GU10 ADJUSTABLE

| CODE | FINISHING BODY | FINISHING REFLECTOR | PLT |
|-------|----------------|---------------------|------|
| 71660 | Bianco/White | Bianco/White | GU10 |
| 71661 | Bianco/White | Nero/Black | GU10 |
| 71662 | Bianco/White | Silver | GU10 |

REGOLAZIONI ADJUSTABILITY

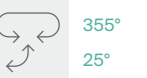

INSTALLAZIONE APPLICATION



DISEGNI TECNICI TECHNICAL DRAWING

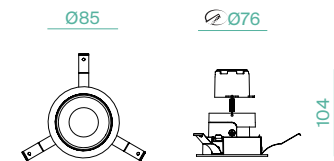

INSTALLAZIONE APPLICATION



DISEGNI TECNICI TECHNICAL DRAWING

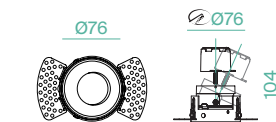



DEEP_EVO GRANDE FIX

| CODE | FINISHING BODY | FINISHING REFLECTOR | MODULI |
|-------|----------------|---------------------|-----------|
| 71729 | Bianco/White | Bianco/White | Pg. 62-63 |
| 71730 | Bianco/White | Nero/Black | Pg. 62-63 |
| 71731 | Bianco/White | Silver | Pg. 62-63 |
| 71732 | Nero/Black | Bianco/White | Pg. 62-63 |
| 71733 | Nero/Black | Nero/Black | Pg. 62-63 |
| 71734 | Nero/Black | Silver | Pg. 62-63 |



DEEP_EVO LESS GRANDE FIX

| CODE | FINISHING BODY | FINISHING REFLECTOR | MODULI |
|-------|----------------|---------------------|-----------|
| 71741 | Bianco/White | Bianco/White | Pg. 62-63 |
| 71742 | Bianco/White | Nero/Black | Pg. 62-63 |
| 71743 | Bianco/White | Silver | Pg. 62-63 |



DEEP_EVO GRANDE ADJUSTABLE

| CODE | FINISHING BODY | FINISHING REFLECTOR | MODULI |
|-------|----------------|---------------------|-----------|
| 71735 | Bianco/White | Bianco/White | Pg. 62-63 |
| 71736 | Bianco/White | Nero/Black | Pg. 62-63 |
| 71737 | Bianco/White | Silver | Pg. 62-63 |
| 71738 | Nero/Black | Bianco/White | Pg. 62-63 |
| 71739 | Nero/Black | Nero/Black | Pg. 62-63 |
| 71740 | Nero/Black | Silver | Pg. 62-63 |

REGOLAZIONI ADJUSTABILITY



DEEP_EVO LESS GRANDE ADJUSTABLE

| CODE | FINISHING BODY | FINISHING REFLECTOR | MODULI |
|-------|----------------|---------------------|-----------|
| 71744 | Bianco/White | Bianco/White | Pg. 62-63 |
| 71745 | Bianco/White | Nero/Black | Pg. 62-63 |
| 71746 | Bianco/White | Silver | Pg. 62-63 |

REGOLAZIONI ADJUSTABILITY

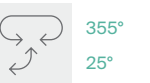

INSTALLAZIONE APPLICATION



Incasso/
Recessed

DISEGNI TECNICI C/ MODULO LED TECHNICAL DRAWING W/ LED MODULE

LED Module 20W-24W

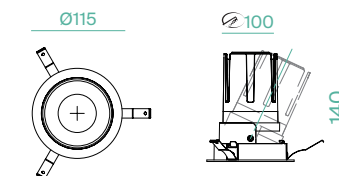

INSTALLAZIONE APPLICATION



Incasso a raso/
Recessed

DISEGNI TECNICI C/ MODULO LED TECHNICAL DRAWING W/ LED MODULE

LED Module 20W-24W

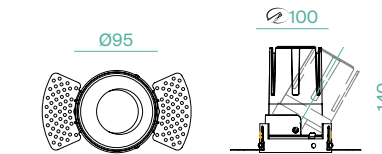

DEEP_EVO_Q FIX/ADJ



| CODE | FINISHING BODY | FINISHING REFLECTOR | MODULI |
|-------|----------------|---------------------|-----------|
| 71705 | Bianco/White | Bianco/White | Pg. 62-63 |
| 71706 | Bianco/White | Nero/Black | Pg. 62-63 |
| 71707 | Bianco/White | Silver | Pg. 62-63 |
| 71708 | Nero/Black | Bianco/White | Pg. 62-63 |
| 71709 | Nero/Black | Nero/Black | Pg. 62-63 |
| 71710 | Nero/Black | Silver | Pg. 62-63 |

REGOLAZIONI
ADJUSTABILITY



INSTALLAZIONE
APPLICATION



Incasso/
Recessed

DISEGNI TECNICI C/ MODULO LED
TECHNICAL DRAWING W/ LED MODULE

LED Module 9W

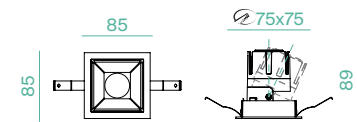

LED Module 12W-15W

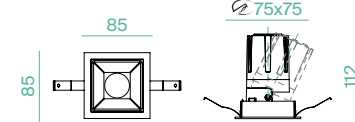

DEEP_EVO_Q_GU10 FIX/ADJ



| CODE | FINISHING BODY | FINISHING REFLECTOR | PLT |
|-------|----------------|---------------------|------|
| 71714 | Bianco/White | Bianco/White | GU10 |
| 71715 | Bianco/White | Nero/Black | GU10 |
| 71716 | Bianco/White | Silver | GU10 |
| 71717 | Nero/Black | Bianco/White | GU10 |
| 71718 | Nero/Black | Nero/Black | GU10 |
| 71719 | Nero/Black | Silver | GU10 |

REGOLAZIONI
ADJUSTABILITY

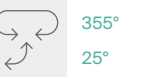

INSTALLAZIONE
APPLICATION



Incasso/
Recessed

DISEGNI TECNICI
TECHNICAL DRAWING

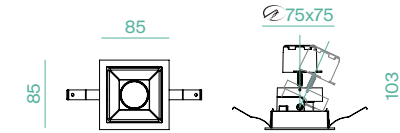

DEEP_EVO LESS_Q FIX/ADJ



| CODE | FINISHING BODY | FINISHING REFLECTOR | MODULI |
|-------|----------------|---------------------|-----------|
| 71711 | Bianco/White | Bianco/White | Pg. 62-63 |
| 71712 | Bianco/White | Nero/Black | Pg. 62-63 |
| 71713 | Bianco/White | Silver | Pg. 62-63 |

REGOLAZIONI
ADJUSTABILITY



INSTALLAZIONE
APPLICATION



Incasso a raso/
Recessed

DISEGNI TECNICI C/ MODULO LED
TECHNICAL DRAWING W/ LED MODULE

LED Module 9W

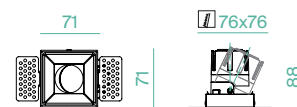

LED Module 12W-15W

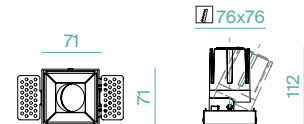

DEEP_EVO LESS_Q_GU10 FIX/ADJ



| CODE | FINISHING BODY | FINISHING REFLECTOR | PLT |
|-------|----------------|---------------------|------|
| 71720 | Bianco/White | Bianco/White | GU10 |
| 71721 | Bianco/White | Nero/Black | GU10 |
| 71722 | Bianco/White | Silver | GU10 |

REGOLAZIONI
ADJUSTABILITY

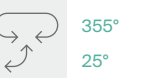

INSTALLAZIONE
APPLICATION



Incasso a raso/
Recessed

DISEGNI TECNICI
TECHNICAL DRAWING

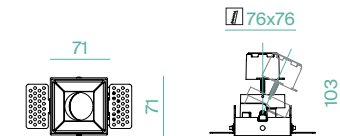



DEEP_EVO_Q GRANDE FIX/ADJ

| CODE | FINISHING BODY | FINISHING REFLECTOR | MODULI |
|-------|----------------|---------------------|-----------|
| 71723 | Bianco/White | Bianco/White | Pg. 62-63 |
| 71724 | Bianco/White | Nero/Black | Pg. 62-63 |
| 71725 | Bianco/White | Silver | Pg. 62-63 |
| 71726 | Nero/Black | Bianco/White | Pg. 62-63 |
| 71727 | Nero/Black | Nero/Black | Pg. 62-63 |
| 71728 | Nero/Black | Silver | Pg. 62-63 |

REGOLAZIONI ADJUSTABILITY



DEEP_EVO STD

| CODE | FINISHING BODY | FINISHING REFLECTOR | MODULI |
|-------|----------------|---------------------|-----------|
| 71600 | Bianco/White | Bianco/White | Pg. 62-63 |
| 71601 | Bianco/White | Nero/Black | Pg. 62-63 |
| 71602 | Bianco/White | Silver | Pg. 62-63 |
| 71603 | Nero/Black | Bianco/White | Pg. 62-63 |
| 71604 | Nero/Black | Nero/Black | Pg. 62-63 |
| 71605 | Nero/Black | Silver | Pg. 62-63 |

INSTALLAZIONE APPLICATION



Incasso/
Recessed

DISEGNI TECNICI C/ MODULO LED TECHNICAL DRAWING W/ LED MODULE

LED Module 20W-24W

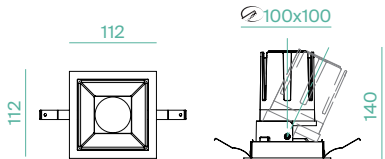

INSTALLAZIONE APPLICATION



Incasso/
Recessed

DISEGNI TECNICI C/ MODULO LED TECHNICAL DRAWING W/ LED MODULE

LED Module 9W

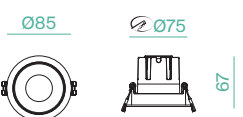

LED Module 12W-15W

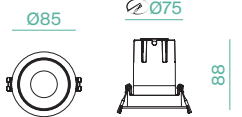



MODULO LED DEEP_EVO

LED
CRI
PF

Bridgelux
>90
>0.9

| CODE | WATT | LUMEN | BEAM | KELVIN | DRIVER | MODE |
|-------|------|-------|------|--------|--------------|--------|
| 71606 | 9W | 715 | 15° | 3000K | 30-42V 200mA | ON-OFF |
| 71607 | 9W | 725 | 24° | 3000K | 30-42V 200mA | ON-OFF |
| 71608 | 9W | 710 | 38° | 3000K | 30-42V 200mA | ON-OFF |
| 71609 | 9W | 695 | 55° | 3000K | 30-42V 200mA | ON-OFF |
| 71610 | 12W | 1015 | 15° | 3000K | 30-42V 300mA | ON-OFF |
| 71611 | 12W | 1055 | 24° | 3000K | 30-42V 300mA | ON-OFF |
| 71612 | 12W | 1050 | 38° | 3000K | 30-42V 300mA | ON-OFF |
| 71613 | 12W | 1000 | 55° | 3000K | 30-42V 300mA | ON-OFF |
| 71614 | 15W | 1150 | 15° | 3000K | 30-42V 350mA | ON-OFF |
| 71615 | 15W | 1170 | 24° | 3000K | 30-42V 350mA | ON-OFF |
| 71616 | 15W | 1155 | 38° | 3000K | 30-42V 350mA | ON-OFF |
| 71617 | 15W | 1110 | 55° | 3000K | 30-42V 350mA | ON-OFF |
| 71747 | 20W | 1863 | 18° | 3000K | 40V 500mA | ON-OFF |
| 71748 | 20W | 1948 | 24° | 3000K | 40V 500mA | ON-OFF |
| 71749 | 20W | 1909 | 35° | 3000K | 40V 500mA | ON-OFF |
| 71750 | 20W | 1873 | 50° | 3000K | 40V 500mA | ON-OFF |
| 71751 | 24W | 2321 | 18° | 3000K | 40V 600mA | ON-OFF |
| 71752 | 24W | 2314 | 24° | 3000K | 40V 600mA | ON-OFF |
| 71753 | 24W | 2307 | 35° | 3000K | 40V 600mA | ON-OFF |
| 71754 | 24W | 2301 | 50° | 3000K | 40V 600mA | ON-OFF |
| 71618 | 9W | 715 | 15° | 3000K | 30-42V 200mA | 1-10V |
| 71619 | 9W | 725 | 24° | 3000K | 30-42V 200mA | 1-10V |
| 71620 | 9W | 710 | 38° | 3000K | 30-42V 200mA | 1-10V |
| 71621 | 9W | 695 | 55° | 3000K | 30-42V 200mA | 1-10V |
| 71622 | 12W | 1015 | 15° | 3000K | 30-42V 300mA | 1-10V |
| 71623 | 12W | 1055 | 24° | 3000K | 30-42V 300mA | 1-10V |
| 71624 | 12W | 1050 | 38° | 3000K | 30-42V 300mA | 1-10V |
| 71625 | 12W | 1000 | 55° | 3000K | 30-42V 300mA | 1-10V |
| 71626 | 15W | 1150 | 15° | 3000K | 30-42V 350mA | 1-10V |
| 71627 | 15W | 1170 | 24° | 3000K | 30-42V 350mA | 1-10V |
| 71628 | 15W | 1155 | 38° | 3000K | 30-42V 350mA | 1-10V |
| 71629 | 15W | 1110 | 55° | 3000K | 30-42V 350mA | 1-10V |

MODULO LED DEEP_EVO

| CODE | WATT | LUMEN | BEAM | KELVIN | DRIVER | MODE |
|-------|------|-------|------|--------|--------------|-----------|
| 71763 | 9W | 715 | 15° | 3000K | 30-42V 200mA | DALI/PUSH |
| 71764 | 9W | 725 | 24° | 3000K | 30-42V 200mA | DALI/PUSH |
| 71765 | 9W | 710 | 38° | 3000K | 30-42V 200mA | DALI/PUSH |
| 71766 | 9W | 695 | 55° | 3000K | 30-42V 200mA | DALI/PUSH |
| 71767 | 12W | 1015 | 15° | 3000K | 30-42V 300mA | DALI/PUSH |
| 71768 | 12W | 1055 | 24° | 3000K | 30-42V 300mA | DALI/PUSH |
| 71769 | 12W | 1050 | 38° | 3000K | 30-42V 300mA | DALI/PUSH |
| 71770 | 12W | 1000 | 55° | 3000K | 30-42V 300mA | DALI/PUSH |
| 71771 | 15W | 1150 | 15° | 3000K | 30-42V 350mA | DALI/PUSH |
| 71772 | 15W | 1170 | 24° | 3000K | 30-42V 350mA | DALI/PUSH |
| 71773 | 15W | 1155 | 38° | 3000K | 30-42V 350mA | DALI/PUSH |
| 71774 | 15W | 1110 | 55° | 3000K | 30-42V 350mA | DALI/PUSH |
| 71755 | 20W | 1863 | 18° | 3000K | 40V 500mA | DALI/PUSH |
| 71756 | 20W | 1948 | 24° | 3000K | 40V 500mA | DALI/PUSH |
| 71757 | 20W | 1909 | 35° | 3000K | 40V 500mA | DALI/PUSH |
| 71758 | 20W | 1873 | 50° | 3000K | 40V 500mA | DALI/PUSH |
| 71759 | 24W | 2321 | 18° | 3000K | 40V 600mA | DALI/PUSH |
| 71760 | 24W | 2314 | 24° | 3000K | 40V 600mA | DALI/PUSH |
| 71761 | 24W | 2307 | 35° | 3000K | 40V 600mA | DALI/PUSH |
| 71762 | 24W | 2301 | 50° | 3000K | 40V 600mA | DALI/PUSH |

ACCESSORI ACCESSORIES



| CODE | DESCRIPTION |
|-------|--|
| 71575 | Filtro honeycomb 9W-12W-15W /Honeycomb filter 9W-12W-15W |
| 71663 | Filtro honeycomb 20W-24W/Honeycomb filter 20W-24W |



Fulgor è la sintesi perfetta di design e funzionalità. Questo proiettore a binario di alta qualità, caratterizzato da forme minimali e una fattura impeccabile, è disponibile in tre dimensioni e in due varianti, a soffitto e a incasso, per garantire una grande versatilità di applicazioni. Grazie alla sua perfetta integrazione nell'ambiente circostante, Fulgor offre una luce diretta precisa e controllata, illuminando con stile ogni spazio in cui viene installato.

FULGOR is the perfect synthesis of design and functionality. This high quality track fitting, characterized by minimalistic shapes and impeccable manufacture, is available in three different dimensions. Thanks to its perfect integration into any environment, FULGOR guarantees a precise and controlled light effect providing a stylish solution to any installation.





FULGOR 15W

LED
CRI
PF

Bridgelux
>90
0.9

| CODE | FINISHING | WATT | LUMEN | WATT LIGHT SOURCE | LUMEN LIGHT SOURCE | BEAM | KELVIN | DRIVER |
|-------|--------------|------|-------|-------------------|--------------------|------|--------|--------------|
| 41797 | Bianco/White | 15W | 1560 | 14,8W | 1710 | 15° | 3000K | 36-38V 350mA |
| 41811 | Nero/Black | 15W | 1560 | 14,8W | 1710 | 15° | 3000K | 36-38V 350mA |
| 41804 | Bianco/White | 15W | 1557 | 14,8W | 1834 | 15° | 4000K | 36-38V 350mA |
| 41818 | Nero/Black | 15W | 1557 | 14,8W | 1834 | 15° | 4000K | 36-38V 350mA |
| 41798 | Bianco/White | 15W | 1574 | 14,8W | 1710 | 24° | 3000K | 36-38V 350mA |
| 41812 | Nero/Black | 15W | 1574 | 14,8W | 1710 | 24° | 3000K | 36-38V 350mA |
| 41805 | Bianco/White | 15W | 1584 | 14,8W | 1834 | 24° | 4000K | 36-38V 350mA |
| 41819 | Nero/Black | 15W | 1584 | 14,8W | 1834 | 24° | 4000K | 36-38V 350mA |
| 41799 | Bianco/White | 15W | 1591 | 14,8W | 1710 | 38° | 3000K | 36-38V 350mA |
| 41813 | Nero/Black | 15W | 1591 | 14,8W | 1710 | 38° | 3000K | 36-38V 350mA |
| 41806 | Bianco/White | 15W | 1585 | 14,8W | 1834 | 38° | 4000K | 36-38V 350mA |
| 41820 | Nero/Black | 15W | 1585 | 14,8W | 1834 | 38° | 4000K | 36-38V 350mA |
| 41800 | Bianco/White | 15W | 1509 | 14,8W | 1710 | 55° | 3000K | 36-38V 350mA |
| 41814 | Nero/Black | 15W | 1509 | 14,8W | 1710 | 55° | 3000K | 36-38V 350mA |
| 41807 | Bianco/White | 15W | 1531 | 14,8W | 1834 | 55° | 4000K | 36-38V 350mA |
| 41821 | Nero/Black | 15W | 1531 | 14,8W | 1834 | 55° | 4000K | 36-38V 350mA |

INSTALLAZIONE APPLICATION



DISEGNI TECNICI TECHNICAL DRAWINGS

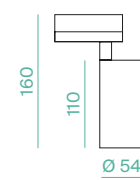

REGOLAZIONI ADJUSTABILITY



FULGOR 15W DALI-PUSH

LED
CRI
PF

Bridgelux
>90
0.9

| CODE | FINISHING | WATT | LUMEN | WATT LIGHT SOURCE | LUMEN LIGHT SOURCE | BEAM | KELVIN | DRIVER |
|-------|--------------|------|-------|-------------------|--------------------|------|--------|--------------|
| 41825 | Bianco/White | 15W | 1560 | 14,8W | 1710 | 15° | 3000K | 36-38V 350mA |
| 41847 | Nero/Black | 15W | 1560 | 14,8W | 1710 | 15° | 3000K | 36-38V 350mA |
| 41836 | Bianco/White | 15W | 1557 | 14,8W | 1834 | 15° | 4000K | 36-38V 350mA |
| 41858 | Nero/Black | 15W | 1557 | 14,8W | 1834 | 15° | 4000K | 36-38V 350mA |
| 41826 | Bianco/White | 15W | 1574 | 14,8W | 1710 | 24° | 3000K | 36-38V 350mA |
| 41848 | Nero/Black | 15W | 1574 | 14,8W | 1710 | 24° | 3000K | 36-38V 350mA |
| 41837 | Bianco/White | 15W | 1584 | 14,8W | 1834 | 24° | 4000K | 36-38V 350mA |
| 41859 | Nero/Black | 15W | 1584 | 14,8W | 1834 | 24° | 4000K | 36-38V 350mA |
| 41827 | Bianco/White | 15W | 1591 | 14,8W | 1710 | 38° | 3000K | 36-38V 350mA |
| 41849 | Nero/Black | 15W | 1591 | 14,8W | 1710 | 38° | 3000K | 36-38V 350mA |
| 41838 | Bianco/White | 15W | 1585 | 14,8W | 1834 | 38° | 4000K | 36-38V 350mA |
| 41860 | Nero/Black | 15W | 1585 | 14,8W | 1834 | 38° | 4000K | 36-38V 350mA |
| 41828 | Bianco/White | 15W | 1509 | 14,8W | 1710 | 55° | 3000K | 36-38V 350mA |
| 41850 | Nero/Black | 15W | 1509 | 14,8W | 1710 | 55° | 3000K | 36-38V 350mA |
| 41839 | Bianco/White | 15W | 1531 | 14,8W | 1834 | 55° | 4000K | 36-38V 350mA |
| 41861 | Nero/Black | 15W | 1531 | 14,8W | 1834 | 55° | 4000K | 36-38V 350mA |

INSTALLAZIONE APPLICATION



DISEGNI TECNICI TECHNICAL DRAWINGS

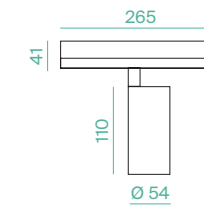

REGOLAZIONI ADJUSTABILITY



ACCESSORI ACCESSORIES

| CODE | DESCRIPTION |
|-------|---|
| 71575 | Filtro honeycomb 15W/Honeycomb filter 15W |



ACCESSORI ACCESSORIES

| CODE | DESCRIPTION |
|-------|---|
| 71575 | Filtro honeycomb 15W/Honeycomb filter 15W |





FULGOR 24W

LED
CRI
PF

Bridgelux
>90
0.9

| CODE | FINISHING | WATT | LUMEN | WATT LIGHT SOURCE | LUMEN LIGHT SOURCE | BEAM | KELVIN | DRIVER |
|-------|--------------|------|-------|-------------------|--------------------|------|--------|--------------|
| 41678 | Bianco/White | 24W | 2220 | 24W | 2640 | 15° | 3000K | 36-38V 600mA |
| 41679 | Nero/Black | 24W | 2220 | 24W | 2640 | 15° | 3000K | 36-38V 600mA |
| 41680 | Bianco/White | 24W | 2400 | 24W | 2880 | 15° | 4000K | 36-38V 600mA |
| 41681 | Nero/Black | 24W | 2400 | 24W | 2880 | 15° | 4000K | 36-38V 600mA |
| 41674 | Bianco/White | 24W | 2280 | 24W | 2640 | 24° | 3000K | 36-38V 600mA |
| 41675 | Nero/Black | 24W | 2280 | 24W | 2640 | 24° | 3000K | 36-38V 600mA |
| 41676 | Bianco/White | 24W | 2480 | 24W | 2880 | 24° | 4000K | 36-38V 600mA |
| 41677 | Nero/Black | 24W | 2480 | 24W | 2880 | 24° | 4000K | 36-38V 600mA |
| 41670 | Bianco/White | 24W | 2340 | 24W | 2640 | 38° | 3000K | 36-38V 600mA |
| 41671 | Nero/Black | 24W | 2340 | 24W | 2640 | 38° | 3000K | 36-38V 600mA |
| 41672 | Bianco/White | 24W | 2550 | 24W | 2880 | 38° | 4000K | 36-38V 600mA |
| 41673 | Nero/Black | 24W | 2550 | 24W | 2880 | 38° | 4000K | 36-38V 600mA |
| 41666 | Bianco/White | 24W | 2310 | 24W | 2640 | 55° | 3000K | 36-38V 600mA |
| 41668 | Nero/Black | 24W | 2310 | 24W | 2640 | 55° | 3000K | 36-38V 600mA |
| 41667 | Bianco/White | 24W | 2510 | 24W | 2880 | 55° | 4000K | 36-38V 600mA |
| 41669 | Nero/Black | 24W | 2510 | 24W | 2880 | 55° | 4000K | 36-38V 600mA |

INSTALLAZIONE APPLICATION

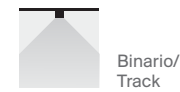

DISEGNI TECNICI TECHNICAL DRAWINGS

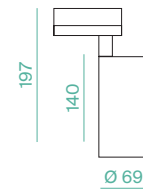

REGOLAZIONI ADJUSTABILITY



FULGOR 24W DALI-PUSH

LED
CRI
PF

Bridgelux
>90
0.9

| CODE | FINISHING | WATT | LUMEN | WATT LIGHT SOURCE | LUMEN LIGHT SOURCE | BEAM | KELVIN | DRIVER |
|-------|--------------|------|-------|-------------------|--------------------|------|--------|--------------|
| 41829 | Bianco/White | 24W | 2220 | 24W | 2640 | 15° | 3000K | 36-38V 600mA |
| 41851 | Nero/Black | 24W | 2220 | 24W | 2640 | 15° | 3000K | 36-38V 600mA |
| 41840 | Bianco/White | 24W | 2400 | 24W | 2880 | 15° | 4000K | 36-38V 600mA |
| 41862 | Nero/Black | 24W | 2400 | 24W | 2880 | 15° | 4000K | 36-38V 600mA |
| 41830 | Bianco/White | 24W | 2280 | 24W | 2640 | 24° | 3000K | 36-38V 600mA |
| 41852 | Nero/Black | 24W | 2280 | 24W | 2640 | 24° | 3000K | 36-38V 600mA |
| 41841 | Bianco/White | 24W | 2480 | 24W | 2880 | 24° | 4000K | 36-38V 600mA |
| 41863 | Nero/Black | 24W | 2480 | 24W | 2880 | 24° | 4000K | 36-38V 600mA |
| 41831 | Bianco/White | 24W | 2340 | 24W | 2640 | 38° | 3000K | 36-38V 600mA |
| 41853 | Nero/Black | 24W | 2340 | 24W | 2640 | 38° | 3000K | 36-38V 600mA |
| 41842 | Bianco/White | 24W | 2550 | 24W | 2880 | 38° | 4000K | 36-38V 600mA |
| 41864 | Nero/Black | 24W | 2550 | 24W | 2880 | 38° | 4000K | 36-38V 600mA |
| 41832 | Bianco/White | 24W | 2310 | 24W | 2640 | 55° | 3000K | 36-38V 600mA |
| 41854 | Nero/Black | 24W | 2310 | 24W | 2640 | 55° | 3000K | 36-38V 600mA |
| 41843 | Bianco/White | 24W | 2510 | 24W | 2880 | 55° | 4000K | 36-38V 600mA |
| 41865 | Nero/Black | 24W | 2510 | 24W | 2880 | 55° | 4000K | 36-38V 600mA |

INSTALLAZIONE APPLICATION



DISEGNI TECNICI TECHNICAL DRAWINGS

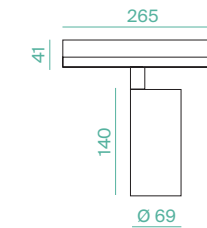

REGOLAZIONI ADJUSTABILITY



ACCESSORI ACCESSORIES

| CODE | DESCRIPTION |
|-------|---|
| 71663 | Filtro honeycomb 24W/Honeycomb filter 24W |



ACCESSORI ACCESSORIES

| CODE | DESCRIPTION |
|-------|---|
| 71663 | Filtro honeycomb 24W/Honeycomb filter 24W |





FULGOR 35W

LED
CRI
PF

Bridgelux
>90
0.9

| CODE | FINISHING | WATT | LUMEN | WATT LIGHT SOURCE | LUMEN LIGHT SOURCE | BEAM | KELVIN | DRIVER |
|-------|--------------|------|-------|-------------------|--------------------|------|--------|--------------|
| 41801 | Bianco/White | 35W | 3267 | 33,5W | 3705 | 15° | 3000K | 36-38V 850mA |
| 41815 | Nero/Black | 35W | 3267 | 33,5W | 3705 | 15° | 3000K | 36-38V 850mA |
| 41808 | Bianco/White | 35W | 3405 | 33,5W | 3973 | 15° | 4000K | 36-38V 850mA |
| 41822 | Nero/Black | 35W | 3405 | 33,5W | 3973 | 15° | 4000K | 36-38V 850mA |
| 41802 | Bianco/White | 35W | 3408 | 33,5W | 3705 | 24° | 3000K | 36-38V 850mA |
| 41816 | Nero/Black | 35W | 3408 | 33,5W | 3705 | 24° | 3000K | 36-38V 850mA |
| 41809 | Bianco/White | 35W | 3462 | 33,5W | 3973 | 24° | 4000K | 36-38V 850mA |
| 41823 | Nero/Black | 35W | 3462 | 33,5W | 3973 | 24° | 4000K | 36-38V 850mA |
| 41803 | Bianco/White | 35W | 3370 | 33,5W | 3705 | 38° | 3000K | 36-38V 850mA |
| 41817 | Nero/Black | 35W | 3370 | 33,5W | 3705 | 38° | 3000K | 36-38V 850mA |
| 41810 | Bianco/White | 35W | 3483 | 33,5W | 3973 | 38° | 4000K | 36-38V 850mA |
| 41824 | Nero/Black | 35W | 3483 | 33,5W | 3973 | 38° | 4000K | 36-38V 850mA |

INSTALLAZIONE APPLICATION



DISEGNI TECNICI TECHNICAL DRAWINGS

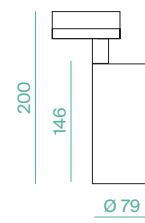

REGOLAZIONI ADJUSTABILITY



FULGOR 35W DALI-PUSH

LED
CRI
PF

Bridgelux
>90
0.9

| CODE | FINISHING | WATT | LUMEN | WATT LIGHT SOURCE | LUMEN LIGHT SOURCE | BEAM | KELVIN | DRIVER |
|-------|--------------|------|-------|-------------------|--------------------|------|--------|--------------|
| 41833 | Bianco/White | 35W | 3267 | 33,5W | 3705 | 15° | 3000K | 36-38V 850mA |
| 41855 | Nero/Black | 35W | 3267 | 33,5W | 3705 | 15° | 3000K | 36-38V 850mA |
| 41844 | Bianco/White | 35W | 3405 | 33,5W | 3973 | 15° | 4000K | 36-38V 850mA |
| 41866 | Nero/Black | 35W | 3405 | 33,5W | 3973 | 15° | 4000K | 36-38V 850mA |
| 41834 | Bianco/White | 35W | 3408 | 33,5W | 3705 | 24° | 3000K | 36-38V 850mA |
| 41856 | Nero/Black | 35W | 3408 | 33,5W | 3705 | 24° | 3000K | 36-38V 850mA |
| 41845 | Bianco/White | 35W | 3462 | 33,5W | 3973 | 24° | 4000K | 36-38V 850mA |
| 41867 | Nero/Black | 35W | 3462 | 33,5W | 3973 | 24° | 4000K | 36-38V 850mA |
| 41835 | Bianco/White | 35W | 3370 | 33,5W | 3705 | 38° | 3000K | 36-38V 850mA |
| 41857 | Nero/Black | 35W | 3370 | 33,5W | 3705 | 38° | 3000K | 36-38V 850mA |
| 41846 | Bianco/White | 35W | 3483 | 33,5W | 3973 | 38° | 4000K | 36-38V 850mA |
| 41868 | Nero/Black | 35W | 3483 | 33,5W | 3973 | 38° | 4000K | 36-38V 850mA |

INSTALLAZIONE APPLICATION



DISEGNI TECNICI TECHNICAL DRAWINGS

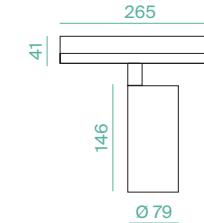

REGOLAZIONI ADJUSTABILITY



ACCESSORI ACCESSORIES

| CODE | DESCRIPTION |
|-------|---|
| 71664 | Filtro honeycomb 35W/Honeycomb filter 35W |



ACCESSORI ACCESSORIES

| CODE | DESCRIPTION |
|-------|---|
| 71664 | Filtro honeycomb 35W/Honeycomb filter 35W |





FULGOR SOFFITTO/PARETE

LED
CRI
PF

Bridgelux
>90
0.9

| CODE | FINISHING | WATT | LUMEN | WATT LIGHT SOURCE | LUMEN LIGHT SOURCE | BEAM | KELVIN | DRIVER |
|-------|--------------|------|-------|-------------------|--------------------|------|--------|--------------|
| 41869 | Bianco/White | 15W | 1560 | 14,8W | 1710 | 15° | 3000K | 36-38V 350mA |
| 41877 | Nero/Black | 15W | 1560 | 14,8W | 1710 | 15° | 3000K | 36-38V 350mA |
| 41873 | Bianco/White | 15W | 1557 | 14,8W | 1834 | 15° | 4000K | 36-38V 350mA |
| 41881 | Nero/Black | 15W | 1557 | 14,8W | 1834 | 15° | 4000K | 36-38V 350mA |
| 41870 | Bianco/White | 15W | 1574 | 14,8W | 1710 | 24° | 3000K | 36-38V 350mA |
| 41878 | Nero/Black | 15W | 1574 | 14,8W | 1710 | 24° | 3000K | 36-38V 350mA |
| 41874 | Bianco/White | 15W | 1584 | 14,8W | 1834 | 24° | 4000K | 36-38V 350mA |
| 41882 | Nero/Black | 15W | 1584 | 14,8W | 1834 | 24° | 4000K | 36-38V 350mA |
| 41871 | Bianco/White | 15W | 1591 | 14,8W | 1710 | 38° | 3000K | 36-38V 350mA |
| 41879 | Nero/Black | 15W | 1591 | 14,8W | 1710 | 38° | 3000K | 36-38V 350mA |
| 41875 | Bianco/White | 15W | 1585 | 14,8W | 1834 | 38° | 4000K | 36-38V 350mA |
| 41883 | Nero/Black | 15W | 1585 | 14,8W | 1834 | 38° | 4000K | 36-38V 350mA |
| 41872 | Bianco/White | 15W | 1509 | 14,8W | 1710 | 55° | 3000K | 36-38V 350mA |
| 41880 | Nero/Black | 15W | 1509 | 14,8W | 1710 | 55° | 3000K | 36-38V 350mA |
| 41876 | Bianco/White | 15W | 1531 | 14,8W | 1834 | 55° | 4000K | 36-38V 350mA |
| 41884 | Nero/Black | 15W | 1531 | 14,8W | 1834 | 55° | 4000K | 36-38V 350mA |

INSTALLAZIONE APPLICATION



DISEGNI TECNICI TECHNICAL DRAWINGS

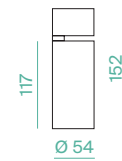

REGOLAZIONI ADJUSTABILITY



FULGOR_IN INCASSO

LED
CRI
PF

Bridgelux
>90
>0.95

| CODE | FINISHING | WATT | LUMEN | WATT LIGHT SOURCE | LUMEN LIGHT SOURCE | BEAM | KELVIN | DRIVER |
|-------|--------------|------|-------|-------------------|--------------------|------|--------|--------------|
| 41686 | Bianco/White | 24W | 2220 | 24W | 2640 | 15° | 3000K | 30-42V 600mA |
| 41688 | Nero/Black | 24W | 2220 | 24W | 2640 | 15° | 3000K | 30-42V 600mA |
| 41687 | Bianco/White | 24W | 2400 | 24W | 2880 | 15° | 4000K | 30-42V 600mA |
| 41689 | Nero/Black | 24W | 2400 | 24W | 2880 | 15° | 4000K | 30-42V 600mA |
| 41690 | Bianco/White | 24W | 2280 | 24W | 2640 | 24° | 3000K | 30-42V 600mA |
| 41692 | Nero/Black | 24W | 2280 | 24W | 2640 | 24° | 3000K | 30-42V 600mA |
| 41691 | Bianco/White | 24W | 2480 | 24W | 2880 | 24° | 4000K | 30-42V 600mA |
| 41693 | Nero/Black | 24W | 2480 | 24W | 2880 | 24° | 4000K | 30-42V 600mA |
| 41682 | Bianco/White | 24W | 2340 | 24W | 2640 | 38° | 3000K | 30-42V 600mA |
| 41684 | Nero/Black | 24W | 2340 | 24W | 2640 | 38° | 3000K | 30-42V 600mA |
| 41683 | Bianco/White | 24W | 2550 | 24W | 2880 | 38° | 4000K | 30-42V 600mA |
| 41685 | Nero/Black | 24W | 2550 | 24W | 2880 | 38° | 4000K | 30-42V 600mA |
| 41694 | Bianco/White | 24W | 2310 | 24W | 2640 | 55° | 3000K | 30-42V 600mA |
| 41696 | Nero/Black | 24W | 2310 | 24W | 2640 | 55° | 3000K | 30-42V 600mA |
| 41695 | Bianco/White | 24W | 2510 | 24W | 2880 | 55° | 4000K | 30-42V 600mA |
| 41697 | Nero/Black | 24W | 2510 | 24W | 2880 | 55° | 4000K | 30-42V 600mA |

INSTALLAZIONE APPLICATION



DISEGNI TECNICI TECHNICAL DRAWINGS

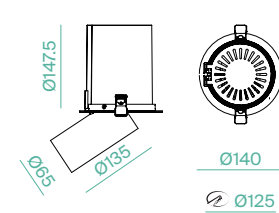

REGOLAZIONI ADJUSTABILITY

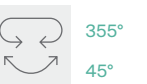

ACCESSORI ACCESSORIES

| CODE | DESCRIPTION |
|-------|---|
| 71575 | Filtro honeycomb 15W/Honeycomb filter 15W |



ACCESSORI ACCESSORIES

| CODE | DESCRIPTION |
|-------|---|
| 71663 | Filtro honeycomb 24W/Honeycomb filter 24W |



Incasso funzionale in alluminio con ottica in polimero che combina un'ottima dissipazione del calore e un accurato controllo della luce. Controllo del flicker-free sul driver e accurata gestione della componente blu del LED per assicurare il miglior comfort visivo. CCT selezionabile 3000/4000°K con mantenimento dell'efficienza luminosa. CRI >90 e grado di protezione IP54 frontale. Ampia gamma di potenze per illuminamenti da 1234lm a 3569lm.

Functional aluminium recessed fitting with optical polymer reflector which combines an excellent heat sink with an accurate light control. Flicker-free separate control gear and Low Blue light technology guarantee an excellent visual comfort. Selectable CCT (3000/4000°K) maintaining the luminous efficacy unaltered. CRI>90 and IP54 frontal protection. Wide choice of powers available with lumen output ranging from 1234 to 3569



Efficienza da incasso

Recessed efficiency

Il riflettore incassato in polimeri ottici fornisce un'illuminazione omogenea, con un grado di abbagliamento luminoso certificato UGR<19 che assicura la qualità della luce ed il benessere delle persone nel contesto lavorativo.

The deep-set aluminium reflector made of optical polymer ensures an efficient and homogeneous light with high glare control certified UGR < 19 which provides quality of light and consequently the well-being of people in their working spaces.

La resa cromatica CRI>90 garantisce che il tipo di luce emessa rispecchi i colori naturali di ambienti, oggetti o persone.

The high Colour Rendering Index CRI>90 means that the light emitted guarantees the natural rendering of colours of rooms, objects and people.

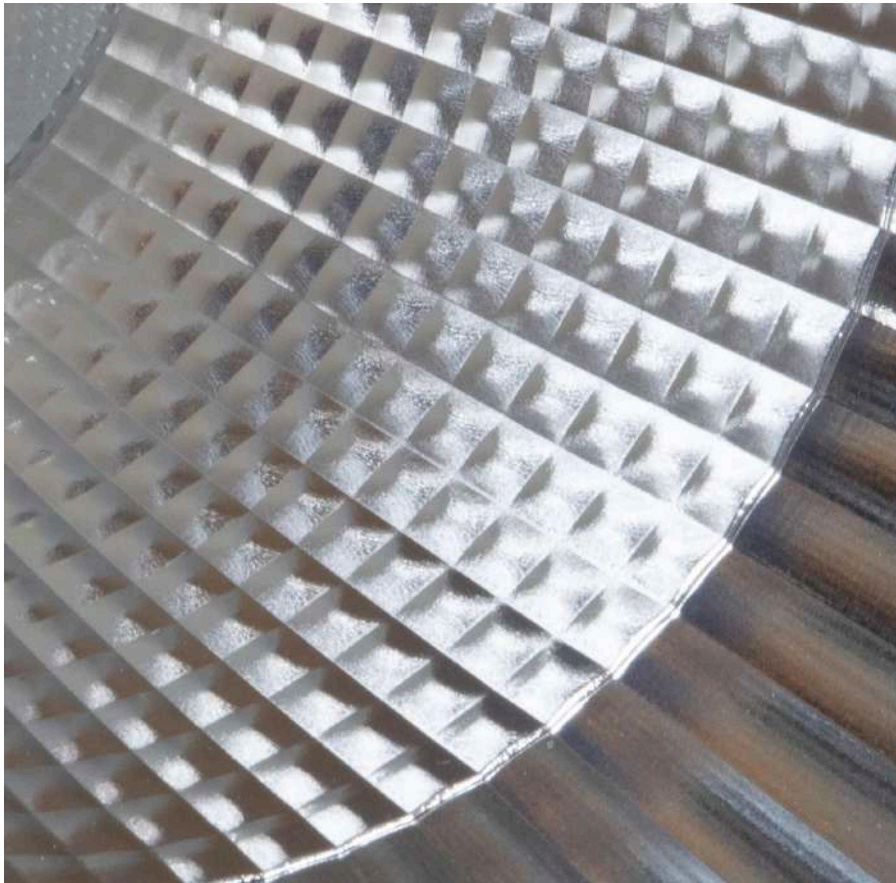

L80B20_50000 ore

L80B20_50000 hours

T° COLORE 3000/4000K
 Selezione della temperatura di colore mediante interruttore sul corpo, mantenendo l'efficienza luminosa di ca. 110lm/W.

COLOR TEMPERATURE 3000/4000K
 Selection of the T° Color Temperature through a switch mounted on the body, maintaining the luminous efficacy at approx 110lm/W unaltered.

IP54
 L'apparecchio è protetto nella parte frontale contro la polvere e gli spruzzi d'acqua rispettando eventuali normative richieste.

IP54
 The fitting is protected at the front from dust and water spray complying with eventual IP standards required.

CABLAGGIO SEMPLICE
 Le dimensioni dell'apparecchio lo rendono ideale per il relamping e gli spinotti Amp rendono facile e veloce il cablaggio.

EASY WIRING
 The downlight dimensions make it an ideal choice as a retrofit fitting and the Plug-in connection makes wiring easy and fast.

DIMMER-ON/OFF/DALI
 Possibilità di connessione ad un driver esterno con gestione ON/OFF o TRIAC o DALI.

DIMMER-ON/OFF/DALI
 Several separate control gears available: ON/OFF or TRIAC or DALI.

BELLATRIX

LED OSRAM
 CRI >90
 PF >0.9
 UGR <19



| CODE | FINISHING | WATT | LUMEN | BEAM | KELVIN |
|-------|--------------|-------|-----------|------|-------------|
| 51011 | Bianco/White | 10,8W | 1234/1278 | 55° | 3000K/4000K |
| 51012 | Bianco/White | 16,2W | 1712/1779 | 55° | 3000K/4000K |
| 51013 | Bianco/White | 21,6W | 2430/2500 | 55° | 3000K/4000K |
| 51014 | Bianco/White | 27W | 2961/3140 | 55° | 3000K/4000K |
| 51015 | Bianco/White | 32,4W | 3357/3569 | 55° | 3000K/4000K |

INSTALLAZIONE APPLICATION



DISEGNI TECNICI TECHNICAL DRAWINGS

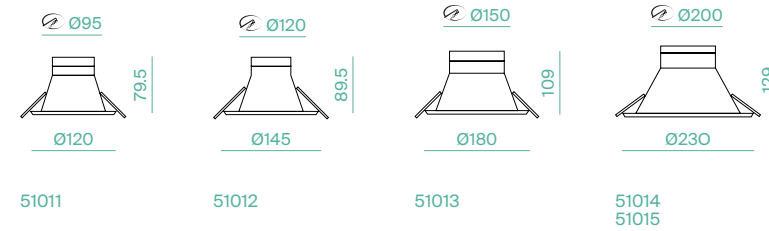

DRIVER

| CODE | DESCRIPTION |
|-------|--|
| 51016 | Driver ON/OFF 12W (10,8W) / 36V DC / 300mA |
| 51017 | Driver ON/OFF 18W (16,2W) / 36V DC / 450mA |
| 51018 | Driver ON/OFF 23W (21,6 W) / 36V DC / 600mA |
| 51019 | Driver ON/OFF 28W (27W) / 36V DC / 750mA |
| 51020 | Driver ON/OFF 35W (32,4W) / 36V DC / 900mA |
| 51021 | Driver TRIAC Dimming 12W (10,8W) / 36V DC / 300mA |
| 51022 | Driver TRIAC Dimming 18W (16,2W) / 36V DC / 450mA |
| 51023 | Driver TRIAC Dimming 23W (21,6W) / 36V DC / 600mA |
| 51024 | Driver TRIAC Dimming 28W (27W) / 36V DC / 750mA |
| 51025 | Driver TRIAC Dimming 35W (32,4W) / 36V DC / 900mA |
| 51026 | Driver DALI 2 12W (10,8W) / 36V DC / 300mA |
| 51027 | Driver DALI 2 18W/23W (16,2W/21,6W) / 36V DC / 450-600mA |
| 51028 | Driver DALI 2 28W/35W (27W/32,4W) / 36V DC / 750-900mA |



Marino Cristal S.p.A.

Via Guardia del Consiglio, 31
47899 Serravalle
Rep. di San Marino

Tel. (+378) 0549 901188

Fax (+378) 0549 900612

www.logicailluminazione.com

info@logicailluminazione.com

LOGICA

Logica è un marchio
di Marino Cristal S.p.A.

Marino Cristal S.p.A.

Via Guardia del Consiglio 31
47899 Serravalle
Rep. di San Marino

Tel. (+378) 0549 901188
Fax (+378) 0549 900612

www.logicailuminazione.com
info@logicailuminazione.com