

LOGICA

Catalistino
2023

**LOGICA
Catalistino
2023**

INDICE VISIVO

STREAMLIGHT SYSTEM



Streamlight
System

6



Streamlight
Incasso

8



Streamlight

9

MAGNETIC SYSTEM



Klik Klak

10



Klik Klak
Mini

20

TRACK SPOTLIGHTS



Fulgor

30



Unico Dicro

36



Unico AR111

36

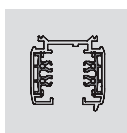

Tracks
Tracks incasso
+ Accessori

37 + 38



Emergenza

41

DOWNLIGHTS



Deep_EVO

42



Deep_EVO
LESS

43



Deep_EVO
GU10

44



Deep_EVO
LESS GU10

45



Deep_EVO
GRANDE

46



Deep_EVO
LESS
GRANDE

47

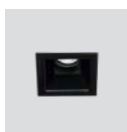

Deep_EVO_Q

48

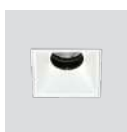

Deep_EVO
LESS_Q



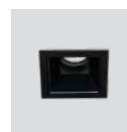









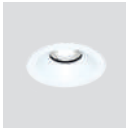

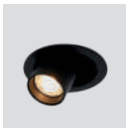

48

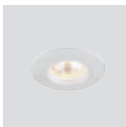
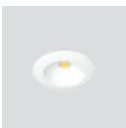



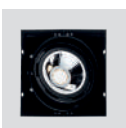
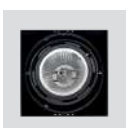
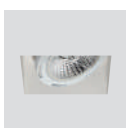
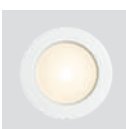

Deep_EVO_Q
GU10

49

DOWNLIGHTS

	Deep_EVO LESS_Q GU10 49		Deep_EVO_Q GRANDE 50		Deep_EVO STD 51
	MODULI 52		Fulgor_IN 54		Bellatrix 55
	Punto 56		Punto L 57		Occhio 58
	Mini 59		Zeus 62		Aqua_COB 63
	Aqua_SMD 63		Frame 64		Frame 111 65
	Frameless 67		Frameless 111 68		Wizard 70
	Deep c/vetro 71		Deep Zero 72		Deep 73

RECHARGEABLE

	Zen 74		lota 75		Diogene 76
	Diogene Hybrid 78		Twiggy_LESS 80		

CEILING LIGHTS



A+B

81



Fulgor

82



Unico Dicro

83

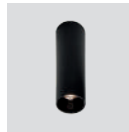

Cyl

83



Altair

84



Box Dicro

85



Box 111

85



Container

86



Container 111

87

SUSPENSION LIGHTS



A+B

89



Shanghai

90



Cyl

92

WALL LIGHTS



Fulgor

82



Unico Dicro

83

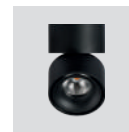

Altair

84



Minima

93



Dumbo

94



Bloc

95

PROFILES



Wall

96



Onda

97



Line_EVO

98

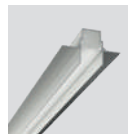

Line DEEP

100

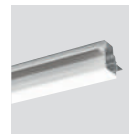

Line

101



Double

102

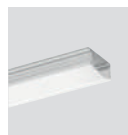

PR1

104



PR1_DEEP

104

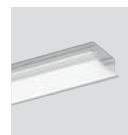

PR2

106



PR2_DEEP

106



PR3_EVO

108

OUTDOOR



Titano EVO

110



Moonlight

114



Fos

116



Combi EVO

117



Dardo

118



Skorpio

119

DRIVER



Driver
+ Emergency

120



STREAMLIGHT SYSTEM

LED
CRI
PF

Samsung
>82
0.9

CODE	FINISHING	WATT	LUMEN	WATT LIGHT SOURCE	LUMEN LIGHT SOURCE	BEAM	KELVIN	DRIVER	KG	PRICE
42654	Bianco/White	27W+3W	2700+300	22.5W+2.5W	3375+375	85°*85°	3000K	ON-OFF 36V-750mA	1,80	233,59
42655	Nero/Black	27W+3W	2700+300	22.5W+2.5W	3375+375	85°*85°	3000K	ON-OFF 36V-750mA	1,80	233,59
42656	Bianco/White	27W+3W	2800+400	22.5W+2.5W	3600+400	85°*85°	4000K	ON-OFF 36V-750mA	1,80	233,59
42657	Nero/Black	27W+3W	2800+400	22.5W+2.5W	3600+400	85°*85°	4000K	ON-OFF 36V-750mA	1,80	233,59
42662	Bianco/White	41W+4W	4300+400	34.2W+3.8W	5310+590	85°*85°	3000K	ON-OFF 36V-1250mA	3,50	378,95
42663	Nero/Black	41W+4W	4300+400	34.2W+3.8W	5310+590	85°*85°	3000K	ON-OFF 36V-1250mA	3,50	378,95
42664	Bianco/White	41W+4W	4500+500	34.2W+3.8W	5625+625	85°*85°	4000K	ON-OFF 36V-1250mA	3,50	378,95
42665	Nero/Black	41W+4W	4500+500	34.2W+3.8W	5625+625	85°*85°	4000K	ON-OFF 36V-1250mA	3,50	378,95
42776	Bianco/White	27W+3W	2700+300	22.5W+2.5W	3375+375	85°*85°	3000K	1-10V 36V-750mA	1,80	283,14
42777	Nero/Black	27W+3W	2700+300	22.5W+2.5W	3375+375	85°*85°	3000K	1-10V 36V-750mA	1,80	283,14
42778	Bianco/White	27W+3W	2800+400	22.5W+2.5W	3600+400	85°*85°	4000K	1-10V 36V-750mA	1,80	283,14
42779	Nero/Black	27W+3W	2800+400	22.5W+2.5W	3600+400	85°*85°	4000K	1-10V 36V-750mA	1,80	283,14
42780	Bianco/White	41W+4W	4300+400	34.2W+3.8W	5310+590	85°*85°	3000K	1-10V 36V-1250mA	3,50	424,73
42781	Nero/Black	41W+4W	4300+400	34.2W+3.8W	5310+590	85°*85°	3000K	1-10V 36V-1250mA	3,50	424,73
42782	Bianco/White	41W+4W	4500+500	34.2W+3.8W	5625+625	85°*85°	4000K	1-10V 36V-1250mA	3,50	424,73
42783	Nero/Black	41W+4W	4500+500	34.2W+3.8W	5625+625	85°*85°	4000K	1-10V 36V-1250mA	3,50	424,73
42658	Bianco/White	27W+3W	2700+300	22.5W+2.5W	3375+375	85°*85°	3000K	DALI 36V-750mA	1,80	322,08
42659	Nero/Black	27W+3W	2700+300	22.5W+2.5W	3375+375	85°*85°	3000K	DALI 36V-750mA	1,80	322,08
42660	Bianco/White	27W+3W	2800+400	22.5W+2.5W	3600+400	85°*85°	4000K	DALI 36V-750mA	1,80	322,08
42661	Nero/Black	27W+3W	2800+400	22.5W+2.5W	3600+400	85°*85°	4000K	DALI 36V-750mA	1,80	322,08
42666	Bianco/White	41W+4W	4300+400	34.2W+3.8W	5310+590	85°*85°	3000K	DALI 36V-1250mA	3,50	473,33
42667	Nero/Black	41W+4W	4300+400	34.2W+3.8W	5310+590	85°*85°	3000K	DALI 36V-1250mA	3,50	473,33
42668	Bianco/White	41W+4W	4500+500	34.2W+3.8W	5625+625	85°*85°	4000K	DALI 36V-1250mA	3,50	473,33
42669	Nero/Black	41W+4W	4500+500	34.2W+3.8W	5625+625	85°*85°	4000K	DALI 36V-1250mA	3,50	473,33

INSTALLAZIONE
APPLICATION

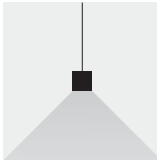

Sospensione/
Suspension



Soffitto/Ceiling

DISEGNI TECNICI
TECHNICAL DRAWINGS

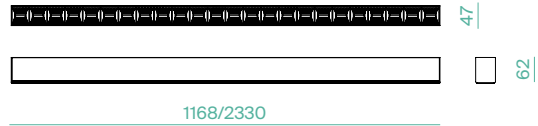

1168/2330

ACCESSORI
ACCESSORIES



42672

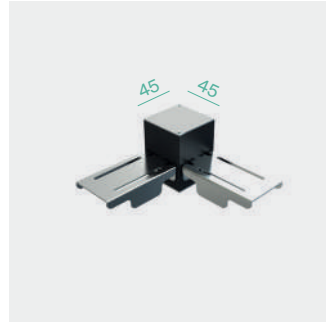

42673 - 42674

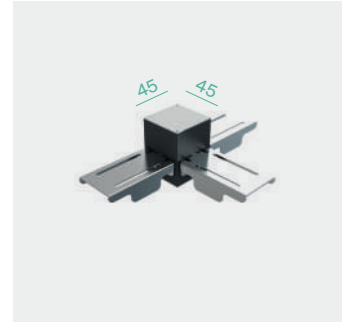

42677 - 42678

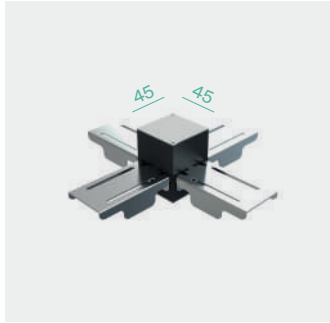

42675 - 42676

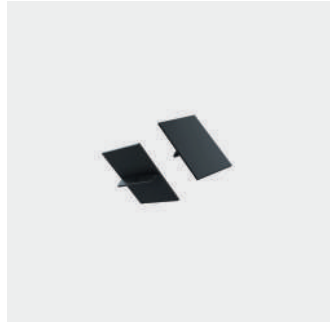

42679 - 42680



42681 - 42682 - 42685



42728

CODE	FINISHING	DESCRIPTION	PRICE
42672	Alluminio/Aluminium	Congiunzione Lineare /Linear Connector	7,08
42673	Nero / Black	Giunto "L"/"L"-Connector	12,75
42674	Bianco / White	Giunto "L"/"L"-Connector	12,75
42675	Nero / Black	Giunto "X"/"X"-Connector	17,69
42676	Bianco / White	Giunto "X"/"X"-Connector	17,69
42677	Nero / Black	Giunto "T"/"T"-Connector	15,57
42678	Bianco / White	Giunto "T"/"T"-Connector	15,57
42679	Nero / Black	Testate (2 Pcs.)/End-Caps	5,67
42680	Bianco / White	Testate (2 Pcs.)/End-Caps	5,67
42681	n/a	Sospensione acciaio 2 mt (1 pz) / Steel cable 2 mt (1 pc)	9,67
42682	Nero/Black	Sospensione e rosone ø115mm 2 mt (1 pz) / Suspension and canopy ø115mm 2 mt (1 pc)	16,75
42685	Bianco / White	Sospensione e rosone ø115mm 2 mt (1 pz) / Suspension and canopy ø115mm 2 mt (1 pc)	16,75
42728	n/a	Attacco a soffitto/Ceiling bracket	5,67





STREAMLIGHT INCASSO

LED Samsung
CRI 82
PF 0.9

CODE	FINISHING	WATT	LUMEN	BEAM	KELVIN	KG	PRICE
42730	Bianco/White	24W	2200	85°*85°	3000K	0,40	46,73
42731	Bianco/White	24W	2400	85°*85°	4000K	0,40	46,73

INSTALLAZIONE APPLICATION



Incasso/Recessed

DISEGNI TECNICI TECHNICAL DRAWINGS

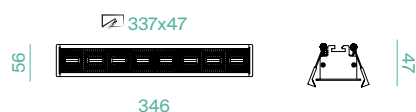

DRIVER

CODE	VOLTAGE	CURRENT	PF	SIZE	MODE	PRICE
42732	24-42V	650mA	0,9	120x45x30	ON-OFF	25,96





STREAMLIGHT

LED Samsung
CRI >80
PF 0.9

CODE	MODEL	FINISHING	WATT	LUMEN	WATT LIGHT SOURCE	LUMEN LIGHT SOURCE	BEAM	KELVIN	KG	PRICE
41094	Asymmetric A	Bianco/White	55W	5300	47W	6625	25°	3000K	1,00	194,66
41095	Asymmetric A	Bianco/White	55W	5700	47W	7125	25°	4000K	1,00	194,66
41098	Asymmetric A	Nero/Black	55W	5300	47W	6625	25°	3000K	1,00	194,66
41099	Asymmetric A	Nero/Black	55W	5700	47W	7125	25°	4000K	1,00	194,66
41096	Asymmetric B	Bianco/White	55W	5300	47W	6625	25°	3000K	1,00	194,66
41097	Asymmetric B	Bianco/White	55W	5700	47W	7125	25°	4000K	1,00	194,66
41100	Asymmetric B	Nero/Black	55W	5300	47W	6625	25°	3000K	1,00	194,66
41101	Asymmetric B	Nero/Black	55W	5700	47W	7125	25°	4000K	1,00	194,66
41102	Symmetric	Bianco/White	55W	5300	47W	6625	85°*85°	3000K	1,00	194,66
41103	Symmetric	Bianco/White	55W	5700	47W	7125	85°*85°	4000K	1,00	194,66
41104	Symmetric	Nero/Black	55W	5300	47W	6625	85°*85°	3000K	1,00	194,66
41105	Symmetric	Nero/Black	55W	5700	47W	7125	85°*85°	4000K	1,00	194,66

INSTALLAZIONE APPLICATION



Binario/Track

DISEGNI TECNICI TECHNICAL DRAWINGS

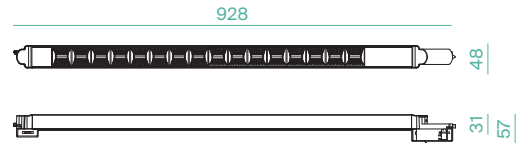

ASYMMETRIC A

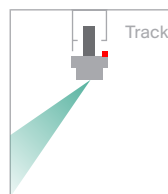

ASYMMETRIC B

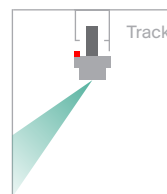

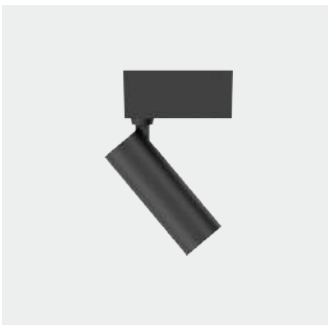

KLIK KLAK PROIETTORE

LED	CREE
CRI	>90
PF	>0.5
SDCM	<3

CODE	FINISHING	WATT	LUMEN	WATT LIGHT SOURCE	LUMEN LIGHT SOURCE	BEAM	KELVIN	KG	PRICE
41111	Nero/Black	10W	749	8W	900	36°	3000K	0,35	90,85
41112	Bianco/White	10W	749	8W	900	36°	3000K	0,35	90,85
41179	Nero/Black	10W	870	8W	1100	36°	4000K	0,35	90,85
41192	Bianco/White	10W	870	8W	1100	36°	4000K	0,35	90,85
41772	Nero/Black	20W	1450	16W	1870	36°	3000K	0,78	135,45
41773	Bianco/White	20W	1450	16W	1870	36°	3000K	0,78	135,45

INSTALLAZIONE APPLICATION



Binario magnetico/
Magnetic track

DISEGNI TECNICI TECHNICAL DRAWINGS

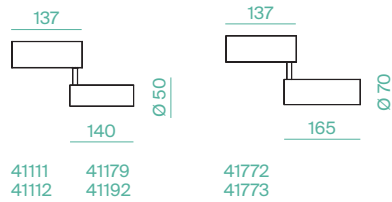

REGOLAZIONI ADJUSTABILITY

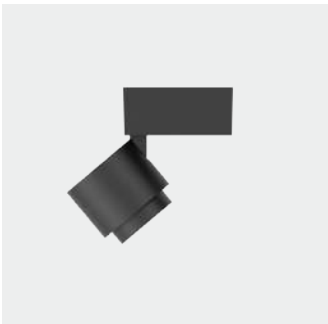

KLIK KLAK PROIETTORE

LED	CREE
CRI	>90
PF	>0.5
SDCM	<3

CODE	FINISHING	WATT	LUMEN	WATT LIGHT SOURCE	LUMEN LIGHT SOURCE	BEAM	KELVIN	KG	PRICE
41176	Nero/Black	8W	404	6W	755	36°	3000K	0,42	96,75
41175	Bianco/White	8W	404	6W	755	36°	3000K	0,42	96,75
41178	Nero/Black	15W	904	12W	1395	36°	3000K	0,57	128,59
41177	Bianco/White	15W	904	12W	1395	36°	3000K	0,57	128,59
41214	Nero/Black	8W	483	6W	816	36°	4000K	0,42	96,75
41213	Bianco/White	8W	483	6W	816	36°	4000K	0,42	96,75
41216	Nero/Black	15W	957	12W	1477	36°	4000K	0,57	128,59
41215	Bianco/White	15W	957	12W	1477	36°	4000K	0,57	128,59

INSTALLAZIONE APPLICATION



Binario magnetico/
Magnetic track

DISEGNI TECNICI TECHNICAL DRAWINGS

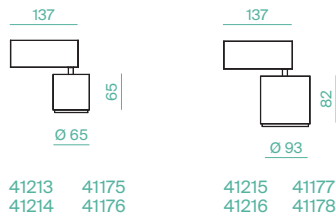

REGOLAZIONI ADJUSTABILITY



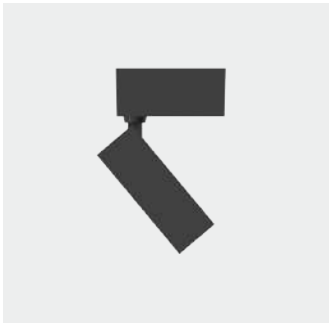

KLIK KLAK PROIETTORE Q

LED CREE
CRI >90
PF >0.5
SDCM <3

CODE	FINISHING	WATT	LUMEN	WATT LIGHT SOURCE	LUMEN LIGHT SOURCE	BEAM	KELVIN	KG	PRICE
41770	Nero/Black	10W	749	8W	900	36°	3000K	0,52	96,60
41771	Bianco/White	10W	749	8W	900	36°	3000K	0,52	96,60

INSTALLAZIONE APPLICATION



Binario magnetico/
Magnetic track

DISEGNI TECNICI TECHNICAL DRAWINGS

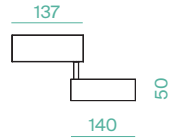

REGOLAZIONI ADJUSTABILITY

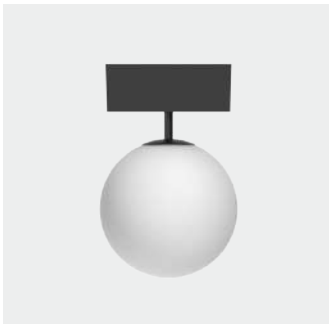

KLIK KLAK GLOBO

LED CREE
CRI >90
PF >0.5
SDCM <3

CODE	FINISHING	WATT	LUMEN	WATT LIGHT SOURCE	LUMEN LIGHT SOURCE	BEAM	KELVIN	KG	PRICE
41778	Nero/Black	10W	680	8W	1105	DIFF.	3000K	0,46	86,10
41779	Bianco/White	10W	680	8W	1105	DIFF.	3000K	0,46	86,10

INSTALLAZIONE APPLICATION



Binario magnetico/
Magnetic track

DISEGNI TECNICI TECHNICAL DRAWINGS

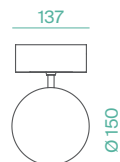

KLIK_KLAK PUNTIFORME

LED CREE
CRI >90
PF >0.5
SDCM <3

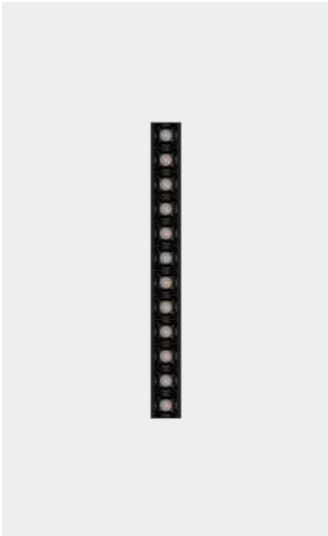
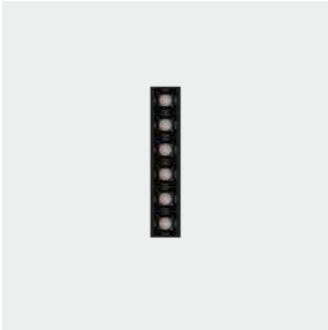
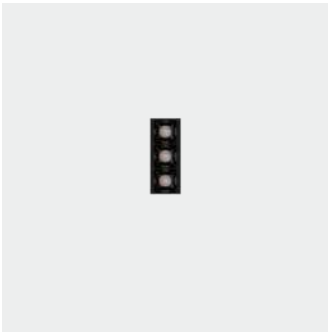

CODE	FINISHING	WATT	LUMEN	WATT LIGHT SOURCE	LUMEN LIGHT SOURCE	BEAM	KELVIN	KG	PRICE
41119	Nero/Black	4W	375	3W	429	34°	3000K	0,16	47,19
41122	Bianco/White	4W	375	3W	429	34°	3000K	0,16	47,19
41120	Nero/Black	8W	788	6W	819	34°	3000K	0,28	66,07
41123	Bianco/White	8W	788	6W	819	34°	3000K	0,28	66,07
41121	Nero/Black	16W	1519	12W	1647	34°	3000K	0,40	116,80
41124	Bianco/White	16W	1519	12W	1647	34°	3000K	0,40	116,80
41199	Nero/Black	4W	381	3W	438	34°	4000K	0,16	47,19
41202	Bianco/White	4W	381	3W	438	34°	4000K	0,16	47,19
41200	Nero/Black	8W	741	6W	832	34°	4000K	0,28	66,07
41203	Bianco/White	8W	741	6W	832	34°	4000K	0,28	66,07
41201	Nero/Black	16W	1530	12W	1729	34°	4000K	0,40	116,80
41204	Bianco/White	16W	1530	12W	1729	34°	4000K	0,40	116,80

INSTALLAZIONE APPLICATION



Binario magnetico/
Magnetic track

DISEGNI TECNICI TECHNICAL DRAWINGS

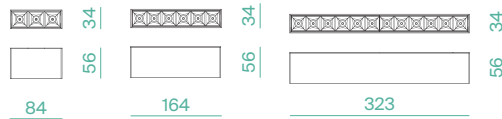

41199
41202
41119
41122

41200
41203
41120
41123

41201
41204
41121
41124



KLIK_KLAK PUNTIFORME ORIENTABILE

LED
CRI >90
PF >0.5
SDCM <3

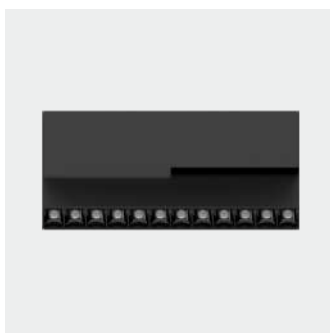
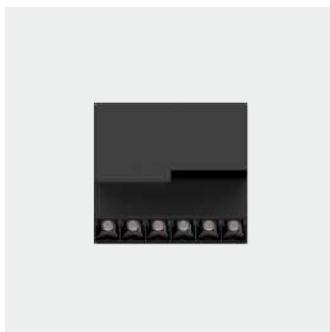
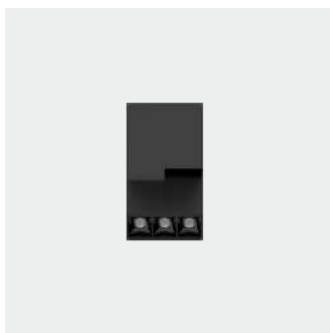

CODE	FINISHING	WATT	LUMEN	WATT LIGHT SOURCE	LUMEN LIGHT SOURCE	BEAM	KELVIN	KG	PRICE
41125	Nero/Black	4W	375	3W	429	34°	3000K	0,49	116,80
41128	Bianco/White	4W	375	3W	429	34°	3000K	0,49	116,80
41126	Nero/Black	8W	788	6W	819	34°	3000K	0,88	152,19
41129	Bianco/White	8W	788	6W	819	34°	3000K	0,88	152,19
41127	Nero/Black	16W	1519	12W	1647	34°	3000K	1,30	234,78
41130	Bianco/White	16W	1519	12W	1647	34°	3000K	1,30	234,78
41205	Nero/Black	4W	381	3W	438	34°	4000K	0,49	116,80
41208	Bianco/White	4W	381	3W	438	34°	4000K	0,49	116,80
41206	Nero/Black	8W	741	6W	832	34°	4000K	0,88	152,19
41209	Bianco/White	8W	741	6W	832	34°	4000K	0,88	152,19
41207	Nero/Black	16W	1530	12W	1729	34°	4000K	1,30	234,78
41210	Bianco/White	16W	1530	12W	1729	34°	4000K	1,30	234,78

INSTALLAZIONE APPLICATION



Binario magnetico/
Magnetic track

DISEGNI TECNICI TECHNICAL DRAWINGS

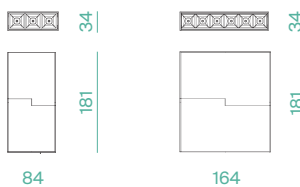

41205
41208
41125
41128

41206
41209
41126
41129

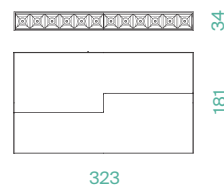

41207
41210
41127
41130

REGOLAZIONI ADJUSTABILITY



KLIK_KLAK LUCÈ DIFFUSA

LED CRI >90
PF >0.5
SDCM <3

CODE	FINISHING	WATT	LUMEN	WATT LIGHT SOURCE	LUMEN LIGHT SOURCE	BEAM	KELVIN	KG	PRICE
41113	Nero/Black	13W	962	10W	1560	105°	3000K	0,48	93,20
41116	Bianco/White	13W	962	10W	1560	105°	3000K	0,48	93,20
41114	Nero/Black	26W	1858	20W	3052	105°	3000K	0,96	163,99
41117	Bianco/White	26W	1858	20W	3052	105°	3000K	0,96	163,99
41115	Nero/Black	39W	2729	30W	4368	105°	3000K	1,44	234,78
41118	Bianco/White	39W	2729	30W	4368	105°	3000K	1,44	234,78
41193	Nero/Black	13W	965	10W	1638	105°	4000K	0,48	93,20
41196	Bianco/White	13W	965	10W	1638	105°	4000K	0,48	93,20
41194	Nero/Black	26W	2030	20W	3113	105°	4000K	0,96	163,99
41197	Bianco/White	26W	2030	20W	3113	105°	4000K	0,96	163,99
41195	Nero/Black	39W	2945	30W	4543	105°	4000K	1,44	234,78
41198	Bianco/White	39W	2945	30W	4543	105°	4000K	1,44	234,78

INSTALLAZIONE APPLICATION



Binario magnetico/
Magnetic track

DISEGNI TECNICI TECHNICAL DRAWINGS



41113 41193
41116 41196



41114 41194
41117 41197



41115 41195
41118 41198





KLIK_KLAK SOSPENSIONE

LED CREE
CRI >90
PF >0.5
SDCM <3

CODE	FINISHING	WATT	LUMEN	WATT LIGHT SOURCE	LUMEN LIGHT SOURCE	BEAM	KELVIN	KG	PRICE
41174	Nero/Black	10W	749	8W	900	36°	3000K	0,56	105,00
41173	Bianco/White	10W	749	8W	900	36°	3000K	0,56	105,00
41212	Nero/Black	10W	870	8W	1100	36°	4000K	0,56	105,00
41211	Bianco/White	10W	870	8W	1100	36°	4000K	0,56	105,00

INSTALLAZIONE APPLICATION



Binario magnetico/
Magnetic track

DISEGNI TECNICI TECHNICAL DRAWINGS

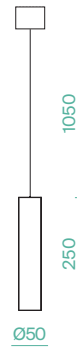

KLIK_KLAK SOSPENSIONE GLOBO

LED CREE
CRI >90
PF >0.5
SDCM <3



CODE	FINISHING	WATT	LUMEN	WATT LIGHT SOURCE	LUMEN LIGHT SOURCE	BEAM	KELVIN	KG	PRICE
41774	Nero/Black	10W	680	8W	1105	DIFF.	3000K	0,50	90,30
41775	Bianco/White	10W	680	8W	1105	DIFF.	3000K	0,50	90,30

INSTALLAZIONE APPLICATION



Binario magnetico/
Magnetic track

DISEGNI TECNICI TECHNICAL DRAWINGS





KLIK_KLAK SOSPENSIONE BELL

LED CREE
CRI >90
PF >0.5
SDCM <3

CODE	FINISHING	WATT	LUMEN	WATT LIGHT SOURCE	LUMEN LIGHT SOURCE	BEAM	KELVIN	KG	PRICE
41776	Nero/Black	10W	415,80	8W	900	65°	3000K	0,44	87,15
41777	Bianco/White	10W	571,90	8W	900	65°	3000K	0,44	87,15

INSTALLAZIONE APPLICATION



Binario magnetico/
Magnetic track

DISEGNI TECNICI TECHNICAL DRAWINGS

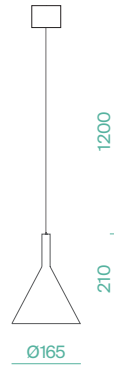

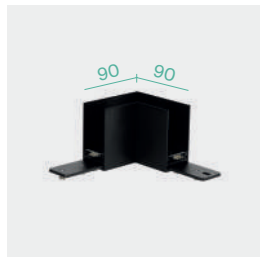

41136 - 41137



41138 - 41139



41140 - 41141

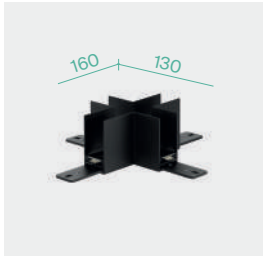

41257 - 41258

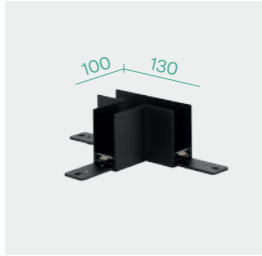

41259 - 41260

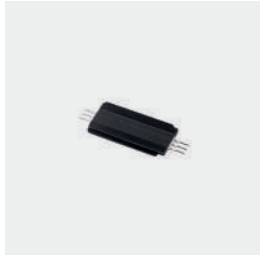

41142 - 41143

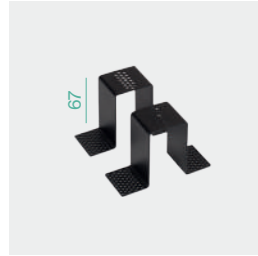

41131

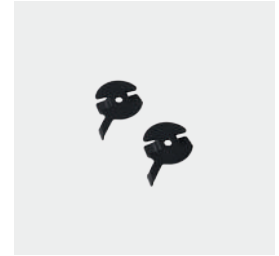

41222 - 41223



41132/A - 41133/A



41134 - 41135



41240 - 41241



42787 - 42784 - 42788 - 42785



42789 - 42786



42811 - 42808 - 42812 - 42809



42813 - 42810

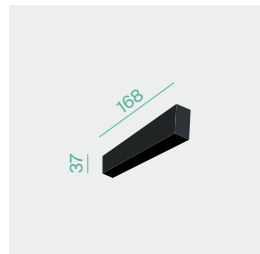

41782 - 41783

CODE	FINISHING	DESCRIPTION	KG	PRICE
41109	Nero/Black	Struttura 1mt in alluminio estruso con testate / 1mt extruded aluminium profile with end-caps	1,50	105,00
41110	Bianco/White	Struttura 1mt in alluminio estruso con testate / 1mt extruded aluminium profile with end-caps	1,50	105,00
41144	Nero/Black	Struttura 2mt in alluminio estruso con testate / 2mt extruded aluminium profile with end-caps	3,00	210,00
41145	Bianco/White	Struttura 2mt in alluminio estruso con testate / 2mt extruded aluminium profile with end-caps	3,00	210,00
41146	Nero/Black	Copertura per rasatura 1 mt/1 mt mask for plasterboard thinning	-	6,49
41136	Nero/Black	Angolo 90° e accessori / 90° corner with accessories	-	51,91
41137	Bianco/White	Angolo 90° e accessori / 90° corner with accessories	-	51,91
41138	Nero/Black	Angolo 90° esterno e accessori/ Outer 90° corner with accessories	-	51,91
41139	Bianco/White	Angolo 90° esterno e accessori/ Outer 90° corner with accessories	-	51,91
41140	Nero/Black	Angolo 90° interno e accessori/ Inner 90° corner with accessories	-	51,91
41141	Bianco/White	Angolo 90° interno e accessori/ Inner 90° corner with accessories	-	51,91

CODE	FINISHING	DESCRIPTION	KG	PRICE
41142	Nero / Black	Congiunzione elettrica con spinotti/ Linear 65mm electric connection with relative 3-pins connector	-	8,26
41143	Bianco / White	Congiunzione elettrica con spinotti/ Linear 65mm electric connection with relative 3-pins connector	-	8,26
41131	Nero / Black	Kit staffe incasso (2 pz)/ Brackets for recessed installation (2 pcs)	-	12,98
41222	Nero / Black	Staffe attacco soffitto kit 2pz/ Brackets for ceiling installation 2 pcs	-	8,14
41223	Bianco / White	Staffe attacco soffitto kit 2pz/ Brackets for ceiling installation 2 pcs	-	8,14
41132	Acciaio/Steel	Sospensione 2mt (1 pz)/ Suspension 2mt (1 pc)	-	12,39
41132/A	Nero / Black	Sospensione con cavo alimentazione 2mt (1 pz)/ Suspension 2mt with electrical wire (1 pc)	-	12,39
41133/A	Bianco / White	Sospensione con cavo alimentazione 2mt (1 pz)/ Suspension 2mt with electrical wire (1 pc)	-	12,39
41134	Nero / Black	Staffa connessione (1 pz)/ Linear connection plate (1 pc)	-	4,71
41135	Bianco / White	Staffa connessione (1 pz)/ Linear connection plate (1 pc)	-	4,71
41258	Nero / Black	Giunto a "X"/"X" connector	-	57,81
41257	Bianco / White	Giunto a "X"/"X" connector	-	57,81
41260	Nero / Black	Giunto a "T"/"T" connector	-	57,81
41259	Bianco / White	Giunto a "T"/"T" connector	-	57,81
41241	Nero / Black	Testata per alimentazione 24V/ Front feed 24V	-	19,47
41240	Bianco / White	Testata per alimentazione 24V/ Front feed 24V	-	19,47
41782	Nero / Black	Ponte di giunzione elettrica 168mm H.37mm/ Electric bridge connector 168mm H.37mm	-	25,46
41783	Bianco / White	Ponte di giunzione elettrica 168mm H.37mm/ Electric bridge connector 168mm H.37mm	-	25,46
42787	Nero / Black	Testata c/ driver 75W 230V dimm./ Front feed w/ driver 75W 230V dimm.	0,70	175,79
42784	Bianco / White	Testata c/ driver 75W 230V dimm./ Front feed w/ driver 75W 230V dimm.	0,70	175,79
42788	Nero / Black	Testata c/ driver 100W 230V dimm./ Front feed w/ driver 100W 230V dimm.	0,70	192,31
42785	Bianco / White	Testata c/ driver 100W 230V dimm./ Front feed w/ driver 100W 230V dimm.	0,70	192,31
42789	Nero / Black	Testata c/ driver 150W 230V dimm./ Front feed w/ driver 150W 230V dimm.	0,80	234,78
42786	Bianco / White	Testata c/ driver 150W 230V dimm./ Front feed w/ driver 150W 230V dimm.	0,80	234,78
42811	Nero / Black	Centrale c/ driver 75W 230V dimm./ Central feed w/ driver 75W 230V dimm.	0,72	180,60
42808	Bianco / White	Centrale c/ driver 75W 230V dimm./ Central feed w/ driver 75W 230V dimm.	0,72	180,60
42812	Nero / Black	Centrale c/ driver 100W 230V dimm./ Central feed w/ driver 100W 230V dimm.	0,72	197,40
42809	Bianco / White	Centrale c/ driver 100W 230V dimm./ Central feed w/ driver 100W 230V dimm.	0,72	197,40
42813	Nero / Black	Centrale c/ driver 150W 230V dimm./ Central feed w/ driver 150W 230V dimm.	0,82	239,40
42810	Bianco / White	Centrale c/ driver 150W 230V dimm./ Central feed w/ driver 150W 230V dimm.	0,82	239,40

DRIVER

CODE	WATT	V	DESCRIPTION	SIZE	MODE	PRICE
22015	50W	24V DC	Driver MW	99x82x30mm	ON-OFF	34,45
22031	60W	24V DC	Driver EAGLERISE TRP	187x45x31mm	ON-OFF	39,69
22032	75W	24V DC	Driver EAGLERISE TRP	187x45x31mm	ON-OFF	50,72
22016	100W	24V DC	Driver MW	129x97x30mm	ON-OFF	61,74
22033	120W	24V DC	Driver EAGLERISE TRP	268x45x31mm	ON-OFF	65,05
22034	150W	24V DC	Driver EAGLERISE TRP	268x45x31mm	ON-OFF	83,79
22025	150W	24V DC	Driver MW	160x95x30mm	ON-OFF	65,05
22017	200W	24V DC	Driver MW	215x115x30mm	ON-OFF	132,30
41217	75W	24V DC	Driver dimmerabile LTECH	144x78x38.5mm	0-10V	149,14
41218	100W	24V DC	Driver dimmerabile LTECH	240x70x36mm	0-10V	164,72
41219	150W	24V DC	Driver dimmerabile LTECH	270x79x39mm	0-10V	208,13
11044	75W	24V DC	Driver LTECH	290x45x30mm	DALI	213,12
11045	150W	24V DC	Driver LTECH	290x45x30mm	DALI	292,62



KLIK_KLAK MINI PROIETTORE

LED CREE
CRI >90
PF >0.5
SDCM <3

CODE	FINISHING	WATT	LUMEN	WATT LIGHT SOURCE	LUMEN LIGHT SOURCE	BEAM	KELVIN	KG	PRICE
41733	Nero/Black	6W	423	5W	630	30°	3000K	0,26	81,90
41734	Bianco/White	6W	423	5W	630	30°	3000K	0,26	81,90

INSTALLAZIONE APPLICATION



Binario magnetico/
Magnetic track

DISEGNI TECNICI TECHNICAL DRAWINGS

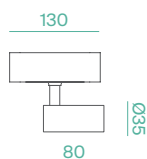

REGOLAZIONI ADJUSTABILITY

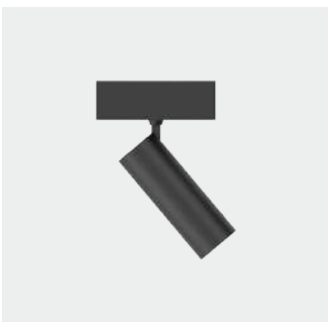

KLIK_KLAK MINI PROIETTORE

LED CREE
CRI >90
PF >0.5
SDCM <3

CODE	FINISHING	WATT	LUMEN	WATT LIGHT SOURCE	LUMEN LIGHT SOURCE	BEAM	KELVIN	KG	PRICE
41735	Nero/Black	10W	749	8W	900	36°	3000K	0,35	85,70
41736	Bianco/White	10W	749	8W	900	36°	3000K	0,35	85,70

INSTALLAZIONE APPLICATION



Binario magnetico/
Magnetic track

DISEGNI TECNICI TECHNICAL DRAWINGS

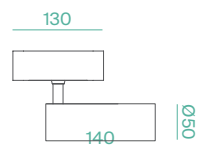

REGOLAZIONI ADJUSTABILITY



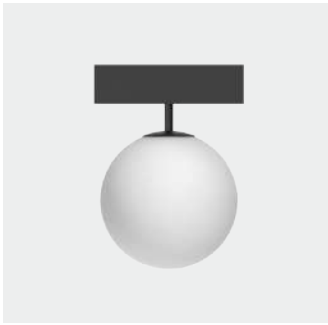

KLIK_KLAK MINI GLOBO

LED CREE
CRI >90
PF >0.5
SDCM <3

CODE	FINISHING	WATT	LUMEN	WATT LIGHT SOURCE	LUMEN LIGHT SOURCE	BEAM	KELVIN	KG	PRICE
41745	Nero/Black	10W	680	8W	1105	DIFF.	3000K	0,46	86,10
41746	Bianco/White	10W	680	8W	1105	DIFF.	3000K	0,46	86,10

INSTALLAZIONE APPLICATION



Binario magnetico/
Magnetic track

DISEGNI TECNICI TECHNICAL DRAWINGS

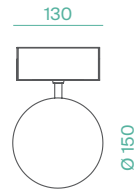

KLIK_KLAK MINI PUNTIFORME

LED CREE
CRI >90
PF >0.5
SDCM <3

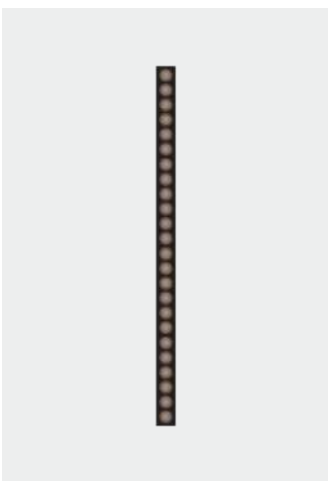
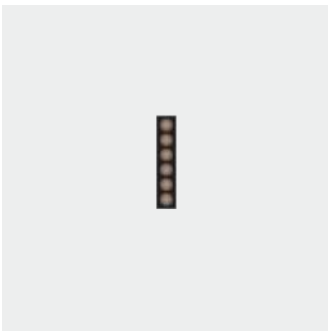

CODE	FINISHING	WATT	LUMEN	WATT LIGHT SOURCE	LUMEN LIGHT SOURCE	BEAM	KELVIN	KG	PRICE
41717	Nero/Black	6W	509	5W	693	30°	3000K	0,12	46,20
41718	Bianco/White	6W	509	5W	693	30°	3000K	0,12	46,20
41719	Nero/Black	12W	1011	10W	1410	30°	3000K	0,18	80,85
41720	Bianco/White	12W	1011	10W	1410	30°	3000K	0,18	80,85
41721	Nero/Black	24W	2041	20W	2750	30°	3000K	0,36	142,80
41722	Bianco/White	24W	2041	20W	2750	30°	3000K	0,36	142,80

INSTALLAZIONE APPLICATION



Binario magnetico/
Magnetic track

DISEGNI TECNICI TECHNICAL DRAWINGS

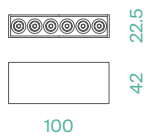

41717
41718

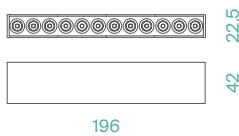

41719
41720

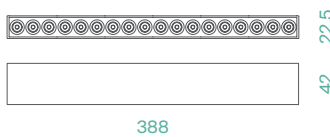

41721
41722



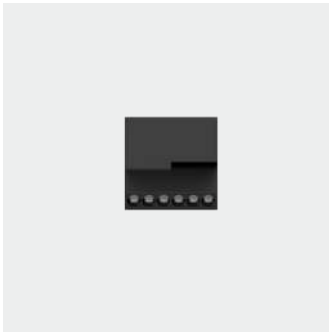

KLIK_KLAK MINI PUNTIFFORME ORIENTABILE

LED CREE
CRI >90
PF >0.5
SDCM <3



CODE	FINISHING	WATT	LUMEN	WATT LIGHT SOURCE	LUMEN LIGHT SOURCE	BEAM	KELVIN	KG	PRICE
41729	Nero/Black	8W	681	6W	819	30°	3000K	0,24	109,20
41730	Bianco/White	8W	681	6W	819	30°	3000K	0,24	109,20
41731	Nero/Black	16W	1198	12W	1647	30°	3000K	0,48	166,95
41732	Bianco/White	16W	1198	12W	1647	30°	3000K	0,48	166,95

INSTALLAZIONE APPLICATION



Binario magnetico/
Magnetic track

DISEGNI TECNICI TECHNICAL DRAWINGS

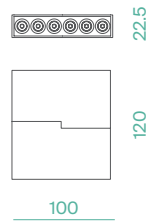

41729
41730

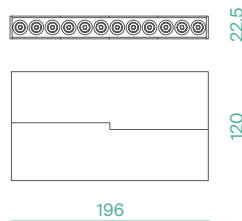

41731
41732

REGOLAZIONI ADJUSTABILITY



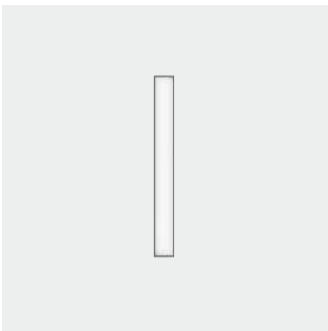

KLIK_KLAK MINI LUCÈ DIFFUSA

LED CREE
CRI >90
PF >0.5
SDCM <3

CODE	FINISHING	WATT	LUMEN	WATT LIGHT SOURCE	LUMEN LIGHT SOURCE	BEAM	KELVIN	KG	PRICE
41723	Nero/Black	8W	605	6W	950	105°	3000K	0,19	65,10
41724	Bianco/White	8W	605	6W	950	105°	3000K	0,19	65,10
41725	Nero/Black	15W	1013	12W	1900	105°	3000K	0,32	114,45
41726	Bianco/White	15W	1013	12W	1900	105°	3000K	0,32	114,45
41727	Nero/Black	30W	1970	23W	3420	105°	3000K	0,66	166,95
41728	Bianco/White	30W	1970	23W	3420	105°	3000K	0,66	166,95

INSTALLAZIONE APPLICATION



Binario magnetico/
Magnetic track

DISEGNI TECNICI TECHNICAL DRAWINGS

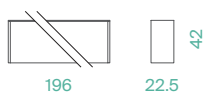

41723
41724



41725
41726



41727
41728



KLIK_KLAK MINI SOSPENSIONE

LED CREE
CRI >90
PF >0.5
SDCM <3



CODE	FINISHING	WATT	LUMEN	WATT LIGHT SOURCE	LUMEN LIGHT SOURCE	BEAM	KELVIN	KG	PRICE
41739	Nero/Black	6W	423	5W	630	30°	3000K	0,48	96,60
41740	Bianco/White	6W	423	5W	630	30°	3000K	0,48	96,60
41737	Nero/Black	10W	749	8W	900	36°	3000K	0,56	99,06
41738	Bianco/White	10W	749	8W	900	36°	3000K	0,56	99,06

INSTALLAZIONE APPLICATION



Binario magnetico/
Magnetic track

DISEGNI TECNICI TECHNICAL DRAWINGS

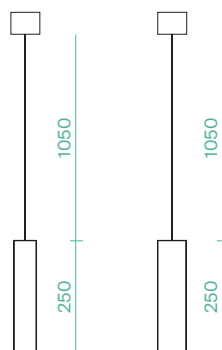

Ø35

41739
41740

Ø50

41737
41738





KLIK_KLAK MINI SOSPENSIONE GLOBO

LED CREE
CRI >90
PF >0.5
SDCM <3

CODE	FINISHING	WATT	LUMEN	WATT LIGHT SOURCE	LUMEN LIGHT SOURCE	BEAM	KELVIN	KG	PRICE
41741	Nero/Black	10W	680	8W	1105	DIFF.	3000K	0,50	90,30
41742	Bianco/White	10W	680	8W	1105	DIFF.	3000K	0,50	90,30

INSTALLAZIONE APPLICATION



Binario magnetico/
Magnetic track

DISEGNI TECNICI TECHNICAL DRAWINGS





KLIK_KLAK MINI SOSPENSIONE BELL

LED CREE
CRI >90
PF >0.5
SDCM <3

CODE	FINISHING	WATT	LUMEN	WATT LIGHT SOURCE	LUMEN LIGHT SOURCE	BEAM	KELVIN	KG	PRICE
41743	Nero/Black	10W	415	8W	900	65°	3000K	0,44	87,15
41744	Bianco/White	10W	571	8W	900	65°	3000K	0,44	87,15

INSTALLAZIONE APPLICATION



Binario magnetico/
Magnetic track

DISEGNI TECNICI TECHNICAL DRAWINGS

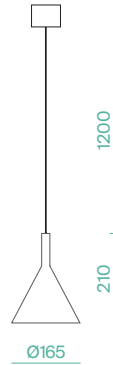

KLIK_KLAK_MINI ACCESSORI ACCESSORIES

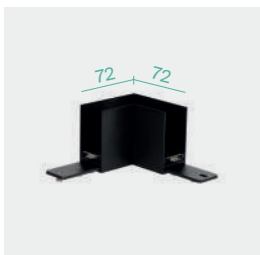

41747 - 41748

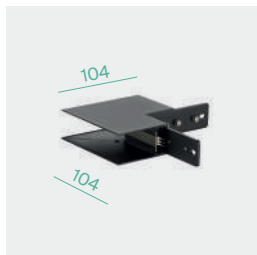

41751 - 41752



41749 - 41750

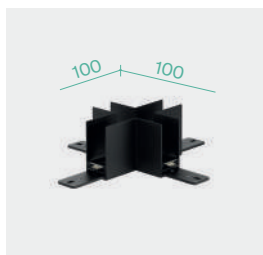

41753 - 41754

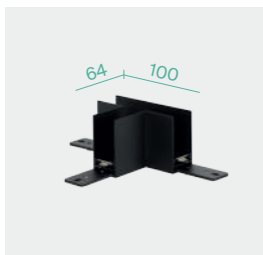

41755 - 41756

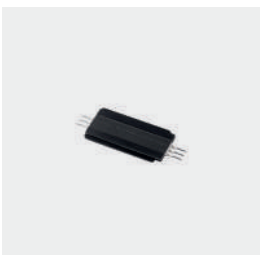

41759 - 41760



41763

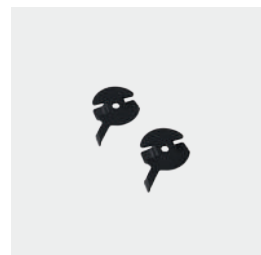

41761 - 41762



41132/A - 41133/A



41757 - 41758



41765 - 41766

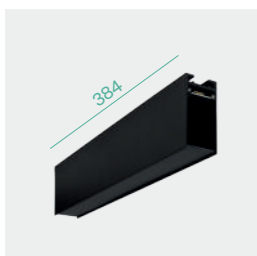

41784 - 41788



41785 - 41789 - 41786 - 41790



42817 - 42814



42818 - 42815 - 42819 - 42816

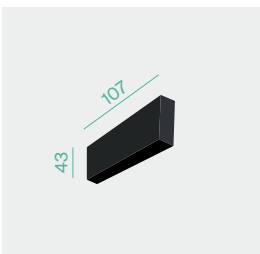

41780 - 41781

CODE	FINISHING	DESCRIPTION	KG	PRICE
41713	Nero / Black	Struttura 1mt in alluminio estruso con testate / 1mt extruded aluminium profile with end-caps	1,14	85,05
41714	Bianco / White	Struttura 1mt in alluminio estruso con testate / 1mt extruded aluminium profile with end-caps	1,14	85,05
41715	Nero / Black	Struttura 2mt in alluminio estruso con testate / 2mt extruded aluminium profile with end-caps	2,28	170,10
41716	Bianco / White	Struttura 2mt in alluminio estruso con testate / 2mt extruded aluminium profile with end-caps	2,28	170,10
41764	Nero / Black	Copertura per rasatura 1 mt/1 mt mask for plasterboard thinning	-	6,12
41747	Nero / Black	Angolo 90° con spinotti e accessori / 90° corner with accessories	-	48,30
41748	Bianco / White	Angolo 90° con spinotti e accessori / 90° corner with accessories	-	48,30
41751	Nero / Black	Angolo 90° esterno e accessori / Outer 90° corner with accessories	-	48,30
41752	Bianco / White	Angolo 90° esterno e accessori / Outer 90° corner with accessories	-	48,30
41749	Nero / Black	Angolo 90° interno e accessori / Inner 90° corner with accessories	-	48,30
41750	Bianco / White	Angolo 90° interno e accessori / Inner 90° corner with accessories	-	48,30

CODE	FINISHING	DESCRIPTION	KG	PRICE
41759	Nero / Black	Congiunzione elettrica con spinotti/ Linear electric connection with relative 3-pins connector	-	7,35
41760	Bianco / White	Congiunzione elettrica con spinotti/ Linear electric connection with relative 3-pins connector	-	7,35
41763	Nero / Black	Kit staffe incasso (2 pz) / Brackets for recessed installation (2 pcs)	-	12,24
41761	Nero / Black	Staffe attacco soffitto kit 2pz / Brackets for ceiling installation 2 pcs	-	7,68
41762	Bianco / White	Staffe attacco soffitto kit 2pz / Brackets for ceiling installation 2 pcs	-	7,68
41132	Acciaio / Steel	Sospensione 2mt (1 pz) / Suspension 2mt (1 pc)	-	12,39
41132/A	Nero / Black	Sospensione con cavo alimentazione 2mt (1 pz) / Suspension 2mt with electrical wire (1 pc)	-	12,39
41133/A	Bianco / White	Sospensione con cavo alimentazione 2mt (1 pz) / Suspension 2mt with electrical wire (1 pc)	-	12,39
41757	Nero / Black	Staffa connessione (1 pz) / Linear connection plate (1 pc)	-	4,20
41758	Bianco / White	Staffa connessione (1 pz) / Linear connection plate (1 pc)	-	4,20
41753	Nero / Black	Giunto a "X"/"X" connector	-	53,55
41754	Bianco / White	Giunto a "X"/"X" connector	-	53,55
41755	Nero / Black	Giunto a "T"/"T" connector	-	53,55
41756	Bianco / White	Giunto a "T"/"T" connector	-	53,55
41765	Nero / Black	Testata per alimentazione 24V / Front feed 24V	-	18,36
41766	Bianco / White	Testata per alimentazione 24V / Front feed 24V	-	18,36
41780	Nero / Black	Ponte di giunzione elettrica 107mm H.43mm / Electric bridge connector 107mm H.43mm	-	25,46
41781	Bianco / White	Ponte di giunzione elettrica 107mm H.43mm / Electric bridge connector 107mm H.43mm	-	25,46
41784	Nero / Black	Testata c/ driver 60W 230V dimm. / Front feed w/ driver 60W 230V dimm.	0,70	161,70
41788	Bianco / White	Testata c/ driver 60W 230V dimm. / Front feed w/ driver 60W 230V dimm.	0,70	161,70
41785	Nero / Black	Testata c/ driver 100W 230V dimm. / Front feed w/ driver 10W 230V dimm.	0,80	216,30
41789	Bianco / White	Testata c/ driver 100W 230V dimm. / Front feed w/ driver 100W 230V dimm.	0,80	216,30
41786	Nero / Black	Testata c/ driver 150W 230V dimm. / Front feed w/ driver 150W 230V dimm.	0,80	266,70
41790	Bianco / White	Testata c/ driver 150W 230V dimm. / Front feed w/ driver 150W 230V dimm.	0,80	266,70
42817	Nero / Black	Centrale c/ driver 60W 230V dimm. / Central feed w/ driver 60W 230V dimm.	0,72	166,95
42814	Bianco / White	Centrale c/ driver 60W 230V dimm. / Central feed w/ driver 60W 230V dimm.	0,72	166,95
42818	Nero / Black	Centrale c/ driver 100W 230V dimm. / Central feed w/ driver 10W 230V dimm.	0,82	222,60
42815	Bianco / White	Centrale c/ driver 100W 230V dimm. / Central feed w/ driver 100W 230V dimm.	0,82	222,60
42819	Nero / Black	Centrale c/ driver 150W 230V dimm. / Central feed w/ driver 150W 230V dimm.	0,82	271,95
42816	Bianco / White	Centrale c/ driver 150W 230V dimm. / Central feed w/ driver 150W 230V dimm.	0,82	271,95

DRIVER

CODE	WATT	V	DESCRIPTION	SIZE	MODE	PRICE
22015	50W	24V DC	Driver MW	99x82x30mm	ON-OFF	34,45
22031	60W	24V DC	Driver EAGLERISE TRP	187x45x31mm	ON-OFF	39,69
22032	75W	24V DC	Driver EAGLERISE TRP	187x45x31mm	ON-OFF	50,72
22016	100W	24V DC	Driver MW	129x97x30mm	ON-OFF	61,74
22033	120W	24V DC	Driver EAGLERISE TRP	268x45x31mm	ON-OFF	65,05
22034	150W	24V DC	Driver EAGLERISE TRP	268x45x31mm	ON-OFF	83,79
22025	150W	24V DC	Driver MW	160x95x30mm	ON-OFF	65,05
22017	200W	24V DC	Driver MW	215x115x30mm	ON-OFF	132,30
41217	75W	24V DC	Driver dimmerabile LTECH	144x78x38.5mm	0-10V	149,14
41218	100W	24V DC	Driver dimmerabile LTECH	240x70x36mm	0-10V	164,72
41219	150W	24V DC	Driver dimmerabile LTECH	270x79x39mm	0-10V	208,13
11044	75W	24V DC	Driver LTECH	290x45x30mm	DALI	213,12
11045	150W	24V DC	Driver LTECH	290x45x30mm	DALI	292,62



FULGOR 15W

LED
CRI
PF

Bridgelux
>90
0.9

CODE	FINISHING	WATT	LUMEN	WATT LIGHT SOURCE	LUMEN LIGHT SOURCE	BEAM	KELVIN	DRIVER	KG	PRICE
41797	Bianco/White	15W	1560	14,8W	1710	15°	3000K	36-38V 350mA	0,4	64,62
41811	Nero/Black	15W	1560	14,8W	1710	15°	3000K	36-38V 350mA	0,4	64,62
41804	Bianco/White	15W	1557	14,8W	1834	15°	4000K	36-38V 350mA	0,4	64,62
41818	Nero/Black	15W	1557	14,8W	1834	15°	4000K	36-38V 350mA	0,4	64,62
41798	Bianco/White	15W	1574	14,8W	1710	24°	3000K	36-38V 350mA	0,4	64,62
41812	Nero/Black	15W	1574	14,8W	1710	24°	3000K	36-38V 350mA	0,4	64,62
41805	Bianco/White	15W	1584	14,8W	1834	24°	4000K	36-38V 350mA	0,4	64,62
41819	Nero/Black	15W	1584	14,8W	1834	24°	4000K	36-38V 350mA	0,4	64,62
41799	Bianco/White	15W	1591	14,8W	1710	38°	3000K	36-38V 350mA	0,4	64,62
41813	Nero/Black	15W	1591	14,8W	1710	38°	3000K	36-38V 350mA	0,4	64,62
41806	Bianco/White	15W	1585	14,8W	1834	38°	4000K	36-38V 350mA	0,4	64,62
41820	Nero/Black	15W	1585	14,8W	1834	38°	4000K	36-38V 350mA	0,4	64,62
41800	Bianco/White	15W	1509	14,8W	1710	55°	3000K	36-38V 350mA	0,4	64,62
41814	Nero/Black	15W	1509	14,8W	1710	55°	3000K	36-38V 350mA	0,4	64,62
41807	Bianco/White	15W	1531	14,8W	1834	55°	4000K	36-38V 350mA	0,4	64,62
41821	Nero/Black	15W	1531	14,8W	1834	55°	4000K	36-38V 350mA	0,4	64,62

INSTALLAZIONE APPLICATION



Binario/Track

DISEGNI TECNICI TECHNICAL DRAWINGS

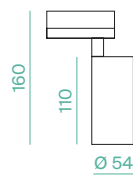

REGOLAZIONI ADJUSTABILITY



ACCESSORI ACCESSORIES

CODE	DESCRIPTION	PRICE
71575	Filtro honeycomb 15W/Honeycomb filter 15W	4,71





FULGOR 15W DALI-PUSH

LED
CRI
PF

Bridgelux
>90
0.9

CODE	FINISHING	WATT	LUMEN	WATT LIGHT SOURCE	LUMEN LIGHT SOURCE	BEAM	KELVIN	DRIVER	KG	PRICE
41825	Bianco/White	15W	1560	14,8W	1710	15°	3000K	36-38V 350mA	0,4	136,00
41847	Nero/Black	15W	1560	14,8W	1710	15°	3000K	36-38V 350mA	0,4	136,00
41836	Bianco/White	15W	1557	14,8W	1834	15°	4000K	36-38V 350mA	0,4	136,00
41858	Nero/Black	15W	1557	14,8W	1834	15°	4000K	36-38V 350mA	0,4	136,00
41826	Bianco/White	15W	1574	14,8W	1710	24°	3000K	36-38V 350mA	0,4	136,00
41848	Nero/Black	15W	1574	14,8W	1710	24°	3000K	36-38V 350mA	0,4	136,00
41837	Bianco/White	15W	1584	14,8W	1834	24°	4000K	36-38V 350mA	0,4	136,00
41859	Nero/Black	15W	1584	14,8W	1834	24°	4000K	36-38V 350mA	0,4	136,00
41827	Bianco/White	15W	1591	14,8W	1710	38°	3000K	36-38V 350mA	0,4	136,00
41849	Nero/Black	15W	1591	14,8W	1710	38°	3000K	36-38V 350mA	0,4	136,00
41838	Bianco/White	15W	1585	14,8W	1834	38°	4000K	36-38V 350mA	0,4	136,00
41860	Nero/Black	15W	1585	14,8W	1834	38°	4000K	36-38V 350mA	0,4	136,00
41828	Bianco/White	15W	1509	14,8W	1710	55°	3000K	36-38V 350mA	0,4	136,00
41850	Nero/Black	15W	1509	14,8W	1710	55°	3000K	36-38V 350mA	0,4	136,00
41839	Bianco/White	15W	1531	14,8W	1834	55°	4000K	36-38V 350mA	0,4	136,00
41861	Nero/Black	15W	1531	14,8W	1834	55°	4000K	36-38V 350mA	0,4	136,00

INSTALLAZIONE APPLICATION



Binario/Track

DISEGNI TECNICI TECHNICAL DRAWINGS

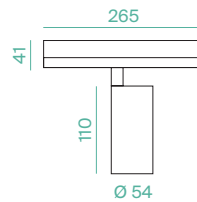

REGOLAZIONI ADJUSTABILITY



ACCESSORI ACCESSORIES

CODE	DESCRIPTION	PRICE
71575	Filtro honeycomb 15W/Honeycomb filter 15W	4,71





FULGOR 24W

LED
CRI
PF

Bridgelux
>90
0.9

CODE	FINISHING	WATT	LUMEN	WATT LIGHT SOURCE	LUMEN LIGHT SOURCE	BEAM	KELVIN	DRIVER	KG	PRICE
41678	Bianco/White	24W	2220	24W	2640	15°	3000K	36-38V 600mA	0,6	77,28
41679	Nero/Black	24W	2220	24W	2640	15°	3000K	36-38V 600mA	0,6	77,28
41680	Bianco/White	24W	2400	24W	2880	15°	4000K	36-38V 600mA	0,6	77,28
41681	Nero/Black	24W	2400	24W	2880	15°	4000K	36-38V 600mA	0,6	77,28
41674	Bianco/White	24W	2280	24W	2640	24°	3000K	36-38V 600mA	0,6	77,28
41675	Nero/Black	24W	2280	24W	2640	24°	3000K	36-38V 600mA	0,6	77,28
41676	Bianco/White	24W	2480	24W	2880	24°	4000K	36-38V 600mA	0,6	77,28
41677	Nero/Black	24W	2480	24W	2880	24°	4000K	36-38V 600mA	0,6	77,28
41670	Bianco/White	24W	2340	24W	2640	38°	3000K	36-38V 600mA	0,6	77,28
41671	Nero/Black	24W	2340	24W	2640	38°	3000K	36-38V 600mA	0,6	77,28
41672	Bianco/White	24W	2550	24W	2880	38°	4000K	36-38V 600mA	0,6	77,28
41673	Nero/Black	24W	2550	24W	2880	38°	4000K	36-38V 600mA	0,6	77,28
41666	Bianco/White	24W	2310	24W	2640	55°	3000K	36-38V 600mA	0,6	77,28
41668	Nero/Black	24W	2310	24W	2640	55°	3000K	36-38V 600mA	0,6	77,28
41667	Bianco/White	24W	2510	24W	2880	55°	4000K	36-38V 600mA	0,6	77,28
41669	Nero/Black	24W	2510	24W	2880	55°	4000K	36-38V 600mA	0,6	77,28

INSTALLAZIONE APPLICATION



Binario/Track

DISEGNI TECNICI TECHNICAL DRAWINGS

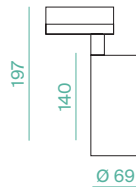

REGOLAZIONI ADJUSTABILITY



ACCESSORI ACCESSORIES

CODE	DESCRIPTION	PRICE
71663	Filtro honeycomb 24W/Honeycomb filter 24W	5,30





FULGOR 24W DALI-PUSH

LED
CRI
PF

Bridgelux
>90
0.9

CODE	FINISHING	WATT	LUMEN	WATT LIGHT SOURCE	LUMEN LIGHT SOURCE	BEAM	KELVIN	DRIVER	KG	PRICE
41829	Bianco/White	24W	2220	24W	2640	15°	3000K	36-38V 600mA	0,6	151,00
41851	Nero/Black	24W	2220	24W	2640	15°	3000K	36-38V 600mA	0,6	151,00
41840	Bianco/White	24W	2400	24W	2880	15°	4000K	36-38V 600mA	0,6	151,00
41862	Nero/Black	24W	2400	24W	2880	15°	4000K	36-38V 600mA	0,6	151,00
41830	Bianco/White	24W	2280	24W	2640	24°	3000K	36-38V 600mA	0,6	151,00
41852	Nero/Black	24W	2280	24W	2640	24°	3000K	36-38V 600mA	0,6	151,00
41841	Bianco/White	24W	2480	24W	2880	24°	4000K	36-38V 600mA	0,6	151,00
41863	Nero/Black	24W	2480	24W	2880	24°	4000K	36-38V 600mA	0,6	151,00
41831	Bianco/White	24W	2340	24W	2640	38°	3000K	36-38V 600mA	0,6	151,00
41853	Nero/Black	24W	2340	24W	2640	38°	3000K	36-38V 600mA	0,6	151,00
41842	Bianco/White	24W	2550	24W	2880	38°	4000K	36-38V 600mA	0,6	151,00
41864	Nero/Black	24W	2550	24W	2880	38°	4000K	36-38V 600mA	0,6	151,00
41832	Bianco/White	24W	2310	24W	2640	55°	3000K	36-38V 600mA	0,6	151,00
41854	Nero/Black	24W	2310	24W	2640	55°	3000K	36-38V 600mA	0,6	151,00
41843	Bianco/White	24W	2510	24W	2880	55°	4000K	36-38V 600mA	0,6	151,00
41865	Nero/Black	24W	2510	24W	2880	55°	4000K	36-38V 600mA	0,6	151,00

INSTALLAZIONE APPLICATION



Binario/Track

DISEGNI TECNICI TECHNICAL DRAWINGS

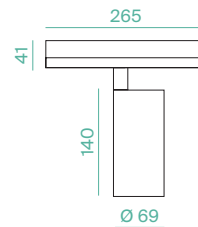

REGOLAZIONI ADJUSTABILITY



ACCESSORI ACCESSORIES

CODE	DESCRIPTION	PRICE
71663	Filtro honeycomb 24W/Honeycomb filter 24W	5,30





FULGOR 35W

LED
CRI
PF

Bridgelux
>90
0.9

CODE	FINISHING	WATT	LUMEN	WATT LIGHT SOURCE	LUMEN LIGHT SOURCE	BEAM	KELVIN	DRIVER	KG	PRICE
41801	Bianco/White	35W	3267	33,5W	3705	15°	3000K	36-38V 850mA	0,86	95,70
41815	Nero/Black	35W	3267	33,5W	3705	15°	3000K	36-38V 850mA	0,86	95,70
41808	Bianco/White	35W	3405	33,5W	3973	15°	4000K	36-38V 850mA	0,86	95,70
41822	Nero/Black	35W	3405	33,5W	3973	15°	4000K	36-38V 850mA	0,86	95,70
41802	Bianco/White	35W	3408	33,5W	3705	24°	3000K	36-38V 850mA	0,86	95,70
41816	Nero/Black	35W	3408	33,5W	3705	24°	3000K	36-38V 850mA	0,86	95,70
41809	Bianco/White	35W	3462	33,5W	3973	24°	4000K	36-38V 850mA	0,86	95,70
41823	Nero/Black	35W	3462	33,5W	3973	24°	4000K	36-38V 850mA	0,86	95,70
41803	Bianco/White	35W	3370	33,5W	3705	38°	3000K	36-38V 850mA	0,86	95,70
41817	Nero/Black	35W	3370	33,5W	3705	38°	3000K	36-38V 850mA	0,86	95,70
41810	Bianco/White	35W	3483	33,5W	3973	38°	4000K	36-38V 850mA	0,86	95,70
41824	Nero/Black	35W	3483	33,5W	3973	38°	4000K	36-38V 850mA	0,86	95,70

INSTALLAZIONE APPLICATION



Binario/Track

DISEGNI TECNICI TECHNICAL DRAWINGS

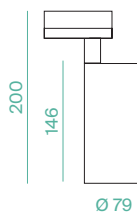

REGOLAZIONI ADJUSTABILITY



ACCESSORI ACCESSORIES

CODE	DESCRIPTION	PRICE
71664	Filtro honeycomb 35W/Honeycomb filter 35W	5,69





FULGOR 35W DALI-PUSH

LED
CRI
PF

Bridgelux
>90
0.9

CODE	FINISHING	WATT	LUMEN	WATT LIGHT SOURCE	LUMEN LIGHT SOURCE	BEAM	KELVIN	DRIVER	KG	PRICE
41833	Bianco/White	35W	3267	33,5W	3705	15°	3000K	36-38V 850mA	0,86	174,00
41855	Nero/Black	35W	3267	33,5W	3705	15°	3000K	36-38V 850mA	0,86	174,00
41844	Bianco/White	35W	3405	33,5W	3973	15°	4000K	36-38V 850mA	0,86	174,00
41866	Nero/Black	35W	3405	33,5W	3973	15°	4000K	36-38V 850mA	0,86	174,00
41834	Bianco/White	35W	3408	33,5W	3705	24°	3000K	36-38V 850mA	0,86	174,00
41856	Nero/Black	35W	3408	33,5W	3705	24°	3000K	36-38V 850mA	0,86	174,00
41845	Bianco/White	35W	3462	33,5W	3973	24°	4000K	36-38V 850mA	0,86	174,00
41867	Nero/Black	35W	3462	33,5W	3973	24°	4000K	36-38V 850mA	0,86	174,00
41835	Bianco/White	35W	3370	33,5W	3705	38°	3000K	36-38V 850mA	0,86	174,00
41857	Nero/Black	35W	3370	33,5W	3705	38°	3000K	36-38V 850mA	0,86	174,00
41846	Bianco/White	35W	3483	33,5W	3973	38°	4000K	36-38V 850mA	0,86	174,00
41868	Nero/Black	35W	3483	33,5W	3973	38°	4000K	36-38V 850mA	0,86	174,00

INSTALLAZIONE APPLICATION



Binario/Track

DISEGNI TECNICI TECHNICAL DRAWINGS

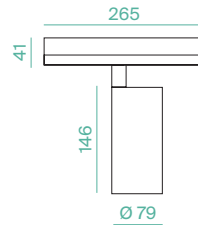

REGOLAZIONI ADJUSTABILITY



ACCESSORI ACCESSORIES

CODE	DESCRIPTION	PRICE
71664	Filtro honeycomb 35W/Honeycomb filter 35W	5,69





UNICO DICRO

Lampadina esclusa / Bulb not included

CODE	FINISHING	BASE	KG	PRICE
40758	Bianco/ White	GU10 230V 50/60HZ	0,30	50,14
40759	Nero/Black	GU10 230V 50/60HZ	0,30	50,14

INSTALLAZIONE APPLICATION



Binario/Track

DISEGNI TECNICI TECHNICAL DRAWINGS

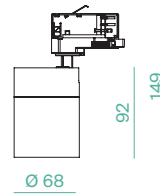

REGOLAZIONI ADJUSTABILITY



UNICO AR111

Lampadina esclusa / Bulb not included

CODE	FINISHING	BASE	KG	PRICE
40754	Bianco/ White	AR111 GU10 230V 50/60HZ	0,50	67,13
40755	Nero/Black	AR111 GU10 230V 50/60HZ	0,50	67,13

INSTALLAZIONE APPLICATION



Binario/Track

DISEGNI TECNICI TECHNICAL DRAWINGS

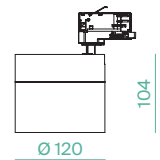

REGOLAZIONI ADJUSTABILITY



TRACKS

CODE	FINISHING	DESCRIPTION	KG	PRICE
60037	Nero/Black	Euro-track binario/track 1 mt.	0,90	34,58
60040	Nero/Black	Euro-track binario/track 2 mt.	1,80	63,72
60043	Nero/Black	Euro-track binario/track 3 mt.	2,70	93,05
60038	Bianco/White	Euro-track binario/track 1 mt.	0,90	34,58
60041	Bianco/White	Euro-track binario/track 2 mt.	1,80	63,72
60044	Bianco/White	Euro-track binario/track 3 mt.	2,70	93,05

INSTALLAZIONE APPLICATION



Soffitto/Ceiling

DISEGNI TECNICI TECHNICAL DRAWINGS

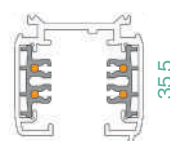

35.2

TRACKS INCASSO

CODE	FINISHING	DESCRIPTION	KG	PRICE
60100	Nero/Black	Track 2 mt.	2,00	74,96
60102	Nero/Black	Track 3 mt.	3,00	109,47
60101	Bianco/White	Track 2 mt.	2,00	74,96
60103	Bianco/White	Track 3 mt.	3,00	109,47

INSTALLAZIONE APPLICATION



Incasso/Recessed

DISEGNI TECNICI TECHNICAL DRAWINGS

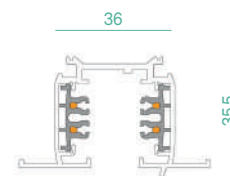

36

35.5

56

ACCESSORI
ACCESSORIES

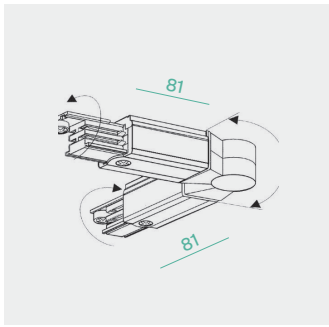

60046 - 60047

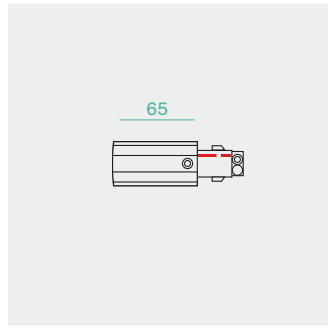

60049 - 60050

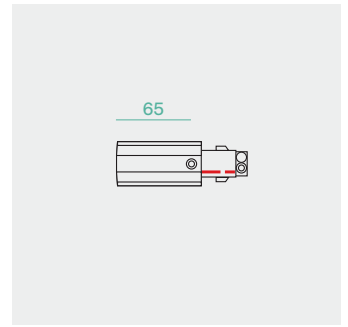

60052 - 60053

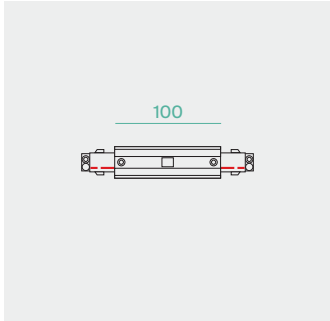

60084 - 60085

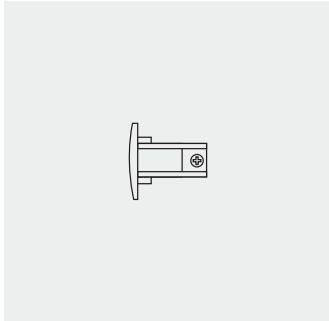

60055 - 60056



60088 - 60089

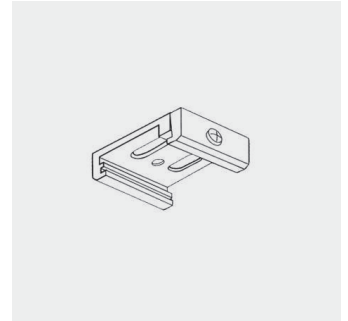

60086 - 60087

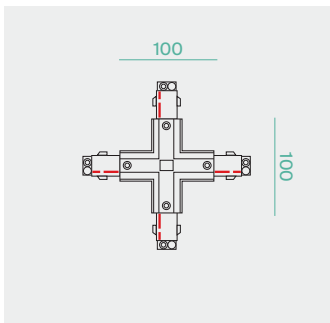

60079 - 60080

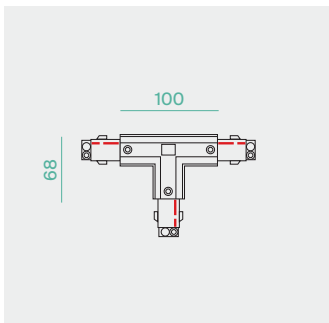

60067 - 60068

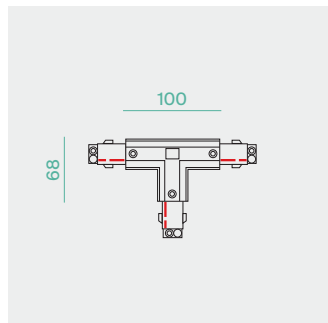

60070 - 60071

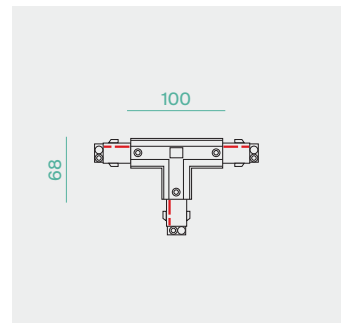

60073 - 60074

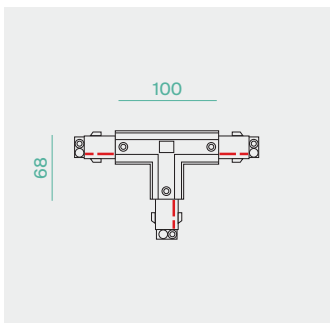

60076 - 60077

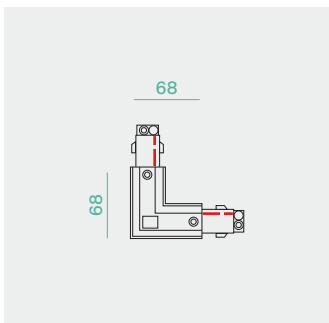

60061 - 60062

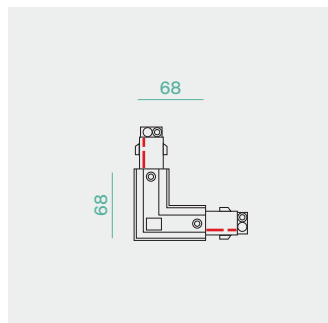

60064 - 60065

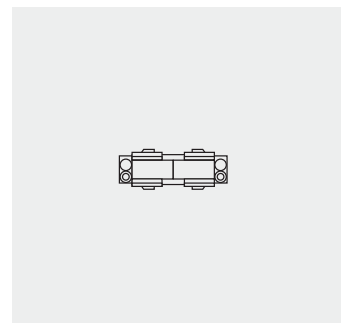

60058 - 60059

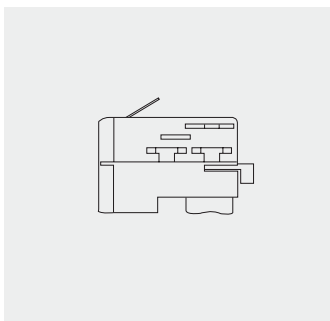

52582/N - 52582/B



11620 - 11621

ACCESSORI ACCESSORIES

CODE	FINISHING	DESCRIPTION	PRICE
60046	Nero/Black	Curva regolabile/Adjustable junction	23,76
60047	Bianco/White	Curva regolabile/Adjustable junction	23,76
60049	Nero/Black	Alimentazione sinistra/Left feed	12,01
60050	Bianco/White	Alimentazione sinistra/Left feed	12,01
60052	Nero/Black	Alimentazione destra/Right feed	12,01
60053	Bianco/White	Alimentazione destra/Right feed	12,01
60084	Nero/Black	Alimentazione centrale/Middle feed	21,76
60085	Bianco/White	Alimentazione centrale/Middle feed	21,76
60055	Nero/Black	Testata di chiusura/End-cap	1,53
60056	Bianco/White	Testata di chiusura/End-cap	1,53
60088	Nero/Black	Kit sospensione con cavo 2 mt./Suspension kit with cable 2 mt.	13,48
60089	Bianco/White	Kit sospensione con cavo 2 mt./Suspension kit with cable 2 mt.	13,48
60086	Nero/Black	Staffa soffitto/Ceiling bracket	4,19
60087	Bianco/White	Staffa soffitto/Ceiling bracket	4,19
60079	Nero/Black	Giunto "+"/"+" connector	36,84
60080	Bianco/White	Giunto "+"/"+" connector	36,84
60067	Nero/Black	Giunto-1 "T"/"T"connector-1	30,98
60068	Bianco/White	Giunto-1 "T"/"T"connector-1	30,98
60070	Nero/Black	Giunto-2 "T"/"T"connector-2	30,98
60071	Bianco/White	Giunto-2 "T"/"T"connector-2	30,98
60073	Nero/Black	Giunto-3 "T"/"T"connector-3	30,98
60074	Bianco/White	Giunto-3 "T"/"T"connector-3	30,98
60076	Nero/Black	Giunto-4 "T"/"T"connector-4	30,98
60077	Bianco/White	Giunto-4 "T"/"T"connector-4	30,98
60061	Nero/Black	Giunto-1 "L"/"L"connector-1	21,76
60062	Bianco/White	Giunto-1 "L"/"L"connector-1	21,76
60064	Nero/Black	Giunto-2 "L"/"L"connector-2	21,76
60065	Bianco/White	Giunto-2 "L"/"L"connector-2	21,76
60058	Nero/Black	Congiunzione/ straight connector	6,67
60059	Bianco/White	Congiunzione/ straight connector	6,67
52582/N	Nero/Black	Adattatore binario/track adaptor	10,38
52582/B	Bianco/White	Adattatore binario/track adaptor	10,38
11621	Nero/Black	Accessorio soffitto per Euro-track / Euro-track ceiling accessory	20,28
11620	Bianco/White	Accessorio soffitto per Euro-track / Euro-track ceiling accessory	20,28

ACCESSORI ACCESSORIES

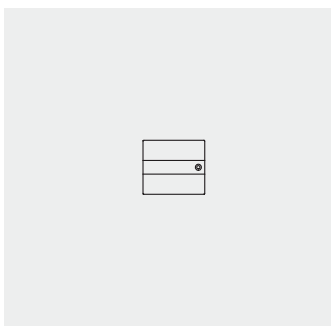

60104 - 60105

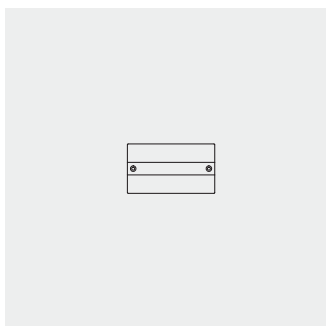

60106 - 60107

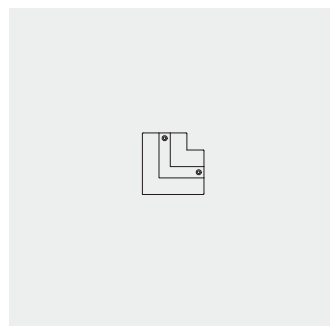

60108 - 60109

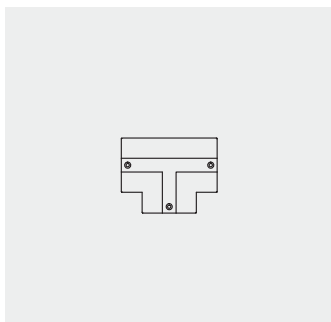

60110 - 60111

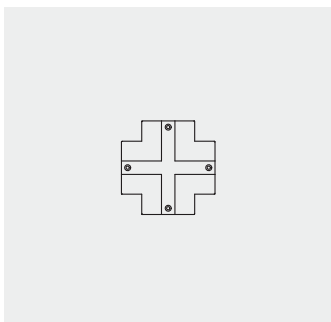

60112 - 60113

CODE	FINISHING	DESCRIPTION	PRICE
60104	Nero/Black	Copertura alim. sx/dx binario incasso/ Right/left feed cover	2,07
60105	Bianco/White	Copertura alim. sx/dx binario incasso/ Right/left feed cover	2,07
60106	Nero/Black	Copertura alim. centrale binario incasso/ Middle feed cover	2,66
60107	Bianco/White	Copertura alim. centrale binario incasso/ Middle feed cover	2,66
60108	Nero/Black	Copertura giunto "L" binario incasso/ "L" connector cover	2,66
60109	Bianco/White	Copertura giunto "L" binario incasso/ "L" connector cover	2,66
60110	Nero/Black	Copertura giunto "T" binario incasso/ "T" connector cover	2,66
60111	Bianco/White	Copertura giunto "T" binario incasso/ "T" connector cover	2,66
60112	Nero/Black	Copertura giunto "+" binario incasso/ "+" connector cover	3,26
60113	Bianco/White	Copertura giunto "+" binario incasso/ "+" connector cover	3,26



EMERGENZA

Lampada emergenza 3W per binari
Autonomia 3 H
Emergency track lamp 3W
3 Hours autonomy

CODE	FINISHING	WATT	LUMEN	KELVIN	PRICE
60091	Nero/Black	3W	110	3000K	156,89
60092	Bianco/White	3W	110	3000K	156,89

INSTALLAZIONE APPLICATION



Binario/Track

DISEGNI TECNICI TECHNICAL DRAWINGS

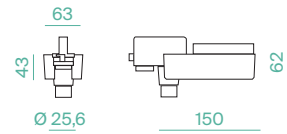



DEEP_EVO FIX

CODE	FINISHING BODY	FINISHING REFLECTOR	MODULI	KG	PRICE
71582	Bianco/White	Bianco/White	Pg. 52-53	0,12	25,37
71583	Bianco/White	Nero/Black	Pg. 52-53	0,12	25,37
71584	Bianco/White	Silver	Pg. 52-53	0,12	25,37
71585	Nero/Black	Bianco/White	Pg. 52-53	0,12	25,37
71586	Nero/Black	Nero/Black	Pg. 52-53	0,12	25,37
71587	Nero/Black	Silver	Pg. 52-53	0,12	25,37



DEEP_EVO ADJUSTABLE

CODE	FINISHING BODY	FINISHING REFLECTOR	MODULI	KG	PRICE	REGOLAZIONI ADJUSTABILITY
71588	Bianco/White	Bianco/White	Pg. 52-53	0,12	25,37	
71589	Bianco/White	Nero/Black	Pg. 52-53	0,12	25,37	
71590	Bianco/White	Silver	Pg. 52-53	0,12	25,37	
71591	Nero/Black	Bianco/White	Pg. 52-53	0,12	25,37	
71592	Nero/Black	Nero/Black	Pg. 52-53	0,12	25,37	
71593	Nero/Black	Silver	Pg. 52-53	0,12	25,37	

INSTALLAZIONE APPLICATION



Incasso/Recessed

DISEGNI TECNICI C/ MODULO LED TECHNICAL DRAWING W/ LED MODULE

LED Module 9W

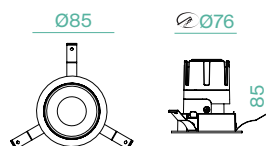

LED Module 12W-15W

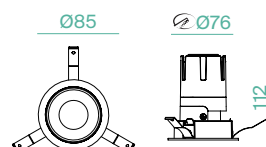



DEEP_EVO LESS FIX

CODE	FINISHING BODY	FINISHING REFLECTOR	MODULI	KG	PRICE
71594	Bianco/White	Bianco/White	Pg. 52-53	0,13	36,46
71595	Bianco/White	Nero/Black	Pg. 52-53	0,13	36,46
71596	Bianco/White	Silver	Pg. 52-53	0,13	36,46



DEEP_EVO LESS ADJUSTABLE

CODE	FINISHING BODY	FINISHING REFLECTOR	MODULI	KG	PRICE	REGOLAZIONI ADJUSTABILITY
71597	Bianco/White	Bianco/White	Pg. 52-53	0,13	36,46	 355° 25°
71598	Bianco/White	Nero/Black	Pg. 52-53	0,13	36,46	
71599	Bianco/White	Silver	Pg. 52-53	0,13	36,46	

INSTALLAZIONE APPLICATION



Incasso a raso/
Recessed

DISEGNI TECNICI C/ MODULO LED TECHNICAL DRAWING W/ LED MODULE

LED Module 9W

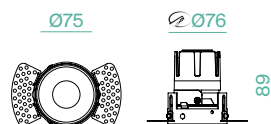

LED Module 12W-15W

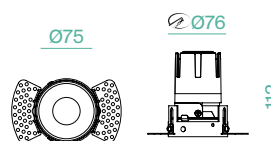



DEEP_EVO_GU10 FIX

CODE	FINISHING BODY	FINISHING REFLECTOR	PLT	KG	PRICE
71645	Bianco/White	Bianco/White	GU10	0,12	38,50
71646	Bianco/White	Nero/Black	GU10	0,12	38,50
71647	Bianco/White	Silver	GU10	0,12	38,50
71651	Nero/Black	Bianco/White	GU10	0,12	38,50
71652	Nero/Black	Nero/Black	GU10	0,12	38,50
71653	Nero/Black	Silver	GU10	0,12	38,50

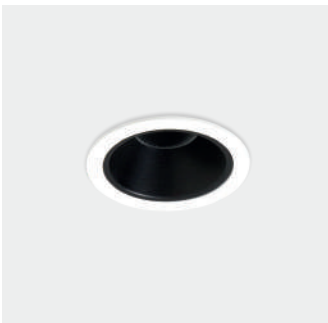

DEEP_EVO_GU10 ADJUSTABLE

CODE	FINISHING BODY	FINISHING REFLECTOR	PLT	KG	PRICE
71648	Bianco/White	Bianco/White	GU10	0,12	38,50
71649	Bianco/White	Nero/Black	GU10	0,12	38,50
71650	Bianco/White	Silver	GU10	0,12	38,50
71654	Nero/Black	Bianco/White	GU10	0,12	38,50
71655	Nero/Black	Nero/Black	GU10	0,12	38,50
71656	Nero/Black	Silver	GU10	0,12	38,50

REGOLAZIONI
ADJUSTABILITY



INSTALLAZIONE
APPLICATION



Incasso/Recessed

DISEGNI TECNICI
TECHNICAL DRAWING

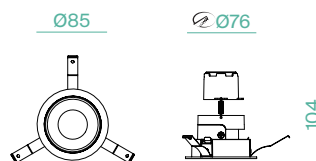



DEEP_EVO LESS_GU10 FIX

CODE	FINISHING BODY	FINISHING REFLECTOR	PLT	KG	PRICE
71657	Bianco/White	Bianco/White	GU10	0,13	42,50
71658	Bianco/White	Nero/Black	GU10	0,13	42,50
71659	Bianco/White	Silver	GU10	0,13	42,50



DEEP_EVO LESS_GU10 ADJUSTABLE

CODE	FINISHING BODY	FINISHING REFLECTOR	PLT	KG	PRICE
71660	Bianco/White	Bianco/White	GU10	0,13	42,50
71661	Bianco/White	Nero/Black	GU10	0,13	42,50
71662	Bianco/White	Silver	GU10	0,13	42,50

REGOLAZIONI
ADJUSTABILITY



INSTALLAZIONE
APPLICATION



Incasso a raso/
Recessed

DISEGNI TECNICI
TECHNICAL DRAWING





DEEP_EVO GRANDE FIX

CODE	FINISHING BODY	FINISHING REFLECTOR	MODULI	KG	PRICE
71729	Bianco/White	Bianco/White	Pg. 52-53	0,22	29,70
71730	Bianco/White	Nero/Black	Pg. 52-53	0,22	29,70
71731	Bianco/White	Silver	Pg. 52-53	0,22	29,70
71732	Nero/Black	Bianco/White	Pg. 52-53	0,22	29,70
71733	Nero/Black	Nero/Black	Pg. 52-53	0,22	29,70
71734	Nero/Black	Silver	Pg. 52-53	0,22	29,70



DEEP_EVO GRANDE ADJUSTABLE

CODE	FINISHING BODY	FINISHING REFLECTOR	MODULI	KG	PRICE
71735	Bianco/White	Bianco/White	Pg. 52-53	0,22	29,70
71736	Bianco/White	Nero/Black	Pg. 52-53	0,22	29,70
71737	Bianco/White	Silver	Pg. 52-53	0,22	29,70
71738	Nero/Black	Bianco/White	Pg. 52-53	0,22	29,70
71739	Nero/Black	Nero/Black	Pg. 52-53	0,22	29,70
71740	Nero/Black	Silver	Pg. 52-53	0,22	29,70

REGOLAZIONI
ADJUSTABILITY



INSTALLAZIONE
APPLICATION



Incasso/Recessed

DISEGNI TECNICI C/ MODULO LED
TECHNICAL DRAWING W/ LED MODULE

LED Module 20W-24W

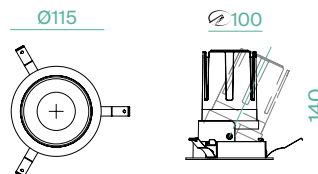



DEEP_EVO LESS GRANDE FIX

CODE	FINISHING BODY	FINISHING REFLECTOR	MODULI	KG	PRICE
71741	Bianco/White	Bianco/White	Pg. 52-53	0,24	39,90
71742	Bianco/White	Nero/Black	Pg. 52-53	0,24	39,90
71743	Bianco/White	Silver	Pg. 52-53	0,24	39,90



DEEP_EVO LESS GRANDE ADJUSTABLE

CODE	FINISHING BODY	FINISHING REFLECTOR	MODULI	KG	PRICE
71744	Bianco/White	Bianco/White	Pg. 52-53	0,24	39,90
71745	Bianco/White	Nero/Black	Pg. 52-53	0,24	39,90
71746	Bianco/White	Silver	Pg. 52-53	0,24	39,90

REGOLAZIONI
ADJUSTABILITY



INSTALLAZIONE
APPLICATION

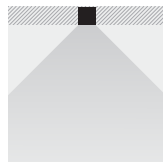

Incasso a raso/
Recessed

DISEGNI TECNICI C/ MODULO LED
TECHNICAL DRAWING W/ LED MODULE

LED Module 20W-24W

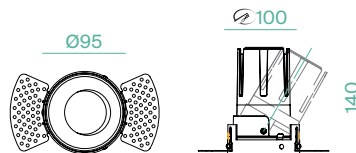



DEEP_EVO_Q FIX/ADJ

CODE	FINISHING BODY	FINISHING REFLECTOR	MODULI	KG	PRICE	REGOLAZIONI ADJUSTABILITY
71705	Bianco/White	Bianco/White	Pg. 52-53	0,13	25,37	
71706	Bianco/White	Nero/Black	Pg. 52-53	0,13	25,37	
71707	Bianco/White	Silver	Pg. 52-53	0,13	25,37	
71708	Nero/Black	Bianco/White	Pg. 52-53	0,13	25,37	
71709	Nero/Black	Nero/Black	Pg. 52-53	0,13	25,37	
71710	Nero/Black	Silver	Pg. 52-53	0,13	25,37	

INSTALLAZIONE APPLICATION



Incasso/Recessed

DISEGNI TECNICI C/ MODULO LED TECHNICAL DRAWING W/ LED MODULE

LED Module 9W

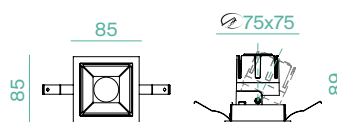

LED Module 12W-15W

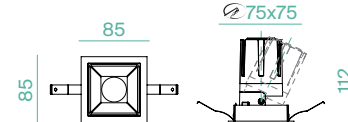

DEEP_EVO LESS_Q FIX/ADJ

CODE	FINISHING BODY	FINISHING REFLECTOR	MODULI	KG	PRICE	REGOLAZIONI ADJUSTABILITY
71711	Bianco/White	Bianco/White	Pg. 52-53	0,14	36,46	
71712	Bianco/White	Nero/Black	Pg. 52-53	0,14	36,46	
71713	Bianco/White	Silver	Pg. 52-53	0,14	36,46	

INSTALLAZIONE APPLICATION



Incasso a raso/
Recessed

DISEGNI TECNICI C/ MODULO LED TECHNICAL DRAWING W/ LED MODULE

LED Module 9W

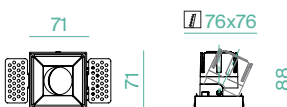

LED Module 12W-15W





DEEP_EVO_Q_GU10 FIX/ADJ

CODE	FINISHING BODY	FINISHING REFLECTOR	PLT	KG	PRICE
71714	Bianco/White	Bianco/White	GU10	0,22	38,50
71715	Bianco/White	Nero/Black	GU10	0,22	38,50
71716	Bianco/White	Silver	GU10	0,22	38,50
71717	Nero/Black	Bianco/White	GU10	0,22	38,50
71718	Nero/Black	Nero/Black	GU10	0,22	38,50
71719	Nero/Black	Silver	GU10	0,22	38,50

REGOLAZIONI
ADJUSTABILITY



355°

25°

INSTALLAZIONE
APPLICATION



Incasso/Recessed

DISEGNI TECNICI
TECHNICAL DRAWING

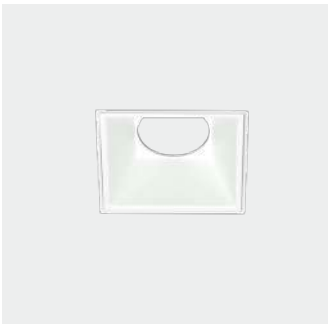
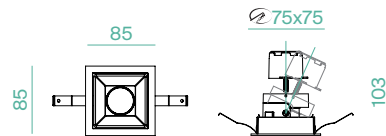

DEEP_EVO LESS_Q_GU10 FIX/ADJ

CODE	FINISHING BODY	FINISHING REFLECTOR	PLT	KG	PRICE
71720	Bianco/White	Bianco/White	GU10	0,24	42,50
71721	Bianco/White	Nero/Black	GU10	0,24	42,50
71722	Bianco/White	Silver	GU10	0,24	42,50

REGOLAZIONI
ADJUSTABILITY



355°

25°

INSTALLAZIONE
APPLICATION



Incasso a raso/
Recessed

DISEGNI TECNICI
TECHNICAL DRAWING

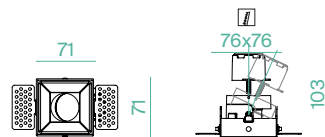



DEEP_EVO_Q GRANDE FIX/ADJ

CODE	FINISHING BODY	FINISHING REFLECTOR	MODULI	KG	PRICE
71723	Bianco/White	Bianco/White	Pg. 52-53	0,24	29,70
71724	Bianco/White	Nero/Black	Pg. 52-53	0,24	29,70
71725	Bianco/White	Silver	Pg. 52-53	0,24	29,70
71726	Nero/Black	Bianco/White	Pg. 52-53	0,24	29,70
71727	Nero/Black	Nero/Black	Pg. 52-53	0,24	29,70
71728	Nero/Black	Silver	Pg. 52-53	0,24	29,70

REGOLAZIONI
ADJUSTABILITY



INSTALLAZIONE
APPLICATION



Incasso/Recessed

DISEGNI TECNICI C/ MODULO LED
TECHNICAL DRAWING W/ LED MODULE

LED Module 20W-24W

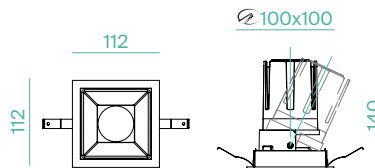



DEEP_EVO STD

CODE	FINISHING BODY	FINISHING REFLECTOR	MODULI	KG	PRICE
71600	Bianco/White	Bianco/White	Pg. 52-53	0,08	12,16
71601	Bianco/White	Nero/Black	Pg. 52-53	0,08	12,16
71602	Bianco/White	Silver	Pg. 52-53	0,08	12,16
71603	Nero/Black	Bianco/White	Pg. 52-53	0,08	12,16
71604	Nero/Black	Nero/Black	Pg. 52-53	0,08	12,16
71605	Nero/Black	Silver	Pg. 52-53	0,08	12,16

INSTALLAZIONE APPLICATION



Incasso/Recessed

DISEGNI TECNICI C/ MODULO LED TECHNICAL DRAWING W/ LED MODULE

LED Module 9W

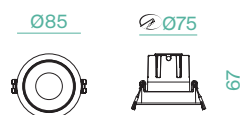

LED Module 12W-15W

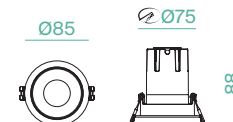

MODULO LED DEEP_EVO

LED
CRI
PF

Bridgelux
>90
>0.9



CODE	WATT	LUMEN	BEAM	KELVIN	DRIVER	MODE	KG	PRICE
71606	9W	715	15°	3000K	30-42V 200mA	ON-OFF	0,16	30,21
71607	9W	725	24°	3000K	30-42V 200mA	ON-OFF	0,16	30,21
71608	9W	710	38°	3000K	30-42V 200mA	ON-OFF	0,16	30,21
71609	9W	695	55°	3000K	30-42V 200mA	ON-OFF	0,16	30,21
71610	12W	1015	15°	3000K	30-42V 300mA	ON-OFF	0,23	32,57
71611	12W	1055	24°	3000K	30-42V 300mA	ON-OFF	0,23	32,57
71612	12W	1050	38°	3000K	30-42V 300mA	ON-OFF	0,23	32,57
71613	12W	1000	55°	3000K	30-42V 300mA	ON-OFF	0,23	32,57
71614	15W	1150	15°	3000K	30-42V 350mA	ON-OFF	0,23	33,75
71615	15W	1170	24°	3000K	30-42V 350mA	ON-OFF	0,23	33,75
71616	15W	1155	38°	3000K	30-42V 350mA	ON-OFF	0,23	33,75
71617	15W	1110	55°	3000K	30-42V 350mA	ON-OFF	0,23	33,75
71747	20W	1863	18°	3000K	40V 500mA	ON-OFF	0,34	40,28
71748	20W	1948	24°	3000K	40V 500mA	ON-OFF	0,34	40,28
71749	20W	1909	35°	3000K	40V 500mA	ON-OFF	0,34	40,28
71750	20W	1873	50°	3000K	40V 500mA	ON-OFF	0,34	40,28
71751	24W	2321	18°	3000K	40V 600mA	ON-OFF	0,34	40,95
71752	24W	2314	24°	3000K	40V 600mA	ON-OFF	0,34	40,95
71753	24W	2307	35°	3000K	40V 600mA	ON-OFF	0,34	40,95
71754	24W	2301	50°	3000K	40V 600mA	ON-OFF	0,34	40,95
71618	9W	715	15°	3000K	30-42V 200mA	1-10V	0,16	54,03
71619	9W	725	24°	3000K	30-42V 200mA	1-10V	0,16	54,03
71620	9W	710	38°	3000K	30-42V 200mA	1-10V	0,16	54,03
71621	9W	695	55°	3000K	30-42V 200mA	1-10V	0,16	54,03
71622	12W	1015	15°	3000K	30-42V 300mA	1-10V	0,23	59,22
71623	12W	1055	24°	3000K	30-42V 300mA	1-10V	0,23	59,22
71624	12W	1050	38°	3000K	30-42V 300mA	1-10V	0,23	59,22
71625	12W	1000	55°	3000K	30-42V 300mA	1-10V	0,23	59,22
71626	15W	1150	15°	3000K	30-42V 350mA	1-10V	0,23	67,01
71627	15W	1170	24°	3000K	30-42V 350mA	1-10V	0,23	67,01
71628	15W	1155	38°	3000K	30-42V 350mA	1-10V	0,23	67,01
71629	15W	1110	55°	3000K	30-42V 350mA	1-10V	0,23	67,01

MODULO LED DEEP_EVO

CODE	WATT	LUMEN	BEAM	KELVIN	DRIVER	MODE	KG	PRICE
71763	9W	715	15°	3000K	30-42V 200mA	DALI/PUSH	0,16	69,98
71764	9W	725	24°	3000K	30-42V 200mA	DALI/PUSH	0,16	69,98
71765	9W	710	38°	3000K	30-42V 200mA	DALI/PUSH	0,16	69,98
71766	9W	695	55°	3000K	30-42V 200mA	DALI/PUSH	0,16	69,98
71767	12W	1015	15°	3000K	30-42V 300mA	DALI/PUSH	0,23	70,20
71768	12W	1055	24°	3000K	30-42V 300mA	DALI/PUSH	0,23	70,20
71769	12W	1050	38°	3000K	30-42V 300mA	DALI/PUSH	0,23	70,20
71770	12W	1000	55°	3000K	30-42V 300mA	DALI/PUSH	0,23	70,20
71771	15W	1150	15°	3000K	30-42V 350mA	DALI/PUSH	0,23	73,80
71772	15W	1170	24°	3000K	30-42V 350mA	DALI/PUSH	0,23	73,80
71773	15W	1155	38°	3000K	30-42V 350mA	DALI/PUSH	0,23	73,80
71774	15W	1110	55°	3000K	30-42V 350mA	DALI/PUSH	0,23	73,80
71755	20W	1863	18°	3000K	40V 500mA	DALI/PUSH	0,34	82,13
71756	20W	1948	24°	3000K	40V 500mA	DALI/PUSH	0,34	82,13
71757	20W	1909	35°	3000K	40V 500mA	DALI/PUSH	0,34	82,13
71758	20W	1873	50°	3000K	40V 500mA	DALI/PUSH	0,34	82,13
71759	24W	2321	18°	3000K	40V 600mA	DALI/PUSH	0,34	91,35
71760	24W	2314	24°	3000K	40V 600mA	DALI/PUSH	0,34	91,35
71761	24W	2307	35°	3000K	40V 600mA	DALI/PUSH	0,34	91,35
71762	24W	2301	50°	3000K	40V 600mA	DALI/PUSH	0,34	91,35

ACCESSORI ACCESSORIES



CODE	DESCRIPTION	PRICE
71575	Filtro honeycomb 9W-12W-15W/Honeycomb filter 9W-12W-15W	4,71
71663	Filtro honeycomb 20W-24W/Honeycomb filter 20W-24W	5,30





FULGOR_IN INCASSO

LED
CRI
PF

Bridgelux
>90
>0.95

CODE	FINISHING	WATT	LUMEN	WATT LIGHT SOURCE	LUMEN LIGHT SOURCE	BEAM	KELVIN	DRIVER	KG	PRICE
41686	Bianco/White	24W	2220	24W	2640	15°	3000K	30-42V 600mA	0,78	112,49
41688	Nero/Black	24W	2220	24W	2640	15°	3000K	30-42V 600mA	0,78	112,49
41687	Bianco/White	24W	2400	24W	2880	15°	4000K	30-42V 600mA	0,78	112,49
41689	Nero/Black	24W	2400	24W	2880	15°	4000K	30-42V 600mA	0,78	112,49
41690	Bianco/White	24W	2280	24W	2640	24°	3000K	30-42V 600mA	0,78	112,49
41692	Nero/Black	24W	2280	24W	2640	24°	3000K	30-42V 600mA	0,78	112,49
41691	Bianco/White	24W	2480	24W	2880	24°	4000K	30-42V 600mA	0,78	112,49
41693	Nero/Black	24W	2480	24W	2880	24°	4000K	30-42V 600mA	0,78	112,49
41682	Bianco/White	24W	2340	24W	2640	38°	3000K	30-42V 600mA	0,78	112,49
41684	Nero/Black	24W	2340	24W	2640	38°	3000K	30-42V 600mA	0,78	112,49
41683	Bianco/White	24W	2550	24W	2880	38°	4000K	30-42V 600mA	0,78	112,49
41685	Nero/Black	24W	2550	24W	2880	38°	4000K	30-42V 600mA	0,78	112,49
41694	Bianco/White	24W	2310	24W	2640	55°	3000K	30-42V 600mA	0,78	112,49
41696	Nero/Black	24W	2310	24W	2640	55°	3000K	30-42V 600mA	0,78	112,49
41695	Bianco/White	24W	2510	24W	2880	55°	4000K	30-42V 600mA	0,78	112,49
41697	Nero/Black	24W	2510	24W	2880	55°	4000K	30-42V 600mA	0,78	112,49

INSTALLAZIONE APPLICATION



Incasso/Recessed

DISEGNI TECNICI TECHNICAL DRAWINGS

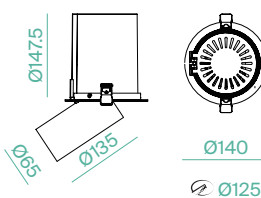

REGOLAZIONI ADJUSTABILITY

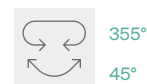

ACCESSORI ACCESSORIES

CODE	DESCRIPTION	PRICE
71663	Filtro honeycomb 24W/Honeycomb filter 24W	5,30





BELLATRIX

LED	OSRAM
CRI	>90
PF	>0.9
UGR	<19

CODE	FINISHING	WATT	LUMEN	BEAM	KELVIN	KG	PRICE
51011	Bianco/White	10,8W	1234/1278	55°	3000K/4000K	0,15	26,46
51012	Bianco/White	16,2W	1712/1779	55°	3000K/4000K	0,19	28,98
51013	Bianco/White	21,6W	2430/2500	55°	3000K/4000K	0,26	45,86
51014	Bianco/White	27W	2961/3140	55°	3000K/4000K	0,35	55,94
51015	Bianco/White	32,4W	3357/3569	55°	3000K/4000K	0,35	58,46

INSTALLAZIONE APPLICATION



Incasso/Recessed

DISEGNI TECNICI TECHNICAL DRAWINGS

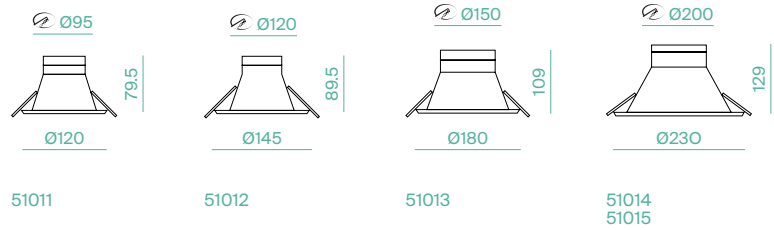

51011

51012

51013

51014
51015

DRIVER

CODE	DESCRIPTION	PRICE
51016	Driver ON/OFF 12W (10,8W) / 36V DC / 300mA	13,10
51017	Driver ON/OFF 18W (16,2W) / 36V DC / 450mA	14,62
51018	Driver ON/OFF 23W (21,6 W) / 36V DC / 600mA	16,13
51019	Driver ON/OFF 28W (27W) / 36V DC / 750mA	16,13
51020	Driver ON/OFF 35W (32,4W) / 36V DC / 900mA	16,13
51021	Driver TRIAC Dimming 12W (10,8W) / 36V DC / 300mA	20,66
51022	Driver TRIAC Dimming 18W (16,2W) / 36V DC / 450mA	22,18
51023	Driver TRIAC Dimming 23W (21,6W) / 36V DC / 600mA	32,26
51024	Driver TRIAC Dimming 28W (27W) / 36V DC / 750mA	32,26
51025	Driver TRIAC Dimming 35W (32,4W) / 36V DC / 900mA	38,81
51026	Driver DALI 2 12W (10,8W) / 36V DC / 300mA	42,05
51027	Driver DALI 2 18W/23W (16,2W/21,6W) / 36V DC / 450-600mA	52,45
51028	Driver DALI 2 28W/35W (27W/32,4W) / 36V DC / 750-900mA	58,12





PUNTO

LED
CRI

OSRAM
90

CODE	FINISHING BODY	FINISHING REFLECTOR	WATT	LUMEN	WATT LIGHT SOURCE	LUMEN LIGHT SOURCE	BEAM	KELVIN	KG	PRICE
42686	Bianco/White	Bianco/White	1,6W	100	1,6W	130	30°	3000K	0,07	36,88
42687	Bianco/White	Argento/Silver	1,6W	100	1,6W	130	30°	3000K	0,07	36,88
42688	Bianco/White	Oro/Gold	1,6W	100	1,6W	130	30°	3000K	0,07	36,88
42689	Bianco/White	Nero/Black	1,6W	100	1,6W	130	30°	3000K	0,07	36,88
42693	Nero/Black	Bianco/White	1,6W	100	1,6W	130	30°	3000K	0,07	36,88
42691	Nero/Black	Argento/Silver	1,6W	100	1,6W	130	30°	3000K	0,07	36,88
42692	Nero/Black	Oro/Gold	1,6W	100	1,6W	130	30°	3000K	0,07	36,88
42690	Nero/Black	Nero/Black	1,6W	100	1,6W	130	30°	3000K	0,07	36,88

INSTALLAZIONE APPLICATION



Incasso/Recessed

DISEGNI TECNICI TECHNICAL DRAWINGS

Ø 35

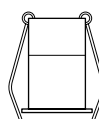

52



Ø 40.5

DRIVER

CODE	VOLTAGE	CURRENT	PF	SIZE	MODE	PRICE
42703	2.5-8V	500mA	>0.5	72x22x22	ON-OFF	6,96





PUNTO L

LED
CRI

Citizen
90

CODE	FINISHING BODY	FINISHING REFLECTOR	WATT	LUMEN	WATT LIGHT SOURCE	LUMEN LIGHT SOURCE	BEAM	KELVIN	KG	PRICE
42694	Bianco/White	Bianco/White	6W	400	6W	500	30°	3000K	0,12	46,48
42695	Bianco/White	Argento/Silver	6W	400	6W	500	30°	3000K	0,12	46,48
42696	Bianco/White	Oro/Gold	6W	400	6W	500	30°	3000K	0,12	46,48
42697	Bianco/White	Nero/Black	6W	400	6W	500	30°	3000K	0,12	46,48
42701	Nero/Black	Bianco/White	6W	400	6W	500	30°	3000K	0,12	46,48
42699	Nero/Black	Argento/Silver	6W	400	6W	500	30°	3000K	0,12	46,48
42700	Nero/Black	Oro/Gold	6W	400	6W	500	30°	3000K	0,12	46,48
42698	Nero/Black	Nero/Black	6W	400	6W	500	30°	3000K	0,12	46,48

INSTALLAZIONE APPLICATION



Incasso/Recessed

DISEGNI TECNICI TECHNICAL DRAWINGS

Ø 45

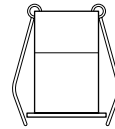

62



Ø 50,5

DRIVER

CODE	VOLTAGE	CURRENT	PF	SIZE	MODE	PRICE
42704	13-26V	350mA	0.95	110x40x23	TRIAC Dimming	16,39
42705	9-18V	350mA	0.95	85x40x23	ON-OFF	11,33





41063 - 41064



41065 - 41066

OCCHIO

LED
CRI

Epistar
>90

CODE	FINISHING	WATT	LUMEN	WATT LIGHT SOURCE	LUMEN LIGHT SOURCE	BEAM	KELVIN	KG	PRICE
41063	Bianco/White	3,5W	250	3,5W	380	60°	3000K	0,06	28,14
41064	Nero/Black	3,5W	250	3,5W	380	60°	3000K	0,06	28,14
41065	Bianco/White	3,5W	250	3,5W	380	60°	3000K	0,06	30,26
41066	Nero/Black	3,5W	250	3,5W	380	60°	3000K	0,06	30,26

INSTALLAZIONE APPLICATION



Incasso/Recessed

DISEGNI TECNICI TECHNICAL DRAWINGS

Ø 36



31,5

Ø 42

41063
41064

Ø 46

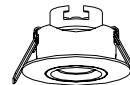

30,5

Ø 52

41065
41066

REGOLAZIONI ADJUSTABILITY



±15°

DRIVER

CODE	VOLTAGE	CURRENT	PF	SIZE	MODE	PRICE
12557	7-14V	300mA	>0.5	53x27x21	ON-OFF	11,68
12556	6-12V	300mA	>0.5	40x32x20	TRIAC Dimming	17,58



Fix: IP44/20 Adj: IP20



MINI 20

LED
CRI

OSRAM
>80

CODE	FINISHING	WATT	LUMEN	WATT LIGHT SOURCE	LUMEN LIGHT SOURCE	BEAM	KELVIN	KG	PRICE
42737	Bianco/White	1,2W	92	1,2W	120	20°	3000K	0,04	18,29
42738	Nero/Black	1,2W	92	1,2W	120	20°	3000K	0,04	18,29

INSTALLAZIONE APPLICATION



Incasso/Recessed

DISEGNI TECNICI TECHNICAL DRAWINGS

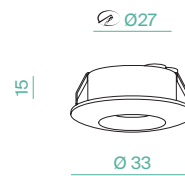

DRIVER

CODE	VOLTAGE	CURRENT	PF	SIZE	DIMMABLE	PRICE
42743	2-5V	350mA	0.5	53x31x21	ON-OFF	10,97





MINI 105

LED
CRI

OSRAM
>80

CODE	FINISHING	WATT	LUMEN	WATT LIGHT SOURCE	LUMEN LIGHT SOURCE	BEAM	KELVIN	KG	PRICE
42739	Bianco/White	1,2W	71	1,2W	120	105°	3000K	0,03	18,29
42740	Nero/Black	1,2W	71	1,2W	120	105°	3000K	0,03	18,29

INSTALLAZIONE APPLICATION



Incasso/Recessed

DISEGNI TECNICI TECHNICAL DRAWINGS



DRIVER

CODE	VOLTAGE	CURRENT	PF	SIZE	MODE	PRICE
42743	2-5V	350mA	0.5	53x31x21	ON-OFF	10,97





MINI 60

LED
CRI

OSRAM
>80

CODE	FINISHING	WATT	LUMEN	WATT LIGHT SOURCE	LUMEN LIGHT SOURCE	BEAM	KELVIN	KG	PRICE
42741	Bianco/White	1.2W	94	1.2W	120	60°	3000K	0,03	18,29
42742	Nero/Black	1.2W	94	1.2W	120	60°	3000K	0,03	18,29

INSTALLAZIONE APPLICATION



Incasso/Recessed

DISEGNI TECNICI TECHNICAL DRAWINGS



DRIVER

CODE	VOLTAGE	CURRENT	PF	SIZE	MODE	PRICE
42743	2-5V	350mA	0.5	53x31x21	ON-OFF	10,97





ZEUS

LED
CRI

EPISTAR
>80

CODE	FINISHING	WATT	LUMEN	WATT LIGHT SOURCE	LUMEN LIGHT SOURCE	BEAM	KELVIN	KG	PRICE
42745	Bianco/White	3W	285	3W	360	90°	3000K	0,07	20,64
42744	Nero/Black	3W	285	3W	360	90°	3000K	0,07	20,64

INSTALLAZIONE APPLICATION



Incasso/Recessed

DISEGNI TECNICI TECHNICAL DRAWINGS

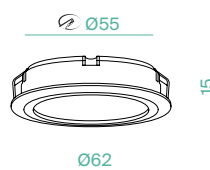

DRIVER

CODE	VOLTAGE	CURRENT	PF	SIZE	MODE	PRICE
12557	7-14V	300mA	>0.5	53x27x21	ON-OFF	11,68
12556	6-12V	300mA	>0.5	40x32x20	TRIAC Dimming	17,58





AQUA COB

LED Ledteen
CRI >80
PF >0.5



CODE	FINISHING	WATT	LUMEN	BEAM	KELVIN	KG	PRICE
40430	Bianco / White	8W	678	60°	3000K	0,17	35,50

INSTALLAZIONE APPLICATION



Incasso/Recessed

DISEGNI TECNICI TECHNICAL DRAWINGS

Ø 75

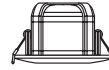

55

Ø 90



IP65

230V
50/60Hz



AQUA SMD

LED Cree
CRI >80
PF >0.5



CODE	FINISHING	WATT	LUMEN	BEAM	KELVIN	KG	PRICE
40429	Bianco / White	6W	368	110°	3000K	0,10	21,06

INSTALLAZIONE APPLICATION



Incasso/Recessed

DISEGNI TECNICI TECHNICAL DRAWINGS

Ø 75



28.5

Ø 90



IP65

230V
50/60Hz





FRAME

Lampadina esclusa / Bulb not included

CODE	FINISHING	BASE	KG	PRICE
53421/GU10	Bianco / White	GU10 230V 50/60Hz~ Max.50W	0,60	38,19
53426/GU10	Nero / Black	GU10 230V 50/60Hz~ Max.50W	0,60	38,19

INSTALLAZIONE APPLICATION



Incasso/Recessed

DISEGNI TECNICI TECHNICAL DRAWINGS

106x106

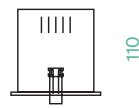

118x118

REGOLAZIONI ADJUSTABILITY



FRAME

Lampadina esclusa / Bulb not included

CODE	FINISHING	BASE	KG	PRICE
53423/GU10	Bianco / White	GU10 230V 50/60Hz~ Max.2x50W	0,80	62,61
53427/GU10	Nero / Black	GU10 230V 50/60Hz~ Max.2x50W	0,80	62,61

INSTALLAZIONE APPLICATION



Incasso/Recessed

DISEGNI TECNICI TECHNICAL DRAWINGS

211x106

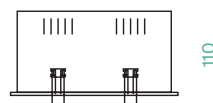

223x118

REGOLAZIONI ADJUSTABILITY





FRAME

Lampadina esclusa / Bulb not included

CODE	FINISHING	BASE	KG	PRICE
53425/GU10	Bianco / White	GU10 230V 50/60Hz~ Max.3x50W	1,00	87,03
53428/GU10	Nero / Black	GU10 230V 50/60Hz~ Max.3x50W	1,00	87,03

INSTALLAZIONE APPLICATION



Incasso/Recessed

DISEGNI TECNICI TECHNICAL DRAWINGS

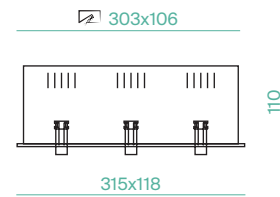

REGOLAZIONI ADJUSTABILITY



FRAME 111

Lampadina esclusa / Bulb not included

CODE	FINISHING	BASE	KG	PRICE
53433/GU10	Bianco / White	AR111 GU10 230V 50/60Hz~ Max.50W	1,00	51,48
53429/GU10	Nero / Black	AR111 GU10 230V 50/60Hz~ Max.50W	1,00	51,48

INSTALLAZIONE APPLICATION



Incasso/Recessed

DISEGNI TECNICI TECHNICAL DRAWINGS

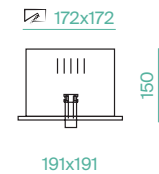

REGOLAZIONI ADJUSTABILITY





FRAME 111

Lampadina esclusa / Bulb not included

CODE	FINISHING	BASE	KG	PRICE
53435/GU10	Bianco / White	AR111 GU10 230V 50/60Hz~ Max.2x50W	1,80	85,10
53430/GU10	Nero / Black	AR111 GU10 230V 50/60Hz~ Max.2x50W	1,80	85,10

INSTALLAZIONE APPLICATION



Incasso/Recessed

DISEGNI TECNICI TECHNICAL DRAWINGS

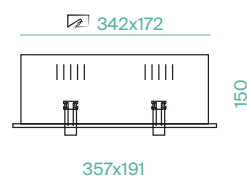

REGOLAZIONI ADJUSTABILITY



FRAME 111

Lampadina esclusa / Bulb not included

CODE	FINISHING	BASE	KG	PRICE
53437/GU10	Bianco / White	AR111 GU10 230V 50/60Hz~ Max.3x50W	2,40	121,40
53431/GU10	Nero / Black	AR111 GU10 230V 50/60Hz~ Max.3x50W	2,40	121,40

INSTALLAZIONE APPLICATION



Incasso/Recessed

DISEGNI TECNICI TECHNICAL DRAWINGS

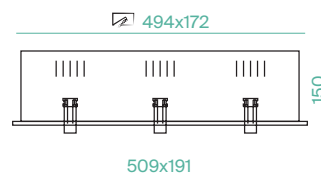

REGOLAZIONI ADJUSTABILITY





FRAMELESS

Lampadina esclusa / Bulb not included

CODE	FINISHING	BASE	KG	PRICE
53448B/GU10	Bianco / White	GU10 230V 50/60Hz~ Max.50W	0,80	45,28
53448/GU10	Nero / Black	GU10 230V 50/60Hz~ Max.50W	0,80	45,28

INSTALLAZIONE APPLICATION



Incasso/Recessed

DISEGNI TECNICI TECHNICAL DRAWINGS

103x103



REGOLAZIONI ADJUSTABILITY



FRAMELESS

Lampadina esclusa / Bulb not included

CODE	FINISHING	BASE	KG	PRICE
53449B/GU10	Bianco / White	GU10 230V 50/60Hz~ Max.2x50W	1,00	69,12
53449/GU10	Nero / Black	GU10 230V 50/60Hz~ Max.2x50W	1,00	69,12

INSTALLAZIONE APPLICATION



Incasso/Recessed

DISEGNI TECNICI TECHNICAL DRAWINGS

208x103

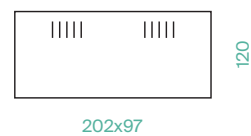

REGOLAZIONI ADJUSTABILITY





FRAMELESS

Lampadina esclusa / Bulb not included

CODE	FINISHING	BASE	KG	PRICE
53450B/GU10	Bianco / White	GU10 230V 50/60Hz~ Max.3x50W	1,40	94,25
53450/GU10	Nero / Black	GU10 230V 50/60Hz~ Max.3x50W	1,40	94,25

INSTALLAZIONE APPLICATION



Incasso/Recessed

DISEGNI TECNICI TECHNICAL DRAWINGS



REGOLAZIONI ADJUSTABILITY



FRAMELESS 111

Lampadina esclusa / Bulb not included

CODE	FINISHING	BASE	KG	PRICE
53454B/GU10	Bianco / White	AR111 GU10 230V 50/60Hz~ Max.50W	1,00	59,40
53454/GU10	Nero / Black	AR111 GU10 230V 50/60Hz~ Max.50W	1,00	59,40

INSTALLAZIONE APPLICATION



Incasso/Recessed

DISEGNI TECNICI TECHNICAL DRAWINGS

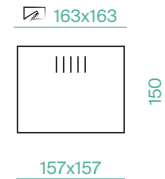

REGOLAZIONI ADJUSTABILITY





FRAMELESS 111

Lampadina esclusa / Bulb not included

CODE	FINISHING	BASE	KG	PRICE
53455B/GU10	Bianco / White	AR111 GU10 230V 50/60Hz~ Max.2x50W	1,80	95,04
53455/GU10	Nero / Black	AR111 GU10 230V 50/60Hz~ Max.2x50W	1,80	95,04

INSTALLAZIONE APPLICATION



Incasso/Recessed

DISEGNI TECNICI TECHNICAL DRAWINGS

328x163

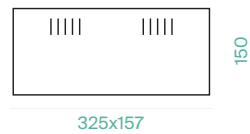

325x157

REGOLAZIONI ADJUSTABILITY



±45°



FRAMELESS 111

Lampadina esclusa / Bulb not included

CODE	FINISHING	BASE	KG	PRICE
53456B/GU10	Bianco / White	AR111 GU10 230V 50/60Hz~ Max.3x50W	2,40	126,37
53456/GU10	Nero / Black	AR111 GU10 230V 50/60Hz~ Max.3x50W	2,40	126,37

INSTALLAZIONE APPLICATION



Incasso/Recessed

DISEGNI TECNICI TECHNICAL DRAWINGS

481x163



477x157

REGOLAZIONI ADJUSTABILITY



±45°





WIZARD

Lampadina esclusa / Bulb not included

CODE	FINISHING	BASE	KG	PRICE
42749	Bianco / White	GU10 230V 50/60Hz~ Max.50W	0,20	23,48
42750	Nero / Black	GU10 230V 50/60Hz~ Max.50W	0,20	23,48
42747	Bianco / White	AR111 GU10 230V 50/60Hz~ Max.50W	0,43	32,91
42748	Nero / Black	AR111 GU10 230V 50/60Hz~ Max.50W	0,43	32,91

INSTALLAZIONE APPLICATION



Incasso/Recessed

REGOLAZIONI ADJUSTABILITY



42749
42750



42747
42748

DISEGNI TECNICI TECHNICAL DRAWINGS

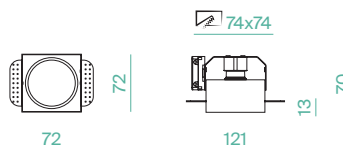

42749
42750

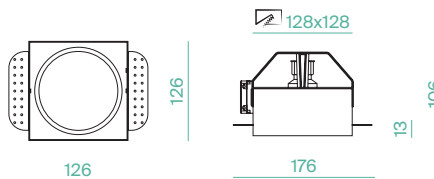

42747
42748



IP20

230V
50/60Hz





DEEP C/VETRO

Lampadina esclusa / Bulb not included

CODE	FINISHING	BASE	KG	PRICE
54511	Bianco / White	GU10 230V 50/60Hz	0,30	17,36
54541	Nero / Black	GU10 230V 50/60Hz	0,30	17,36

INSTALLAZIONE APPLICATION

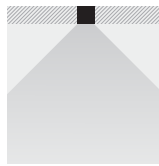

Incasso/Recessed

DISEGNI TECNICI TECHNICAL DRAWINGS

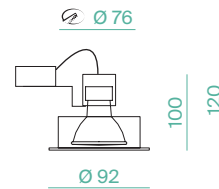

DEEP C/VETRO

Lampadina esclusa / Bulb not included

CODE	FINISHING	BASE	KG	PRICE
54527	Bianco / White	GU10 230V 50/60Hz	0,30	17,36
54542	Nero / Black	GU10 230V 50/60Hz	0,30	17,36

INSTALLAZIONE APPLICATION



Incasso/Recessed

DISEGNI TECNICI TECHNICAL DRAWINGS

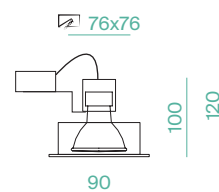



DEEP ZERO

Lampadina esclusa / Bulb not included

CODE	FINISHING	BASE	KG	PRICE
54519	Bianco / White	GU10 230V 50/60Hz~ Max.50W	0,25	15,77
54543	Nero / Black	GU10 230V 50/60Hz~ Max.50W	0,25	15,77

INSTALLAZIONE APPLICATION



Incasso/Recessed

DISEGNI TECNICI TECHNICAL DRAWINGS

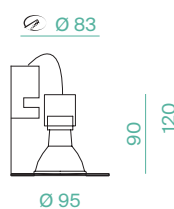

REGOLAZIONI ADJUSTABILITY



DEEP ZERO

Lampadina esclusa / Bulb not included

CODE	FINISHING	BASE	KG	PRICE
54531	Bianco / White	GU10 230V 50/60Hz~ Max.50W	0,25	15,77
54544	Nero / Black	GU10 230V 50/60Hz~ Max.50W	0,25	15,77

INSTALLAZIONE APPLICATION



Incasso/Recessed

DISEGNI TECNICI TECHNICAL DRAWINGS

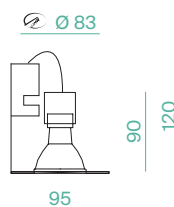

REGOLAZIONI ADJUSTABILITY





DEEP

Lampadina esclusa / Bulb not included

CODE	FINISHING	BASE	KG	PRICE
54523	Bianco / White	GU10 230V 50/60Hz~ Max.50W	0,25	19,61
54545	Nero / Black	GU10 230V 50/60Hz~ Max.50W	0,25	19,61

INSTALLAZIONE APPLICATION

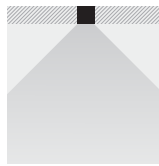

Incasso/Recessed

DISEGNI TECNICI TECHNICAL DRAWINGS

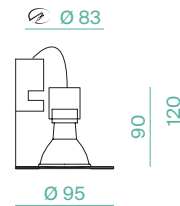

REGOLAZIONI ADJUSTABILITY



DEEP

Lampadina esclusa / Bulb not included

CODE	FINISHING	BASE	KG	PRICE
54539	Bianco / White	GU10 230V 50/60Hz	0,25	19,61
54546	Nero / Black	GU10 230V 50/60Hz	0,25	19,61

INSTALLAZIONE APPLICATION



Incasso/Recessed

DISEGNI TECNICI TECHNICAL DRAWINGS

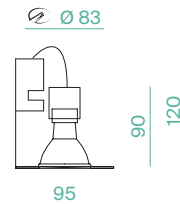

REGOLAZIONI ADJUSTABILITY





ZEN

LED
CRI

OSRAM
>80

Ricarica con base di appoggio wireless con alimentatore (compreso)
Charging through wireless base with charger (included)

CODE	FINISHING	WATT	LUMEN	WATT LIGHT SOURCE	LUMEN LIGHT SOURCE	BEAM	KELVIN	KG	PRICE
42793	Antracite/Dark Grey	2.5W	120	1.7W	206	120°	2700/ 3000K	0,55	114,45
42794	Bianco/Matt White	2.5W	120	1.7W	206	120°	2700/ 3000K	0,55	114,45
42795	Sabbia/Sand	2.5W	120	1.7W	206	120°	2700/ 3000K	0,55	114,45
42796	Cromo/Chrome	2.5W	120	1.7W	206	120°	2700/ 3000K	0,55	171,15
42797	Oro/Gold	2.5W	120	1.7W	206	120°	2700/ 3000K	0,55	171,15
42798	Rame/Copper	2.5W	120	1.7W	206	120°	2700/ 3000K	0,55	171,15
42799	Grigio Siderale/ Space Grey	2.5W	120	1.7W	206	120°	2700/ 3000K	0,55	171,15

INSTALLAZIONE APPLICATION

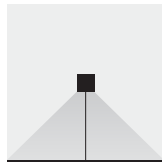

Appoggio/Standing

DISEGNI TECNICI TECHNICAL DRAWINGS

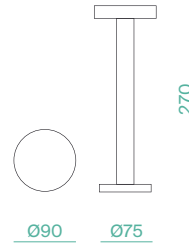

ACCESSORI ACCESSORIES

CODE	DESCRIPTION	ALIMENTAZIONE/AC-DC ADAPTOR	PRICE
11654	Base ricarica multipla x6 lampade Multiple charger x6 lamps	100-240V 50/60Hz 9VDC 5A 45W	153,37

DISEGNI TECNICI TECHNICAL DRAWINGS

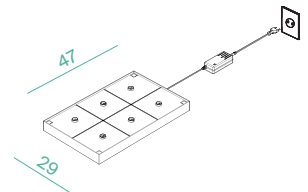

La garanzia fornita dalla casa sulla batteria è di 12 mesi
/Manufacturer's warranty on battery is 12 months



IOTA

LED
CRI

OSRAM
>80

Ricarica con cavo USB-C con alimentatore (compreso)
Charging through USB-C cable with charger (included)

CODE	FINISHING	WATT	LUMEN	WATT LIGHT SOURCE	LUMEN LIGHT SOURCE	BEAM	KELVIN	KG	PRICE
42800	Antracite/Dark Grey	2.5W	120	1.8W	200	120°	2700/3000K	0,75	103,95
42801	Bianco/Matt White	2.5W	120	1.8W	200	120°	2700/3000K	0,75	103,95
42802	Nero/Matt Black	2.5W	120	1.8W	200	120°	2700/3000K	0,75	103,95
42803	Sabbia/Sand	2.5W	120	1.8W	200	120°	2700/3000K	0,75	103,95
42804	Rosso Rubino/Ruby Red	2.5W	120	1.8W	200	120°	2700/3000K	0,75	103,95
42805	Verde Salvia/Sage Green	2.5W	120	1.8W	200	120°	2700/3000K	0,75	103,95
42806	Blu Oceano/Ocean Blue	2.5W	120	1.8W	200	120°	2700/3000K	0,75	103,95
42807	Corten	2.5W	120	1.8W	200	120°	2700/3000K	0,75	103,95

INSTALLAZIONE APPLICATION



Appoggio/Standing Sospesa/Hanging

DISEGNI TECNICI TECHNICAL DRAWINGS

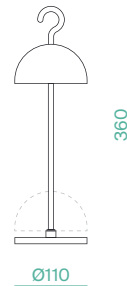

La garanzia fornita dalla casa sulla batteria è di 12 mesi
/Manufacturer's warranty on battery is 12 months



ADIOGENE

LED
CRI

OSRAM
>80

Ricarica con cavo USB-C con alimentatore (compreso)
Charging through USB-C cable with charger (included)

CODE	FINISHING	WATT	LUMEN	WATT LIGHT SOURCE	LUMEN LIGHT SOURCE	BEAM	KELVIN	KG	PRICE
42720	Antracite/Anthracite	2.2W	200	1.8W	205	120°	2700/ 3000K	1,60	116,80
42721	Bianco/White	2.2W	200	1.8W	205	120°	2700/ 3000K	1,60	116,80
42722	Nero/Black	2.2W	200	1.8W	205	120°	2700/ 3000K	1,60	116,80
42723	Corten	2.2W	200	1.8W	205	120°	2700/ 3000K	1,60	116,80
42762	Sabbia/Sand	2.2W	200	1.8W	205	120°	2700/ 3000K	1,60	116,80

INSTALLAZIONE APPLICATION

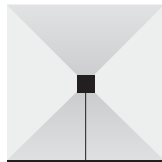

Appoggio/Standing

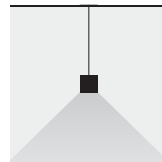

Sospesa/Hanging

DISEGNI TECNICI TECHNICAL DRAWINGS

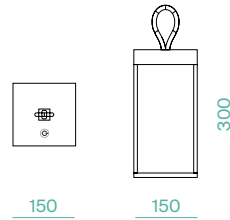

IP65 IK04



La garanzia fornita dalla casa sulla batteria è di 12 mesi
/Manufacturer's warranty on battery is 12 months



DIOGENE L

LED
CRI

OSRAM
>80

Ricarica con cavo USB-C con alimentatore (compreso)
Charging through USB-C cable with charger (included)

CODE	FINISHING	WATT	LUMEN	WATT LIGHT SOURCE	LUMEN LIGHT SOURCE	BEAM	KELVIN	KG	PRICE
42724	Antracite/Anthracite	2.2W	200	1.8W	205	120°	2700/ 3000K	1,80	127,42
42725	Bianco/White	2.2W	200	1.8W	205	120°	2700/ 3000K	1,80	127,42
42726	Nero/Black	2.2W	200	1.8W	205	120°	2700/ 3000K	1,80	127,42
42727	Corten	2.2W	200	1.8W	205	120°	2700/ 3000K	1,80	127,42
42763	Sabbia/Sand	2.2W	200	1.8W	205	120°	2700/ 3000K	1,80	127,42

INSTALLAZIONE APPLICATION



Appoggio/Standing

Sospesa/Hanging

DISEGNI TECNICI TECHNICAL DRAWINGS

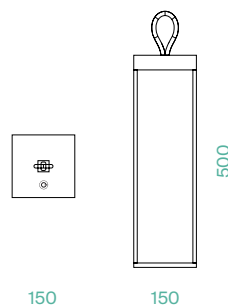

150

150

500



La garanzia fornita dalla casa sulla batteria è di 12 mesi
/Manufacturer's warranty on battery is 12 months



DIogene HYBRID

LED
CRI

OSRAM
>80

Ricarica con pannello solare o cavo USB-C con alimentatore (compreso)
Charging through solar panel or USB-C cable with charger (included)

CODE	FINISHING	WATT	LUMEN	WATT LIGHT SOURCE	LUMEN LIGHT SOURCE	BEAM	KELVIN	KG	PRICE
42764	Antracite/Anthracite	2.2W	150	1.8W	209	120°	2700/ 3000K	1,59	152,19
42765	Bianco/White	2.2W	150	1.8W	209	120°	2700/ 3000K	1,59	152,19
42766	Nero/Black	2.2W	150	1.8W	209	120°	2700/ 3000K	1,59	152,19
42767	Corten	2.2W	150	1.8W	209	120°	2700/ 3000K	1,59	152,19
42768	Sabbia/Sand	2.2W	150	1.8W	209	120°	2700/ 3000K	1,59	152,19

INSTALLAZIONE APPLICATION

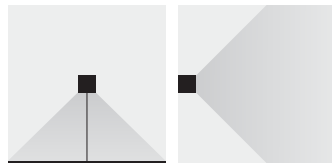

Appoggio/Standing

Parete/Wall

DISEGNI TECNICI TECHNICAL DRAWINGS

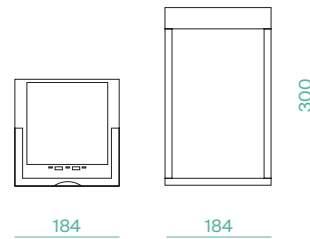

ACCESSORI ACCESSORIES

CODE	COLOR	DESCRIPTION	PRICE
11659	Antracite/Anthracite	Staffa per montaggio a muro/Wall mounting brackets	18,88
11660	Bianco/White	Staffa per montaggio a muro/Wall mounting brackets	18,88
11661	Nero/Black	Staffa per montaggio a muro/Wall mounting brackets	18,88
11662	Corten	Staffa per montaggio a muro/Wall mounting brackets	18,88
11663	Sabbia/Sand	Staffa per montaggio a muro/Wall mounting brackets	18,88

DISEGNI TECNICI TECHNICAL DRAWINGS

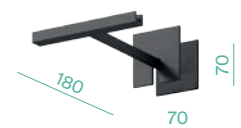

La garanzia fornita dalla casa sulla batteria è di 12 mesi
/Manufacturer's warranty on battery is 12 months



UDIOGENE HYBRID L

LED
CRI

OSRAM
>80

Ricarica con pannello solare o cavo USB-C con alimentatore (compreso)
Charging through solar panel or USB-C cable with charger (included)

CODE	FINISHING	WATT	LUMEN	WATT LIGHT SOURCE	LUMEN LIGHT SOURCE	BEAM	KELVIN	KG	PRICE
42769	Antracite/Anthracite	2.2W	150	1.8W	209	120°	2700/ 3000K	1,69	160,45
42770	Bianco/White	2.2W	150	1.8W	209	120°	2700/ 3000K	1,69	160,45
42771	Nero/Black	2.2W	150	1.8W	209	120°	2700/ 3000K	1,69	160,45
42772	Corten	2.2W	150	1.8W	209	120°	2700/ 3000K	1,69	160,45
42773	Sabbia/Sand	2.2W	150	1.8W	209	120°	2700/ 3000K	1,69	160,45

INSTALLAZIONE APPLICATION

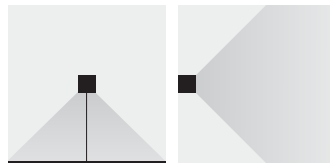

Appoggio/Standing Parete/Wall

DISEGNI TECNICI TECHNICAL DRAWINGS

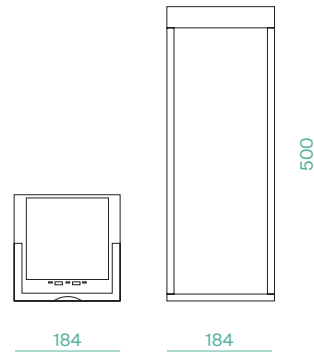

ACCESSORI ACCESSORIES

CODE	COLOR	DESCRIPTION	PRICE
11659	Antracite/Anthracite	Staffa per montaggio a muro/Wall mounting brackets	18,88
11660	Bianco/White	Staffa per montaggio a muro/Wall mounting brackets	18,88
11661	Nero/Black	Staffa per montaggio a muro/Wall mounting brackets	18,88
11662	Corten	Staffa per montaggio a muro/Wall mounting brackets	18,88
11663	Sabbia/Sand	Staffa per montaggio a muro/Wall mounting brackets	18,88

DISEGNI TECNICI TECHNICAL DRAWINGS

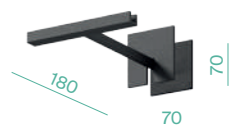

La garanzia fornita dalla casa sulla batteria è di 12 mesi
/Manufacturer's warranty on battery is 12 months



TWIGGY_LESS

LED
CRI

OSRAM
>80

Ricarica con base di appoggio wireless con alimentatore (compreso)
Charging through wireless base with charger (included)

CODE	FINISHING	WATT	LUMEN	WATT LIGHT SOURCE	LUMEN LIGHT SOURCE	BEAM	KELVIN	KG	PRICE
42753	Antracite/Anthracite	2.2W	150	1.8W	217	100°	2700/ 3000K	0,85	100,29
42754	Bianco/White	2.2W	150	1.8W	217	100°	2700/ 3000K	0,85	100,29
42755	Nero/Black	2.2W	150	1.8W	217	100°	2700/ 3000K	0,85	100,29
42756	Corten	2.2W	150	1.8W	217	100°	2700/ 3000K	0,85	100,29
42757	Giallo/Yellow	2.2W	150	1.8W	217	100°	2700/ 3000K	0,85	100,29
42758	Arancione/Orange	2.2W	150	1.8W	217	100°	2700/ 3000K	0,85	100,29
42759	Verde Salvia/ Sage Green	2.2W	150	1.8W	217	100°	2700/ 3000K	0,85	100,29
42760	Blu Avio	2.2W	150	1.8W	217	100°	2700/ 3000K	0,85	100,29
42761	Sabbia/Sand	2.2W	150	1.8W	217	100°	2700/ 3000K	0,85	100,29
42820	Rossa/Red	2.2W	150	1.8W	217	100°	2700/ 3000K	0,85	100,29

CODE	DESCRIPTION	PRICE
11371	Espositore lampade wireless / Display cabinet for wireless lamps	80,00

INSTALLAZIONE APPLICATION

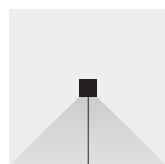

Appoggio/Standing

DISEGNI TECNICI TECHNICAL DRAWINGS

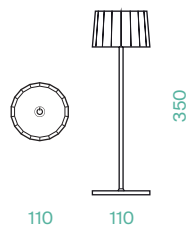

ACCESSORI ACCESSORIES

CODE	DESCRIPTION	ALIMENTAZIONE/AC-DC ADAPTOR	PRICE
11654	Base ricarica multipla x6 lampade Multiple charger x6 lamps	100-240V 50/60Hz 9VDC 5A 45W	153,37

DISEGNI TECNICI TECHNICAL DRAWINGS

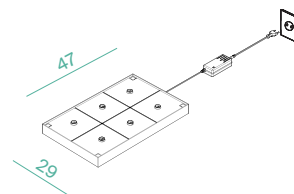

La garanzia fornita dalla casa sulla batteria è di 12 mesi
/Manufacturer's warranty on battery is 12 months



A+B SOFFITTO DALI-PUSH

LED	EPISTAR
CRI	>90
PF	>0.9
SDCM	<6
UGR	<16

CODE	FINISHING	WATT	LUMEN	WATT LIGHT SOURCE	LUMEN LIGHT SOURCE	BEAM	KELVIN	DRIVER	KG	PRICE
41889	Bianco/White	↓ 26W+ ↑ 12W	2412 + 1471	26W+11,6W	3236+1501	90°+ 120°	3000K	38W 30-40V 1050mA	3,6	364,95
41891	Bianco/White	↓ 26W+ ↑ 12W	2629 + 1603	26W+11,6W	3603+1636	90°+ 120°	4000K	38W 30-40V 1050mA	3,6	364,95
41890	Bianco/White	↓ 38W+ ↑ 20W	3570 + 2317	36W+20W	4109+2685	90°+ 120°	3000K	38W 30-40V 1050mA + 20W 30-40V 500mA	4,8	514,27
41892	Bianco/White	↓ 38W+ ↑ 20W	3892 + 2525	36W+20W	4782+2926	90°+ 120°	4000K	38W 30-40V 1050mA + 20W 30-40V 500mA	4,8	514,27

INSTALLAZIONE APPLICATION



Soffitto/Ceiling

DISEGNI TECNICI TECHNICAL DRAWINGS



41889
41891



41890
41892





FULGOR SOFFITTO/PARETE

LED
CRI
PF

Bridgelux
>90
0.9

CODE	FINISHING	WATT	LUMEN	WATT LIGHT SOURCE	LUMEN LIGHT SOURCE	BEAM	KELVIN	DRIVER	KG	PRICE
41869	Bianco/White	15W	1560	14,8W	1710	15°	3000K	36-38V 350mA	0,6	64,62
41877	Nero/Black	15W	1560	14,8W	1710	15°	3000K	36-38V 350mA	0,6	64,62
41873	Bianco/White	15W	1557	14,8W	1834	15°	4000K	36-38V 350mA	0,6	64,62
41881	Nero/Black	15W	1557	14,8W	1834	15°	4000K	36-38V 350mA	0,6	64,62
41870	Bianco/White	15W	1574	14,8W	1710	24°	3000K	36-38V 350mA	0,6	64,62
41878	Nero/Black	15W	1574	14,8W	1710	24°	3000K	36-38V 350mA	0,6	64,62
41874	Bianco/White	15W	1584	14,8W	1834	24°	4000K	36-38V 350mA	0,6	64,62
41882	Nero/Black	15W	1584	14,8W	1834	24°	4000K	36-38V 350mA	0,6	64,62
41871	Bianco/White	15W	1591	14,8W	1710	38°	3000K	36-38V 350mA	0,6	64,62
41879	Nero/Black	15W	1591	14,8W	1710	38°	3000K	36-38V 350mA	0,6	64,62
41875	Bianco/White	15W	1585	14,8W	1834	38°	4000K	36-38V 350mA	0,6	64,62
41883	Nero/Black	15W	1585	14,8W	1834	38°	4000K	36-38V 350mA	0,6	64,62
41872	Bianco/White	15W	1509	14,8W	1710	55°	3000K	36-38V 350mA	0,6	64,62
41880	Nero/Black	15W	1509	14,8W	1710	55°	3000K	36-38V 350mA	0,6	64,62
41876	Bianco/White	15W	1531	14,8W	1834	55°	4000K	36-38V 350mA	0,6	64,62
41884	Nero/Black	15W	1531	14,8W	1834	55°	4000K	36-38V 350mA	0,6	64,62

INSTALLAZIONE APPLICATION



Soffitto/Ceiling

Parete/Wall

DISEGNI TECNICI TECHNICAL DRAWINGS

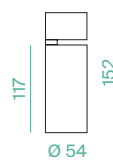

REGOLAZIONI ADJUSTABILITY



ACCESSORI ACCESSORIES

CODE	DESCRIPTION	PRICE
71575	Filtro honeycomb 15W/Honeycomb filter 15W	4,71



IP20





UNICO DICRO SOFFITTO/PARETE

Lampadina esclusa / Bulb not included

CODE	FINISHING	BASE	KG	PRICE
40760	Bianco/White	GU10 230V 50/60HZ	0,26	60,17
40761	Nero/Black	GU10 230V 50/60HZ	0,26	60,17

INSTALLAZIONE APPLICATION



Soffitto/Ceiling

Parete/Wall

DISEGNI TECNICI TECHNICAL DRAWINGS

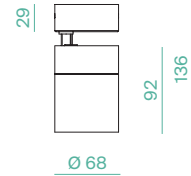

REGOLAZIONI ADJUSTABILITY



CYL

LED
CRI >90
PF 0.5

CODE	FINISHING	WATT	LUMEN	WATT LIGHT SOURCE	LUMEN LIGHT SOURCE	BEAM	KELVIN	KG	PRICE
41705	Nero/Black	12W	890	12W	1680	55°	3000K	0,66	89,84
41706	Bianco/White	12W	890	12W	1680	55°	3000K	0,66	89,84

INSTALLAZIONE APPLICATION



Soffitto/Ceiling

DISEGNI TECNICI TECHNICAL DRAWINGS





ALTAIR 9.8W

LED
CRI
PF

EPISTAR
>90
0.9

CODE	FINISHING	WATT	LUMEN	WATT LIGHT SOURCE	LUMEN LIGHT SOURCE	BEAM	KELVIN	KG	PRICE
42735	Bianco/White	9.8W	733	9,8W	940	36°	3000K	0,36	76,68
42736	Nero/Black	9.8W	733	9,8W	840	36°	3000K	0,36	76,68

INSTALLAZIONE APPLICATION



Soffitto/Ceiling

Parete/Wall

DISEGNI TECNICI TECHNICAL DRAWINGS

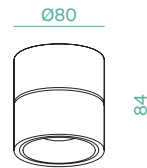

REGOLAZIONI ADJUSTABILITY

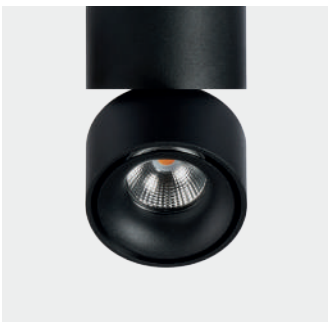

ALTAIR 14W

LED
CRI
PF

EPISTAR
>90
0.9

CODE	FINISHING	WATT	LUMEN	WATT LIGHT SOURCE	LUMEN LIGHT SOURCE	BEAM	KELVIN	KG	PRICE
42751	Bianco/White	14W	1050	14W	1400	36°	3000K	0,67	88,48
42752	Nero/Black	14W	1050	14W	1400	36°	3000K	0,67	88,48

INSTALLAZIONE APPLICATION



Soffitto/Ceiling

Parete/Wall

DISEGNI TECNICI TECHNICAL DRAWINGS

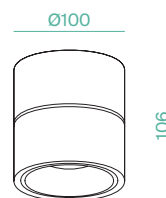

REGOLAZIONI ADJUSTABILITY





BOX DICRO

Lampadina esclusa / Bulb not included

CODE	FINISHING	BASE	KG	PRICE
43166	Nero / Black	GU10 100-240V ~ Max.50W	0,57	69,60
43167	Bianco / White	GU10 100-240V ~ Max.50W	0,57	69,60

INSTALLAZIONE APPLICATION



Soffitto/Ceiling

DISEGNI TECNICI TECHNICAL DRAWINGS

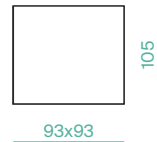

REGOLAZIONI ADJUSTABILITY



BOX 111

Lampadina esclusa / Bulb not included

CODE	FINISHING	BASE	KG	PRICE
43164	Nero / Black	AR111 GU10 100-240V ~ Max.20W	1,10	81,41
43165	Bianco / White	AR111 GU10 100-240V ~ Max.20W	1,10	81,41

INSTALLAZIONE APPLICATION



Soffitto/Ceiling

DISEGNI TECNICI TECHNICAL DRAWINGS



REGOLAZIONI ADJUSTABILITY





CONTAINER

Lampadina esclusa / Bulb not included

CODE	FINISHING	BASE	KG	PRICE
56900/230	Interno nero / Inside black	GU10 230V 50/60Hz~ Max.50W	1,40	123,20
57900/230	Interno bianco / inside white	GU10 230V 50/60Hz~ Max.50W	1,40	123,20

INSTALLAZIONE APPLICATION



Soffitto/Ceiling

DISEGNI TECNICI TECHNICAL DRAWINGS

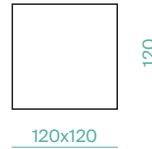

REGOLAZIONI ADJUSTABILITY



CONTAINER

Lampadina esclusa / Bulb not included

CODE	FINISHING	BASE	KG	PRICE
56901/230	Interno nero / Inside black	GU10 230V 50/60Hz~ Max.2x50W	2,20	167,42
57901/230	Interno bianco / Inside white	GU10 230V 50/60Hz~ Max.2x50W	2,20	167,42

INSTALLAZIONE APPLICATION



Soffitto/Ceiling

DISEGNI TECNICI TECHNICAL DRAWINGS



REGOLAZIONI ADJUSTABILITY





CONTAINER

Lampadina esclusa / Bulb not included

CODE	FINISHING	BASE	KG	PRICE
56902/230	Interno nero / Inside black	GU10 230V 50/60Hz~ Max.3x50W	3,60	190,58
57902/230	Interno bianco / inside white	GU10 230V 50/60Hz~ Max.3x50W	3,60	190,58

INSTALLAZIONE APPLICATION



Soffitto/Ceiling

DISEGNI TECNICI TECHNICAL DRAWINGS

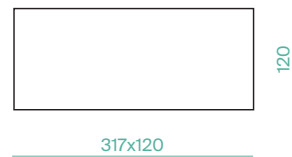

REGOLAZIONI ADJUSTABILITY



CONTAINER 111

Lampadina esclusa / Bulb not included

CODE	FINISHING	BASE	KG	PRICE
53903/230	Interno nero / Inside black	AR111 GU10 230V 50/60Hz~ Max.50W	2,00	148,42
57903/230	Interno bianco / inside white	AR111 GU10 230V 50/60Hz~ Max.50W	2,00	148,42

INSTALLAZIONE APPLICATION



Soffitto/Ceiling

DISEGNI TECNICI TECHNICAL DRAWINGS

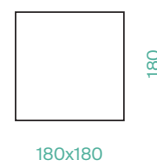

REGOLAZIONI ADJUSTABILITY





CONTAINER 111

Lampadina esclusa / Bulb not included

CODE	FINISHING	BASE	KG	PRICE
56904/230	Interno nero / Inside black	AR111 GU10 230V 50/60Hz~ Max.2x50W	3,20	185,31
57904/230	Interno bianco / inside white	AR111 GU10 230V 50/60Hz~ Max.2x50W	3,20	185,31

INSTALLAZIONE APPLICATION



Soffitto/Ceiling

DISEGNI TECNICI TECHNICAL DRAWINGS

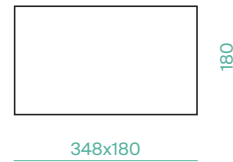

REGOLAZIONI ADJUSTABILITY



CONTAINER 111

Lampadina esclusa / Bulb not included

CODE	FINISHING	BASE	KG	PRICE
56905/230	Interno nero / Inside black	AR111 GU10 230V 50/60Hz~ 3xMax.50W	5,20	236,91
57905/230	Interno bianco / inside white	AR111 GU10 230V 50/60Hz~ 3xMax.50W	5,20	236,91

INSTALLAZIONE APPLICATION



Soffitto/Ceiling

DISEGNI TECNICI TECHNICAL DRAWINGS



REGOLAZIONI ADJUSTABILITY





A+B SOSPENSIONE DALI-PUSH

LED	EPISTAR
CRI	>90
PF	>0.9
SDCM	<6
UGR	<16

CODE	FINISHING	WATT	LUMEN	WATT LIGHT SOURCE	LUMEN LIGHT SOURCE	BEAM	KELVIN	DRIVER	KG	PRICE
41885	Bianco/ White	↓ 26W + ↑ 12W	2412 + 1471	26W+11,6W	3236+1501	90°+ 120°	3000K	38W 30-40V 1050mA	4,0	407,76
41887	Bianco/ White	↓ 26W + ↑ 12W	2629 + 1603	26W+11,6W	3603+1636	90°+ 120°	4000K	38W 30-40V 1050mA	4,0	407,76
41886	Bianco/ White	↓ 38W+ ↑ 20W	3570 + 2317	36W+20W	4109+2685	90°+ 120°	3000K	38W 30-40V 1050mA + 20W 30-40V 500mA	5,2	551,15
41888	Bianco/ White	↓ 38W+ ↑ 20W	3892 + 2525	36W+20W	4782+2926	90°+ 120°	4000K	38W 30-40V 1050mA + 20W 30-40V 500mA	5,2	551,15

INSTALLAZIONE APPLICATION

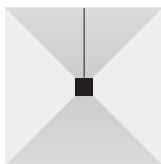

Sospensione/
Suspension

DISEGNI TECNICI TECHNICAL DRAWINGS

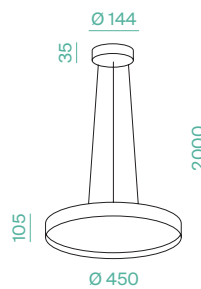

41885
41887

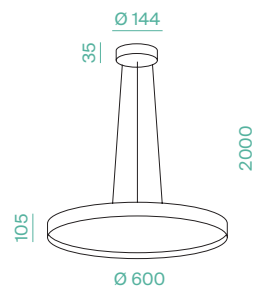

41886
41888



SHANGHAI_30

LED CREE
 CRI 90
 PF 0.5

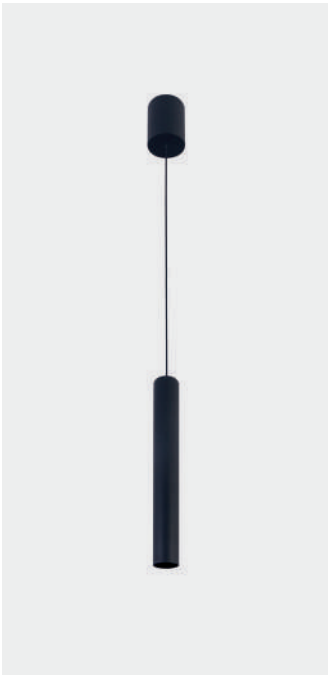

CODE	FINISHING	WATT	LUMEN	WATT LIGHT SOURCE	LUMEN LIGHT SOURCE	BEAM	KELVIN	KG	PRICE
43160	Nero/Black	6W	256	4,8W	450	15°	3000K	0,55	93,20
43161	Bianco/White	6W	256	4,8W	450	15°	3000K	0,55	93,20

INSTALLAZIONE APPLICATION

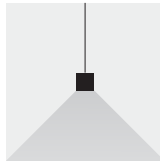

Sospensione/
Suspension

DISEGNI TECNICI TECHNICAL DRAWINGS

Ø60

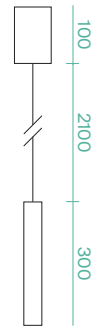

Ø30



SHANGHAI_50

LED CREE
CRI 90
PF 0.5

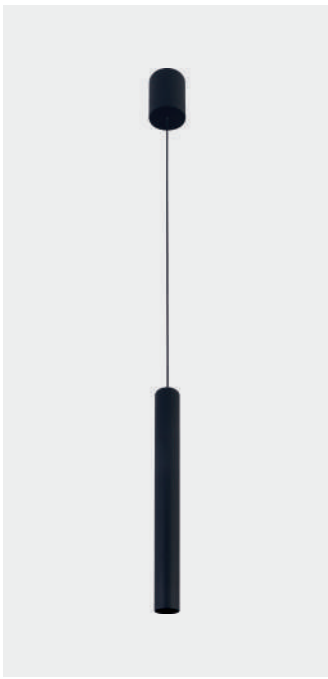

CODE	FINISHING	WATT	LUMEN	WATT LIGHT SOURCE	LUMEN LIGHT SOURCE	BEAM	KELVIN	KG	PRICE
43162	Nero/Black	6W	256	4,8W	450	15°	3000K	0,65	105,00
43163	Bianco/White	6W	256	4,8W	450	15°	3000K	0,65	105,00

INSTALLAZIONE APPLICATION

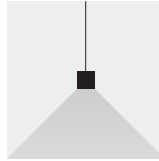

Sospensione/
Suspension

DISEGNI TECNICI TECHNICAL DRAWINGS

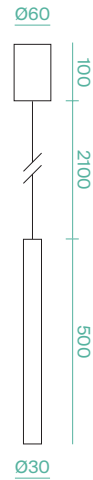



CYL SOSP

LED
CRI
PF

Bridgelux
>90
0.5

CODE	FINISHING	WATT	LUMEN	WATT LIGHT SOURCE	LUMEN LIGHT SOURCE	BEAM	KELVIN	KG	PRICE
41707	Nero/Black	12W	890	12W	1680	55°	3000K	0,86	110,19
41708	Bianco/White	12W	890	12W	1680	55°	3000K	0,86	110,19

INSTALLAZIONE APPLICATION

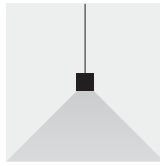

Sospensione/
Suspension

DISEGNI TECNICI TECHNICAL DRAWINGS

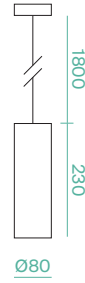



MINIMA

LED	Seoul SC
CRI	90
PF	0.9
SDCM	3

CODE	FINISHING	WATT	LUMEN	WATT LIGHT SOURCE	LUMEN LIGHT SOURCE	BEAM	KELVIN	MODE	KG	PRICE
42706	Bianco/White	18W	1980	18W	2070	120°	3000K	Dimm. taglio di fase/ Phase cut dimming	0,85	245,70
42707	Nero/Black	18W	1980	18W	2070	120°	3000K	Dimm. taglio di fase/ Phase cut dimming	0,85	245,70

INSTALLAZIONE APPLICATION



Parete/Wall

DISEGNI TECNICI TECHNICAL DRAWINGS

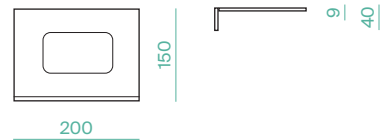

MINIMA L

LED	Seoul SC
CRI	90
PF	0.9
SDCM	3

CODE	FINISHING	WATT	LUMEN	WATT LIGHT SOURCE	LUMEN LIGHT SOURCE	BEAM	KELVIN	MODE	KG	PRICE
42708	Bianco/White	24W	2600	24W	2750	120°	3000K	Dimm. taglio di fase/ Phase cut dimming	1,20	271,95
42709	Nero/Black	24W	2600	24W	2750	120°	3000K	Dimm. taglio di fase/ Phase cut dimming	1,20	271,95

INSTALLAZIONE APPLICATION



Parete/Wall

DISEGNI TECNICI TECHNICAL DRAWINGS

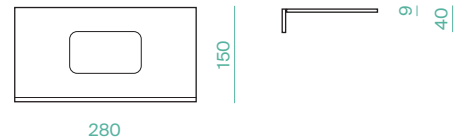



DUMBO FLEX

LED Seoul
CRI >80
PF >0.5

CODE	FINISHING	WATT	LUMEN	WATT LIGHT SOURCE	LUMEN LIGHT SOURCE	KELVIN	DRIVER	KG	PRICE
42619	Nero / Black	3W	150	2,76W	154	3000K	700mA 6V	0,30	60,41
42620	Cromo / Chrome	3W	150	2,76W	154	3000K	700mA 6V	0,30	64,18

INSTALLAZIONE APPLICATION



Parete/Wall

DISEGNI TECNICI TECHNICAL DRAWINGS

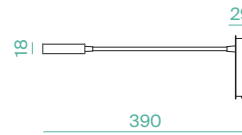

REGOLAZIONI ADJUSTABILITY



DUMBO

LED Seoul
CRI >80
PF >0.5

CODE	FINISHING	WATT	LUMEN	WATT LIGHT SOURCE	LUMEN LIGHT SOURCE	KELVIN	DRIVER	KG	PRICE
42621	Nero / Black	3W	150	2,76W	154	3000K	700mA 6V	0,26	52,86
42622	Cromo / Chrome	3W	150	2,76W	154	3000K	700mA 6V	0,26	56,63

INSTALLAZIONE APPLICATION



Parete/Wall

DISEGNI TECNICI TECHNICAL DRAWINGS

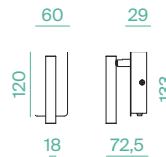

REGOLAZIONI ADJUSTABILITY





BLOC

LED
CRI >80
PF 0.5

CODE	FINISHING	WATT	LUMEN	WATT LIGHT SOURCE	LUMEN LIGHT SOURCE	KELVIN	DRIVER	KG	PRICE
40617	Nero/Black	11W	804	9W	1200	3000K	300mA 22-40V	0,66	74,74
40615	Bianco/White	11W	804	9W	1200	3000K	300mA 22-40V	0,66	74,74

INSTALLAZIONE APPLICATION



Parete/Wall

DISEGNI TECNICI TECHNICAL DRAWINGS

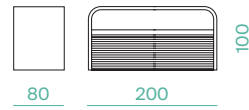



WALL INCASSO

CODE	FINISHING	DESCRIPTION	KG	PRICE
21388	Bianco/White	Profilo 2 mt./Profile 2 mt.	1,65	58,46

INSTALLAZIONE APPLICATION



Incasso/Recessed

DISEGNI TECNICI TECHNICAL DRAWINGS

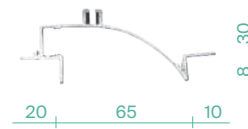

ACCESSORI ACCESSORIES

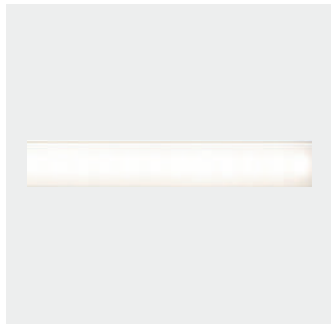

21301

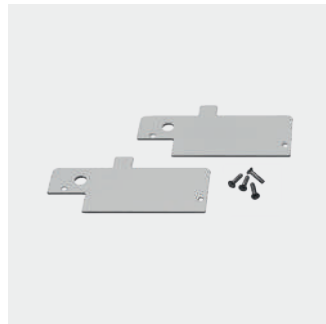

21389

CODE	FINISHING	DESCRIPTION	PRICE
21301	Opale/Opal	Schermo 2 mt./Diffuser 2mt.	5,95
21389	Bianco/White	Kit 4 viti + 2 testate di chiusura/ 4 screws + 2 end caps kit	4,67



ONDA INCASSO

CODE	FINISHING	DESCRIPTION	KG	PRICE
21385	Bianco/White	Profilo 2 mt./Profile 2 mt.	1,80	59,18

INSTALLAZIONE APPLICATION

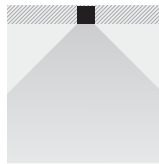

Incasso/Recessed

DISEGNI TECNICI TECHNICAL DRAWINGS



ACCESSORI ACCESSORIES

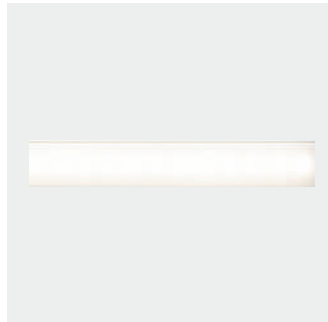

21387

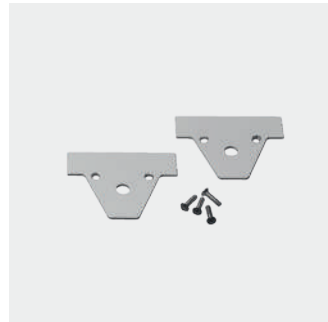

21386

CODE	FINISHING	DESCRIPTION	PRICE
21387	Opale/Opal	Schermo 2 mt./Diffuser 2mt.	5,06
21386	Bianco/White	Kit 4 viti + 2 testate di chiusura/ 4 screws + 2 end caps kit	4,41



LINE_EVO SOFFITTO

CODE	FINISHING	DESCRIPTION	KG	PRICE
11911	Alluminio/Aluminium	Profilo 2 mt/Profile 2 mt	1,20	29,09
11912	Bianco/White	Profilo 2 mt/Profile 2 mt	1,20	29,09
11913	Nero/Black	Profilo 2 mt/Profile 2 mt	1,20	29,09

INSTALLAZIONE APPLICATION



Soffitto/Ceiling

DISEGNI TECNICI TECHNICAL DRAWINGS

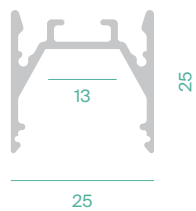

ACCESSORI ACCESSORIES

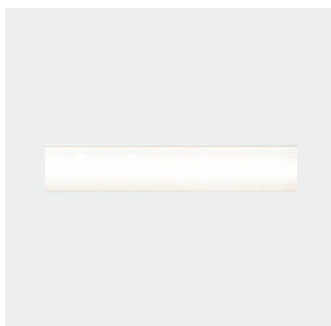

11914



11915

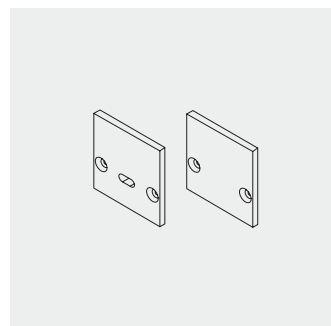

11916, 11917, 11918

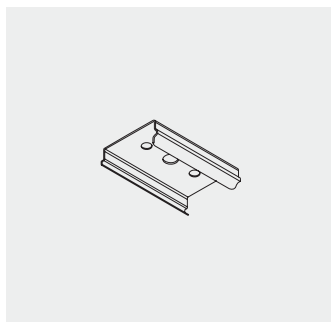

11919

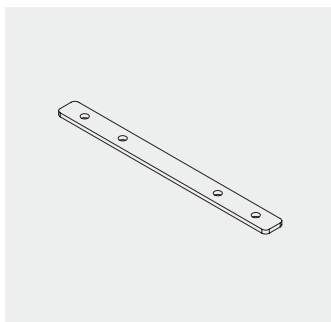

11920

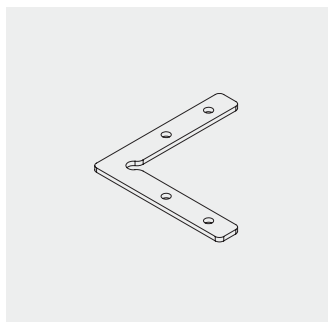

11921

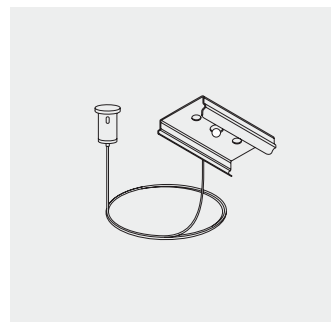

11922

CODE	FINISHING	DESCRIPTION	PRICE
11914	Opale/Opal	Schermo 2 mt/Diffuser 2mt	13,03
11915	Nero/Black	Schermo 2 mt/Diffuser 2mt	13,03
11916	Alluminio/ Aluminium	Kit 4 viti + 2 testate/ 4 screws + 2 end caps kit	8,12
11917	Bianco/White	Kit 4 viti + 2 testate/ 4 screws + 2 end caps kit	8,12
11918	Nero/Black	Kit 4 viti + 2 testate/ 4 screws + 2 end caps kit	8,12
11919	n/a	Kit 2 staffe per soffitto 2 ceiling fixing brackets kit	3,00
11920	n/a	Congiunzione lineare/Linear junction	3,41
11921	n/a	Congiunzione 90°/90° junction	3,41
11922	n/a	Kit 2 sospensioni con cavo 3mt./ 2 suspension kit with 3m steel cable	16,29



LINE DEEP INCASSO

CODE	FINISHING	DESCRIPTION	KG	PRICE
11910	Bianco/White	Profilo 2 mt / Profile 2 mt	1,30	32,09

INSTALLAZIONE APPLICATION



Incasso/Recessed

DISEGNI TECNICI TECHNICAL DRAWINGS

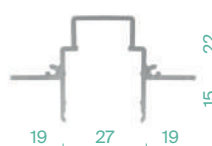

ACCESSORI ACCESSORIES

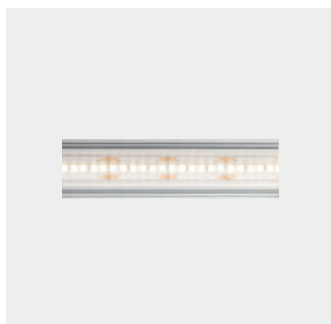

21303

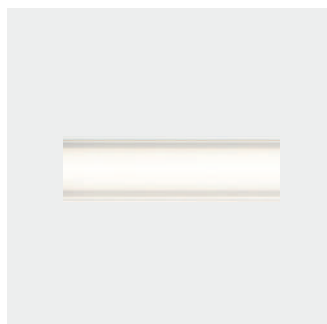

21304

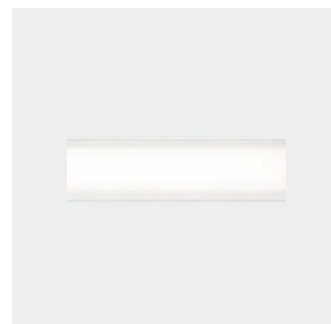

21305

CODE	FINISHING	DESCRIPTION	PRICE
21303	Trasparente/ Transparent	Schermo 2 mt / Diffuser 2mt	6,92
21304	Satinato/Frosted	Schermo 2 mt / Diffuser 2mt	8,97
21305	Opale/Opal	Schermo 2 mt / Diffuser 2mt	6,92



LINE INCASSO

CODE	FINISHING	DESCRIPTION	KG	PRICE
11906	Alluminio/Aluminium	Profilo 2 mt / Profile 2 mt	1,30	32,09

INSTALLAZIONE APPLICATION

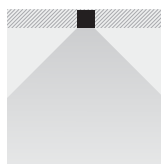

Incasso/Recessed

DISEGNI TECNICI TECHNICAL DRAWINGS

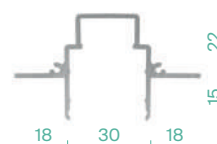

ACCESSORI ACCESSORIES

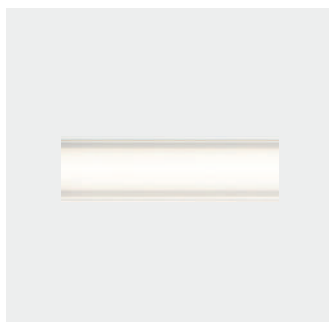

11675

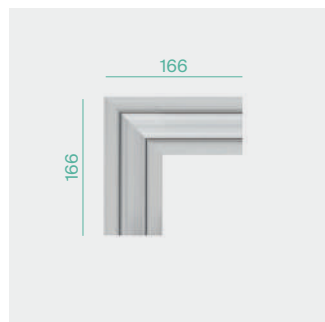

13570

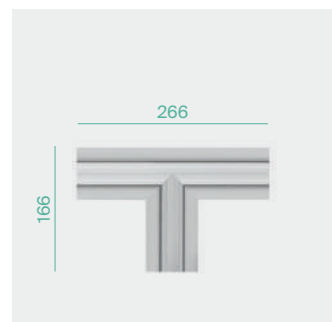

13571

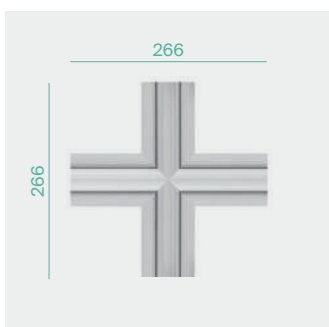

13572

CODE	FINISHING	DESCRIPTION	PRICE
11675	Satinato-opale/Opal-frosted	Schermo PC 2 mt./PC diffuser 2mt.	21,06
13570	Alluminio/Aluminium	Giunto "L"/L-joint	35,70
13571	Alluminio/Aluminium	Giunto "T"/T-joint	44,12
13572	Alluminio/Aluminium	Giunto "X"/X-joint	51,74



DOUBLE SOFFITTO

CODE	FINISHING	DESCRIPTION	KG	PRICE
21472	Alluminio/Aluminium	Profilo 2 mt/Profile 2 mt	0,30	21,48
21473	Bianco/White	Profilo 2 mt/Profile 2 mt	0,30	24,34

INSTALLAZIONE APPLICATION



Soffitto/Ceiling

DISEGNI TECNICI TECHNICAL DRAWINGS

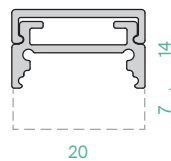

ACCESSORI ACCESSORIES



21476 - 21477

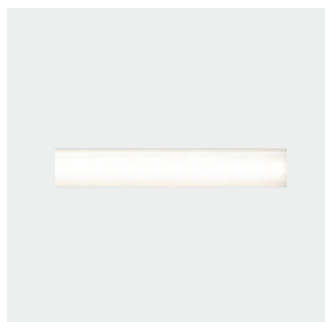

21474

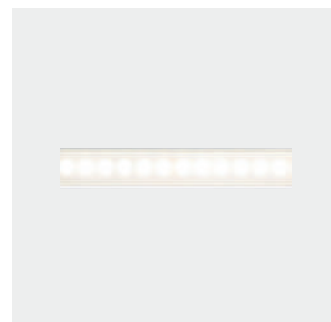

21475

CODE	FINISHING	DESCRIPTION	PRICE
21474	Opale/Opal	Schermo 2 mt./Diffuser 2mt.	6,83
21475	Satinato/Frosted	Schermo 2 mt./Diffuser 2mt.	9,42
21476	Alluminio/Aluminium	Kit 4 viti + 2 testate / 4 screws + 2 end caps kit	0,95
21477	Bianco/White	Kit 4 viti + 2 testate / 4 screws + 2 end caps kit	2,48





PR1 SOFFITTO

CODE	FINISHING	DESCRIPTION	KG	PRICE
21048	Alluminio/Aluminium	Profilo 2 mt/Profile 2 mt	0,20	10,84
21376	Bianco/White	Profilo 2 mt/Profile 2 mt	0,20	13,92

INSTALLAZIONE APPLICATION



Soffitto/Ceiling

DISEGNI TECNICI TECHNICAL DRAWINGS

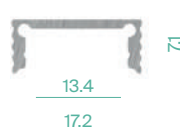

PR1_DEEP SOFFITTO

CODE	FINISHING	DESCRIPTION	KG	PRICE
21494	Alluminio/Aluminium	Profilo 2 mt/Profile 2 mt	0,40	19,49
21495	Bianco/White	Profilo 2 mt/Profile 2 mt	0,40	22,95

INSTALLAZIONE APPLICATION



Soffitto/Ceiling

DISEGNI TECNICI TECHNICAL DRAWINGS

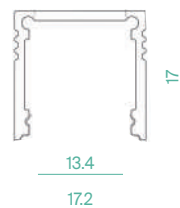

ACCESSORI ACCESSORIES

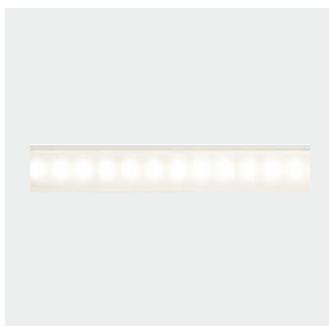

21052

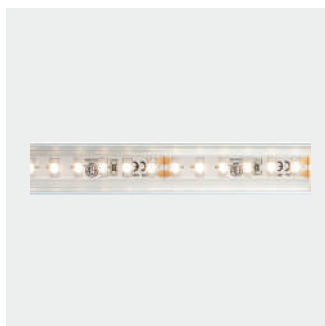

21051



21301



21053 - 21378



21496 - 21497

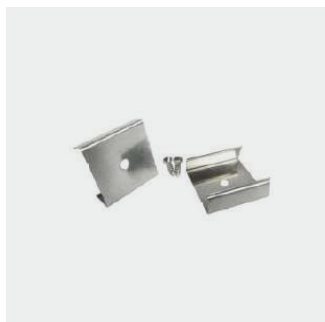

21054 - 21379

CODE	FINISHING	DESCRIPTION	PRICE
21052	Satinato/Frosted	Schermo 2 mt. per PR1, PR1_DEEP/ Diffuser 2mt. for PR1, PR1_DEEP	7,91
21051	Trasparente/ Transparent	Schermo 2 mt. per PR1, PR1_DEEP/ Diffuser 2mt. for PR1, PR1_DEEP	5,95
21301	Opale/Opal	Schermo 2 mt. per PR1, PR1_DEEP/ Diffuser 2mt. for PR1, PR1_DEEP	5,95
21053	Alluminio/ Aluminium	Kit 4 viti + 2 testate per PR1/ 4 screws + 2 end caps kit for PR1	0,84
21378	Bianco/White	Kit 4 viti + 2 testate per PR1/ 4 screws + 2 end caps kit for PR1	2,42
21496	Alluminio/ Aluminium	Kit 4 viti + 2 testate per PR1_DEEP/ 4 screws + 2 end caps kit for PR1_DEEP	2,49
21497	Bianco/White	Kit 4 viti + 2 testate per PR1_DEEP 4 screws + 2 end caps kit for PR1_DEEP	3,39
21054	Alluminio/ Aluminium	Kit 2 staffe fissaggio per PR1, PR1_DEEP/ 2 fixing brackets kit for PR1, PR1_DEEP	0,57
21379	Bianco/White	Kit 2 staffe fissaggio per PR1, PR1_DEEP/ 2 fixing brackets kit for PR1, PR1_DEEP	2,04



PR2 INCASSO

CODE	FINISHING	DESCRIPTION	KG	PRICE
21049	Alluminio/Aluminium	Profilo 2 mt. /Profile 2 mt.	0,22	11,82
21377	Bianco/White	Profilo 2 mt. /Profile 2 mt.	0,22	14,68

INSTALLAZIONE APPLICATION



Incasso/Recessed

DISEGNI TECNICI TECHNICAL DRAWINGS

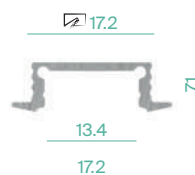

PR2_DEEP INCASSO

CODE	FINISHING	DESCRIPTION	KG	PRICE
21498	Alluminio/Aluminium	Profilo 2 mt/Profile 2 mt	0,44	29,42
21499	Bianco/White	Profilo 2 mt/Profile 2 mt	0,44	33,04

INSTALLAZIONE APPLICATION



Incasso/Recessed

DISEGNI TECNICI TECHNICAL DRAWINGS

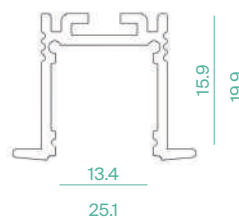

ACCESSORI ACCESSORIES

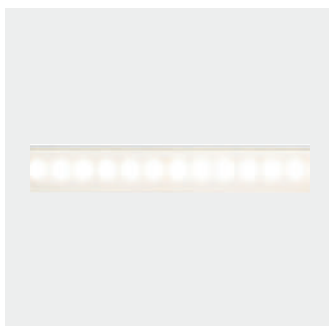

21052

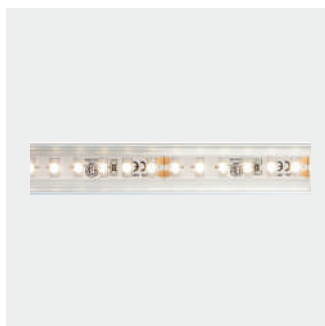

21051

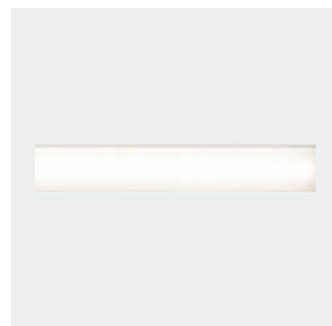

21301



21053 - 21378



21496 - 21497

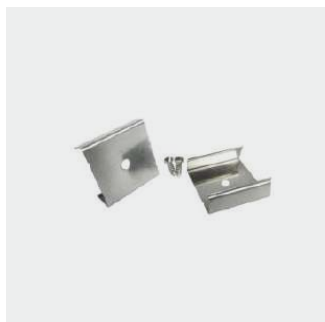

21054 - 21379



21500

CODE	FINISHING	DESCRIPTION	PRICE
21052	Satinato/Frosted	Schermo 2 mt. per PR2, PR2_DEEP/ Diffuser 2mt. for PR2, PR2_DEEP	7,91
21051	Trasparente/ Transparent	Schermo 2 mt. per PR2, PR2_DEEP/ Diffuser 2mt. for PR2, PR2_DEEP	5,95
21301	Opale/Opal	Schermo 2 mt. per PR2, PR2_DEEP/ Diffuser 2mt. for PR2, PR2_DEEP	5,95
21053	Alluminio/ Aluminium	Kit 4 viti + 2 testate per PR2/ 4 screws + 2 end caps kit for PR2	0,84
21378	Bianco/White	Kit 4 viti + 2 testate per PR2/ 4 screws + 2 end caps kit for PR2	2,42
21496	Alluminio/ Aluminium	Kit 4 viti + 2 testate per PR2_DEEP/ 4 screws + 2 end caps kit for PR2_DEEP	2,49
21497	Bianco/White	Kit 4 viti + 2 testate per PR2_DEEP/ 4 screws + 2 end caps kit for PR2_DEEP	3,39
21054	Alluminio/ Aluminium	Kit 2 staffe fissaggio per PR2, PR2_DEEP/ 2 fixing brackets kit for PR2, PR2_DEEP	0,57
21379	Bianco/White	Kit 2 staffe fissaggio per PR2, PR2_DEEP/ 2 fixing brackets kit for PR2, PR2_DEEP	2,04
21500	n/a	Molla per PR2_DEEP 2pz/Spring for PR2_DEEP 2pcs	5,50



PR3_EVO ANGOLO

CODE	FINISHING	DESCRIPTION	KG	PRICE
21440	Alluminio/Aluminium	Profilo 2 mt./Profile 2 mt.	0,30	16,18
21441	Bianco/White	Profilo 2 mt./Profile 2 mt.	0,30	18,22

INSTALLAZIONE APPLICATION



Angolo/Corner

DISEGNI TECNICI TECHNICAL DRAWINGS

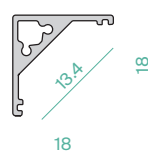

ACCESSORI ACCESSORIES

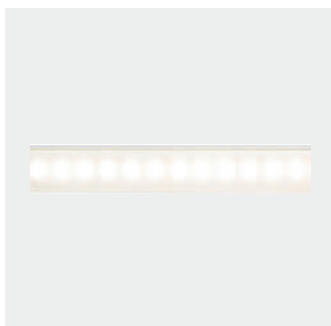

21442

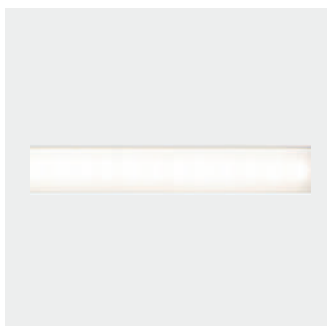

21443



21444 - 21445



21446 - 21447

CODE	FINISHING	DESCRIPTION	PRICE
21442	Satinato/Frosted	Schermo 2 mt. per PR3 EVO/ Diffuser 2mt. for PR3 EVO	8,87
21443	Opale/Opal	Schermo 2 mt. per PR3 EVO/ Diffuser 2mt. for PR3 EVO	6,41
21444	Alluminio/Aluminium	Kit 4 viti + 2 testate per PR3 EVO/ 4 screws + 2 end caps kit for PR3 EVO	0,98
21445	Bianco/White	Kit 4 viti + 2 testate per PR3 EVO/ 4 screws + 2 end caps kit for PR3 EVO	2,79
21446	Alluminio/Aluminium	Kit 2 staffe fissaggio per PR3 EVO/ 2 fixing brackets kit for PR3 EVO	1,06
21447	Bianco/White	Kit 2 staffe fissaggio per PR3 EVO/ 2 fixing brackets kit for PR3 EVO	2,26



TITANO EVO

PARETE

MONO-EMISSIONE

LED
CRI
PF

Edison
>80
0.54 (6W)
0.91 (10W)

CODE	FINISHING	WATT	LUMEN	WATT LIGHT SOURCE	LUMEN LIGHT SOURCE	BEAM	KELVIN	DRIVER	KG	PRICE
43126	Bianco/White	6W	300	4,6W	437	45°	3000K	500mA, 23V	0,85	78,76
43130	Antracite/Anthracite	6W	300	4,6W	437	45°	3000K	500mA, 23V	0,85	78,76
43127	Bianco/White	6W	310	4,7W	448	45°	5000K	500mA, 23V	0,85	78,76
43131	Antracite/Anthracite	6W	310	4,7W	448	45°	5000K	500mA, 23V	0,85	78,76
43128	Bianco/White	10W	700	9W	811	60°	3000K	250mA, 58V	1,40	101,77
43132	Antracite/Anthracite	10W	700	9W	811	60°	3000K	250mA, 58V	1,40	101,77
43129	Bianco/White	10W	720	9,1W	834	60°	5000K	250mA, 58V	1,40	101,77
43133	Antracite Anthracite	10W	720	9,1W	834	60°	5000K	250mA, 58V	1,40	101,77

INSTALLAZIONE APPLICATION



Parete/Wall

DISEGNI TECNICI TECHNICAL DRAWINGS

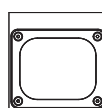

100

100

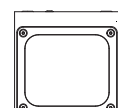

120

120

43126
43127
43130
43131

43128
43129
43132
43133



IP54 IK08





TITANO EVO PARETE BI-EMISSIONE

LED
CRI
PF
Edison
>80
0.57 (2x6W)
0.92 (2x10W)

CODE	FINISHING	WATT	LUMEN	WATT LIGHT SOURCE	LUMEN LIGHT SOURCE	BEAM	KELVIN	DRIVER	KG	PRICE
43134	Bianco / White	6W+6W	300+300	4,6W+ 4,6W	437+437	45°	3000K	500mA, 24V 30V	0,93	89,38
43138	Antracite / Anthracite	6W+6W	300+300	4,6W+ 4,6W	437+437	45°	3000K	500mA, 24V 30V	0,93	89,38
43135	Bianco / White	6W+6W	310+310	4,7W+ 4,7W	448+448	45°	5000K	500mA, 24V 30V	0,93	89,38
43139	Antracite / Anthracite	6W+6W	310+310	4,7W+ 4,7W	448+448	45°	5000K	500mA, 24V 30V	0,93	89,38
43136	Bianco / White	10W+10W	700+700	9W+9W	811+811	60°	3000K	250mA, 98V	1,60	119,46
43140	Antracite / Anthracite	10W+10W	700+700	9W+9W	811+811	60°	3000K	250mA, 98V	1,60	119,46
43137	Bianco / White	10W+10W	720+720	9,1W+9,1W	834+834	60°	5000K	250mA, 98V	1,60	119,46
43143	Antracite / Anthracite	10W+10W	720+720	9,1W+9,1W	834+834	60°	5000K	250mA, 98V	1,60	119,46

INSTALLAZIONE APPLICATION



Parete/Wall

DISEGNI TECNICI TECHNICAL DRAWINGS

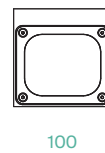

100

43134
43135
43138
43139

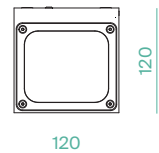

120

43136
43137
43140
43143



IP54 IK08



TITANO EVO PALO

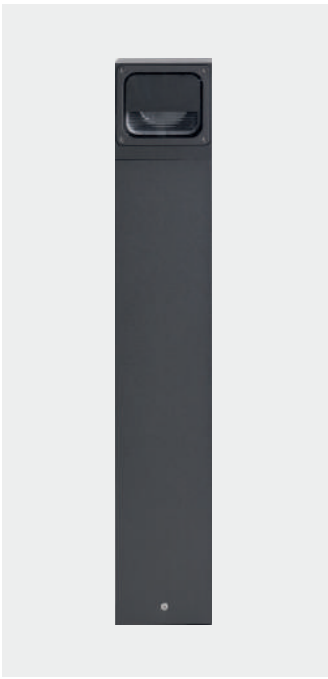

Corpo luminoso non incluso
Lighting source not included

CODE	FINISHING	DESCRIPTION	MEASUREMENTS	KG	PRICE
40580	Antracite/ Anthracite	Accessorio c/griglie antiabbagliamento/ Accessory with anti-glaring grid	120x580	2,20	100,29
40579	Antracite/ Anthracite	Accessorio c/griglie antiabbagliamento/ Accessory with anti-glaring grid	100x500	1,40	76,68

INSTALLAZIONE APPLICATION



Terra/Floor

DISEGNI TECNICI TECHNICAL DRAWINGS

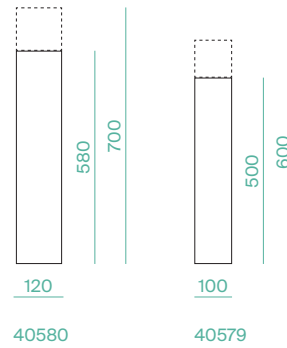



TITANO EVO SOFFITTO

LED
CRI
PF

Edison
>80
0.54 (6W)
0.91 (10W)

CODE	FINISHING	WATT	LUMEN	WATT LIGHT SOURCE	LUMEN LIGHT SOURCE	BEAM	KELVIN	DRIVER	KG	PRICE
43144	Bianco/White	6W	300	4,6W	437	45°	3000K	500mA, 23V	0,85	78,76
43148	Antracite/Anthracite	6W	300	4,6W	437	45°	3000K	500mA, 23V	0,85	78,76
43145	Bianco/White	6W	310	4,7W	448	45°	5000K	500mA, 23V	0,85	78,76
43149	Antracite/Anthracite	6W	310	4,7W	448	45°	5000K	500mA, 23V	0,85	78,76
43146	Bianco/White	10W	700	9W	811	60°	3000K	250mA, 58V	1,40	101,77
43150	Antracite/Anthracite	10W	700	9W	811	60°	3000K	250mA, 58V	1,40	101,77
43147	Bianco/White	10W	720	9,1W	834	60°	5000K	250mA, 58V	1,40	101,77
43151	Antracite/Anthracite	10W	720	9,1W	834	60°	5000K	250mA, 58V	1,40	101,77

INSTALLAZIONE APPLICATION



Soffitto/Ceiling

DISEGNI TECNICI TECHNICAL DRAWINGS

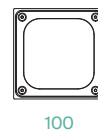

100

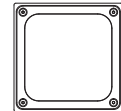

120

43144
43145
43148
43149

43146
43147
43150
43151



LED



IP54 IK08

230V
50/60Hz





MOONLIGHT PALO

LED RF2835
CRI 80
PF 0.9

CODE	FINISHING	WATT	LUMEN	WATT LIGHT SOURCE	LUMEN LIGHT SOURCE	BEAM	KELVIN	DRIVER	KG	PRICE
41167	Antracite/ Anthracite	10W	700	9,5W	1200	90°	3000K	250VDC/ 32mA	1,30	70,79
41168	Antracite/ Anthracite	15W	1050	14,5W	1650	90°	3000K	250VDC/ 48mA	1,60	100,29
41169	Antracite/ Anthracite	20W	1400	19,5W	2120	100°	3000K	250VDC/ 64mA	2,00	163,99

INSTALLAZIONE APPLICATION



Terra/Floor

DISEGNI TECNICI TECHNICAL DRAWINGS

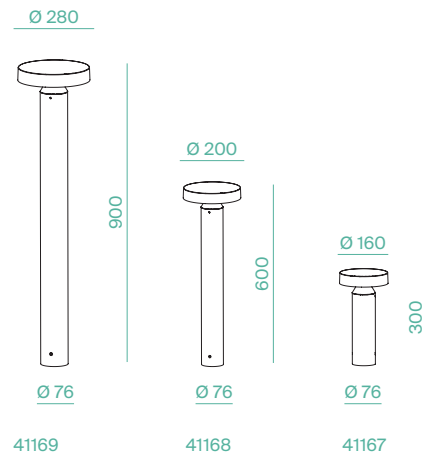

IP65 IK08





MOONLIGHT PARETE

LED RF2835
CRI 80
PF 0.9

CODE	FINISHING	WATT	LUMEN	WATT LIGHT SOURCE	LUMEN LIGHT SOURCE	BEAM	KELVIN	DRIVER	KG	PRICE
41166	Antracite/ Anthracite	15W	1050	14,5W	1650	90°	3000K	250VDC/ 48mA	0,90	73,14

INSTALLAZIONE APPLICATION



Parete/Wall

DISEGNI TECNICI TECHNICAL DRAWINGS

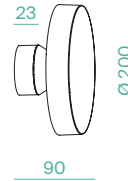

ACCESSORI ACCESSORIES



CODE	DESCRIPTION	PRICE
11554	Distanziale per parete/ Wall mounting spacer	11,33

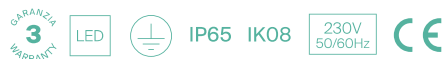



FOS PALO

LED RF2835
CRI 80
PF 0.9

CODE	FINISHING	WATT	LUMEN	WATT LIGHT SOURCE	LUMEN LIGHT SOURCE	BEAM	KELVIN	DRIVER	KG	PRICE
41165	Antracite/ Anthracite	8W	650	6,4W	860	120°	3000K	250VDC/ 48mA	1,70	121,52

INSTALLAZIONE APPLICATION



Terra/Floor

DISEGNI TECNICI TECHNICAL DRAWINGS

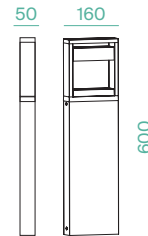

REGOLAZIONI ADJUSTABILITY

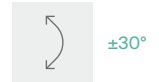

3
GARANZIA
WARRANTY



IP65 IK08

230V
50/60Hz



FOS PARETE

LED RF2835
CRI 80
PF 0.9

CODE	FINISHING	WATT	LUMEN	WATT LIGHT SOURCE	LUMEN LIGHT SOURCE	BEAM	KELVIN	DRIVER	KG	PRICE
41164	Antracite/ Anthracite	8W	650	6,4W	860	120°	3000K	250VDC/ 25mA	1,10	75,51

INSTALLAZIONE APPLICATION



Parete/Wall

DISEGNI TECNICI TECHNICAL DRAWINGS

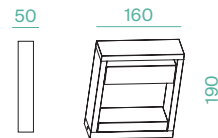

REGOLAZIONI ADJUSTABILITY



3
GARANZIA
WARRANTY



IP65 IK08

230V
50/60Hz





COMBI EVO

LED
CRI >80
PF >0.5

Bridgelux

CODE	FINISHING	WATT	LUMEN	WATT LIGHT SOURCE	LUMEN LIGHT SOURCE	BEAM	KELVIN	DRIVER	KG	PRICE
43168	Bianco/White	5W+5W	445 + 445	4,5W+4,5W	563+563	0-90°	3000K	300mA 100-240V	0,64	84,95
43169	Nero/Black	5W+5W	445 + 445	4,5W+4,5W	563+563	0-90°	3000K	300mA 100-240V	0,64	84,95

INSTALLAZIONE APPLICATION



Parete/Wall

DISEGNI TECNICI TECHNICAL DRAWINGS

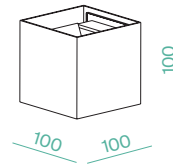

REGOLAZIONI ADJUSTABILITY





DARDO

CODE	FINISHING	WATT	LUMEN	WATT LIGHT SOURCE	LUMEN LIGHT SOURCE	BEAM	KELVIN	KG	PRICE
42790	Antracite/ Anthracite	6W	320	4,2W	397	30°	3000K	1,20	98,28

INSTALLAZIONE APPLICATION



Terra/Floor

Parete/Wall

DISEGNI TECNICI TECHNICAL DRAWINGS

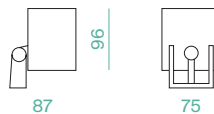

REGOLAZIONI ADJUSTABILITY



ACCESSORI ACCESSORIES

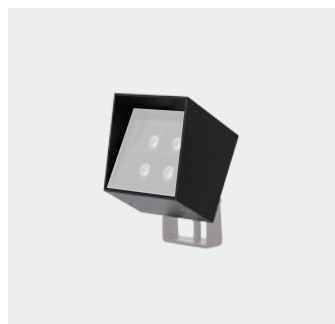

42791



42792

CODE	DESCRIPTION	PRICE
42791	Accessorio anti-glare/Anti-glare accessory	10,62
42792	Accessorio picchetto in plastica/Plastic spike accessory	7,57



IP65 IK08





SKORPIO S

LED
CRI >80
PF 0.5

CODE	FINISHING	WATT	LUMEN	WATT LIGHT SOURCE	LUMEN LIGHT SOURCE	BEAM	KELVIN	KG	PRICE
40248	Inox	4,5W	265	3,2W	332	35°	3000K	0,70	82,45
40249	Inox	4,5W	275	3,1W	359	35°	5000K	0,70	82,45

INSTALLAZIONE APPLICATION



Calpestabile/
Walk-Over

DISEGNI TECNICI TECHNICAL DRAWINGS

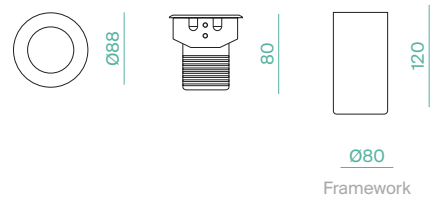

SKORPIO L

LED
CRI >80
PF 0.7

CODE	FINISHING	WATT	LUMEN	WATT LIGHT SOURCE	LUMEN LIGHT SOURCE	BEAM	KELVIN	KG	PRICE
40250	Inox	10W	600	9W	806	35°	3000K	1,42	133,98
40251	Inox	10W	615	9,1W	824	35°	5000K	1,42	133,98

INSTALLAZIONE APPLICATION



Calpestabile/
Walk-Over

DISEGNI TECNICI TECHNICAL DRAWINGS

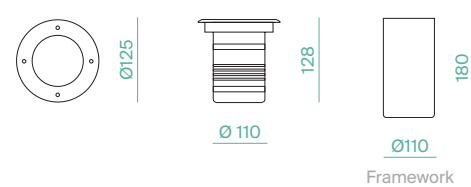

SKORPIO
ACCESSORI
ACCESSORIES



40015



40016

CODE	DESCRIPTION	PRICE
40015	Connettore IP67 1 via / IP67 connector_one exit	8,47
40016	Connettore IP67 2 vie / IP67 connector_two exits	13,87

GRUPPO
EMERGENZA
EMERGENCY
UNIT

CODE	EFFICIENCY	WATT	KG	PRICE
12551	30% - 90 MIN.	MAX 40W	0,10	61,51

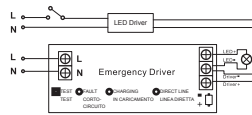
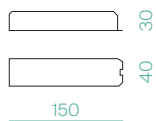

DRIVER

42683 - 42684 - 40314

CODE	VOLTAGE	CURRENT	MODEL	SIZE	MODE	PRICE
42683	220-240 12-42V	650-1100mA	ONE4ALL	125x76x30mm	DALI, PUSH, 1-10V	56,63
42684	220-240 12-42V	250-600mA	ONE4ALL	125x76x30mm	DALI, PUSH, 1-10V	54,27
40314	110-277V 14-42V	400-1100mA	n/a	115x52x30mm	1-10V	49,09



PRICE LIST

Listino IVA esclusa . Eco-fee incluso

CODE	€	PAGE	CODE	€	PAGE	CODE	€	PAGE
11044	213,12	19-29	21303	6,92	100	22034	83,79	19-29
11045	292,62	19-29	21304	8,97	100	40015	8,47	120
11554	11,33	115	21305	6,92	100	40016	13,87	120
11620	20,28	39	21376	13,92	104	40248	82,45	119
11621	20,28	39	21377	14,68	106	40249	82,45	119
11654	153,37	74-80	21378	2,42	105-107	40250	133,98	119
11659	18,88	78-79	21379	2,04	105-107	40251	133,98	119
11660	18,88	78-79	21385	59,18	97	40314	49,09	120
11661	18,88	78-79	21386	4,41	97	40429	21,06	63
11662	18,88	78-79	21387	5,06	97	40430	35,50	63
11663	18,88	78-79	21388	58,46	96	40579	76,68	112
11675	21,06	101	21389	4,67	96	40580	100,29	112
11906	32,09	101	21440	16,18	108	40615	74,74	95
11910	32,09	100	21441	18,22	108	40617	74,74	95
11911	29,09	98	21442	8,87	109	40754	67,13	36
11912	29,09	98	21443	6,41	109	40755	67,13	36
11913	29,09	98	21444	0,98	109	40758	50,14	36
11914	13,03	99	21445	2,79	109	40759	50,14	36
11915	13,03	99	21446	1,06	109	40760	60,17	83
11916	8,12	99	21447	2,26	109	40761	60,17	83
11917	8,12	99	21472	21,48	102	41063	28,14	58
11918	8,12	99	21473	24,34	102	41064	28,14	58
11919	3,00	99	21474	6,83	102	41065	30,26	58
11920	3,41	99	21475	9,42	102	41066	30,26	58
11921	3,41	99	21476	0,95	102	41094	194,66	9
11922	16,29	99	21477	2,48	102	41095	194,66	9
12551	61,51	120	21494	19,49	104	41096	194,66	9
12556	17,58	58-62	21495	22,95	104	41097	194,66	9
12557	11,68	58-62	21496	2,49	105-107	41098	194,66	9
11371	80,00	80	21497	3,39	105-107	41099	194,66	9
13570	35,70	101	21498	29,42	106	41100	194,66	9
13571	44,12	101	21499	33,04	106	41101	194,66	9
13572	51,74	101	21500	5,50	107	41102	194,66	9
21048	10,84	104	22015	34,45	19-29	41103	194,66	9
21049	11,82	106	22016	61,74	19-29	41104	194,66	9
21051	5,95	105-107	22017	132,30	19-29	41105	194,66	9
21052	7,91	105-107	22025	65,05	19-29	41109	105,00	18
21053	0,84	105-107	22031	39,69	19-29	41110	105,00	18
21054	0,57	105-107	22032	50,72	19-29	41111	90,85	10
21301	5,95	96-105-107	22033	65,05	19-29	41112	90,85	10

CODE	€	PAGE	CODE	€	PAGE	CODE	€	PAGE
41113	93,20	14	41193	93,20	14	41680	77,28	32
41114	163,99	14	41194	163,99	14	41681	77,28	32
41115	234,78	14	41195	234,78	14	41682	112,49	54
41116	93,20	14	41196	93,20	14	41683	112,49	54
41117	163,99	14	41197	163,99	14	41684	112,49	54
41118	234,78	14	41198	234,78	14	41685	112,49	54
41119	47,19	12	41199	47,19	12	41686	112,49	54
41120	66,07	12	41200	66,07	12	41687	112,49	54
41121	116,80	12	41201	116,80	12	41688	112,49	54
41122	47,19	12	41202	47,19	12	41689	112,49	54
41123	66,07	12	41203	66,07	12	41690	112,49	54
41124	116,80	12	41204	116,80	12	41691	112,49	54
41125	116,80	13	41205	116,80	13	41692	112,49	54
41126	152,19	13	41206	152,19	13	41693	112,49	54
41127	234,78	13	41207	234,78	13	41694	112,49	54
41128	116,80	13	41208	116,80	13	41695	112,49	54
41129	152,19	13	41209	152,19	13	41696	112,49	54
41130	234,78	13	41210	234,78	13	41697	112,49	54
41131	12,98	19	41211	105,00	15	41705	89,84	83
41132	12,39	19-29	41212	105,00	15	41706	89,84	83
41132/A	12,39	19-29	41213	96,75	10	41707	110,19	92
41133/A	12,39	19-29	41214	96,75	10	41708	110,19	92
41134	4,71	19	41215	128,59	10	41713	85,05	28
41135	4,71	19	41216	128,59	10	41714	85,05	28
41136	51,91	18	41217	149,14	19-29	41715	170,10	28
41137	51,91	18	41218	164,72	19-29	41716	170,10	28
41138	51,91	18	41219	208,13	19-29	41717	46,20	22
41139	51,91	18	41222	8,14	19	41718	46,20	22
41140	51,91	18	41223	8,14	19	41719	80,85	22
41141	51,91	18	41240	19,47	19	41720	80,85	22
41142	8,26	19	41241	19,47	19	41721	142,80	22
41143	8,26	19	41257	57,81	19	41722	142,80	22
41144	210,00	18	41258	57,81	19	41723	65,10	24
41145	210,00	18	41259	57,81	19	41724	65,10	24
41146	6,49	18	41260	57,81	19	41725	114,45	24
41164	75,51	116	41666	77,28	32	41726	114,45	24
41165	121,52	116	41667	77,28	32	41727	166,95	24
41166	73,14	115	41668	77,28	32	41728	166,95	24
41167	70,79	114	41669	77,28	32	41729	109,20	23
41168	100,29	114	41670	77,28	32	41730	109,20	23
41169	163,99	114	41671	77,28	32	41731	166,95	23
41173	105,00	15	41672	77,28	32	41732	166,95	23
41174	105,00	15	41673	77,28	32	41733	81,90	20
41175	96,75	10	41674	77,28	32	41734	81,90	20
41176	96,75	10	41675	77,28	32	41735	85,70	20
41177	128,59	10	41676	77,28	32	41736	85,70	20
41178	128,59	10	41677	77,28	32	41737	99,06	25
41179	90,85	10	41678	77,28	32	41738	99,06	25
41192	90,85	10	41679	77,28	32	41739	96,60	25

CODE	€	PAGE	CODE	€	PAGE	CODE	€	PAGE
41740	96,60	25	41799	64,62	30	41848	136,00	31
41741	90,30	26	41800	64,62	30	41849	136,00	31
41742	90,30	26	41801	95,70	34	41850	136,00	31
41743	87,15	27	41802	95,70	34	41851	151,00	33
41744	87,15	27	41803	95,70	34	41852	151,00	33
41745	86,10	21	41804	64,62	30	41853	151,00	33
41746	86,10	21	41805	64,62	30	41854	151,00	33
41747	48,30	28	41806	64,62	30	41855	174,00	35
41748	48,30	28	41807	64,62	30	41856	174,00	35
41749	48,30	28	41808	95,70	34	41857	174,00	35
41750	48,30	28	41809	95,70	34	41858	136,00	31
41751	48,30	28	41810	95,70	34	41859	136,00	31
41752	48,30	28	41811	64,62	30	41860	136,00	31
41753	53,55	29	41812	64,62	30	41861	136,00	31
41754	53,55	29	41813	64,62	30	41862	151,00	33
41755	53,55	29	41814	64,62	30	41863	151,00	33
41756	53,55	29	41815	95,70	34	41864	151,00	33
41757	4,20	29	41816	95,70	34	41865	151,00	33
41758	4,20	29	41817	95,70	34	41866	174,00	35
41759	7,35	29	41818	64,62	30	41867	174,00	35
41760	7,35	29	41819	64,62	30	41868	174,00	35
41761	7,68	29	41820	64,62	30	41869	64,62	82
41762	7,68	29	41821	64,62	30	41870	64,62	82
41763	12,24	29	41822	95,70	34	41871	64,62	82
41764	6,12	28	41823	95,70	34	41872	64,62	82
41765	18,36	29	41824	95,70	34	41873	64,62	82
41766	18,36	29	41825	136,00	31	41874	64,62	82
41770	96,60	11	41826	136,00	31	41875	64,62	82
41771	96,60	11	41827	136,00	31	41876	64,62	82
41772	135,45	10	41828	136,00	31	41877	64,62	82
41773	135,45	10	41829	151,00	33	41878	64,62	82
41774	90,30	16	41830	151,00	33	41879	64,62	82
41775	90,30	16	41831	151,00	33	41880	64,62	82
41776	87,15	17	41832	151,00	33	41881	64,62	82
41777	87,15	17	41833	174,00	35	41882	64,62	82
41778	86,10	11	41834	174,00	35	41883	64,62	82
41779	86,10	11	41835	174,00	35	41884	64,62	82
41780	25,46	29	41836	136,00	31	41885	407,76	89
41781	25,46	29	41837	136,00	31	41886	551,15	89
41782	25,46	19	41838	136,00	31	41887	407,76	89
41783	25,46	19	41839	136,00	31	41888	551,15	89
41784	161,70	29	41840	151,00	33	41889	364,95	81
41785	216,30	29	41841	151,00	33	41890	514,27	81
41786	266,70	29	41842	151,00	33	41891	364,95	81
41788	161,70	29	41843	151,00	33	41892	514,27	81
41789	216,30	29	41844	174,00	35	42619	60,41	94
41790	266,70	29	41845	174,00	35	42620	64,18	94
41797	64,62	30	41846	174,00	35	42621	52,86	94
41798	64,62	30	41847	136,00	31	42622	56,63	94

CODE	€	PAGE	CODE	€	PAGE	CODE	€	PAGE
42654	233,59	6	42706	245,70	93	42769	160,45	79
42655	233,59	6	42707	245,70	93	42770	160,45	79
42656	233,59	6	42708	271,95	93	42771	160,45	79
42657	233,59	6	42709	271,95	93	42772	160,45	79
42658	322,08	6	42720	116,80	76	42773	160,45	79
42659	322,08	6	42721	116,80	76	42776	283,14	6
42660	322,08	6	42722	116,80	76	42777	283,14	6
42661	322,08	6	42723	116,80	76	42778	283,14	6
42662	378,95	6	42724	127,42	77	42779	283,14	6
42663	378,95	6	42725	127,42	77	42780	424,73	6
42664	378,95	6	42726	127,42	77	42781	424,73	6
42665	378,95	6	42727	127,42	77	42782	424,73	6
42666	473,33	6	42728	5,67	7	42783	424,73	6
42667	473,33	6	42730	46,73	8	42784	175,79	19
42668	473,33	6	42731	46,73	8	42785	192,31	19
42669	473,33	6	42732	25,96	8	42786	234,78	19
42672	7,08	7	42735	76,68	84	42787	175,79	19
42673	12,75	7	42736	76,68	84	42788	192,31	19
42674	12,75	7	42737	18,29	59	42789	234,78	19
42675	17,69	7	42738	18,29	59	42790	98,28	118
42676	17,69	7	42739	18,29	60	42791	10,62	118
42677	15,57	7	42740	18,29	60	42792	7,57	118
42678	15,57	7	42741	18,29	61	42793	114,45	74
42679	5,67	7	42742	18,29	61	42794	114,45	74
42680	5,67	7	42743	10,97	59-60-61	42795	114,45	74
42681	9,67	7	42744	20,64	62	42796	171,15	74
42682	16,75	7	42745	20,64	62	42797	171,15	74
42683	56,63	120	42747	32,91	70	42798	171,15	74
42684	54,27	120	42748	32,91	70	42799	171,15	74
42685	16,75	7	42749	23,48	70	42800	103,95	75
42686	36,88	56	42750	23,48	70	42801	103,95	75
42687	36,88	56	42751	88,48	84	42802	103,95	75
42688	36,88	56	42752	88,48	84	42803	103,95	75
42689	36,88	56	42753	100,29	80	42804	103,95	75
42690	36,88	56	42754	100,29	80	42805	103,95	75
42691	36,88	56	42755	100,29	80	42806	103,95	75
42692	36,88	56	42756	100,29	80	42807	103,95	75
42693	36,88	56	42757	100,29	80	42808	180,60	19
42694	46,48	57	42758	100,29	80	42809	197,40	19
42695	46,48	57	42759	100,29	80	42810	239,40	19
42696	46,48	57	42760	100,29	80	42811	180,60	19
42697	46,48	57	42761	100,29	80	42812	197,40	19
42698	46,48	57	42762	116,80	76	42813	239,40	19
42699	46,48	57	42763	127,42	77	42814	166,95	29
42700	46,48	57	42764	152,19	78	42815	222,60	29
42701	46,48	57	42765	152,19	78	42816	271,95	29
42703	6,96	56	42766	152,19	78	42817	166,95	29
42704	16,39	57	42767	152,19	78	42818	222,60	29
42705	11,33	57	42768	152,19	78	42819	271,95	29

CODE	€	PAGE	CODE	€	PAGE	CODE	€	PAGE
42820	100,29	80	51025	38,81	55	57901/230	167,42	86
43126	78,76	110	51026	42,05	55	57902/230	190,58	87
43127	78,76	110	51027	52,45	55	57903/230	148,42	87
43128	101,77	110	51028	58,12	55	57904/230	185,31	88
43129	101,77	110	52582/B	10,38	39	57905/230	236,91	88
43130	78,76	110	52582/N	10,38	39	60037	34,58	37
43131	78,76	110	53421/GU10	38,19	64	60038	34,58	37
43132	101,77	110	53423/GU10	62,61	64	60040	63,72	37
43133	101,77	110	53425/GU10	87,03	65	60041	63,72	37
43134	89,38	111	53426/GU10	38,19	64	60043	93,05	37
43135	89,38	111	53427/GU10	62,61	64	60044	93,05	37
43136	119,46	111	53428/GU10	87,03	65	60046	23,76	39
43137	119,46	111	53429/GU10	51,48	65	60047	23,76	39
43138	89,38	111	53430/GU10	85,10	66	60049	12,01	39
43139	89,38	111	53431/GU10	121,40	66	60050	12,01	39
43140	119,46	111	53433/GU10	51,48	65	60052	12,01	39
43143	119,46	111	53435/GU10	85,10	66	60053	12,01	39
43144	78,76	113	53437/GU10	121,40	66	60055	1,53	39
43145	78,76	113	53448/GU10	45,28	67	60056	1,53	39
43146	101,77	113	53448B/GU10	45,28	67	60058	6,67	39
43147	101,77	113	53449/GU10	69,12	67	60059	6,67	39
43148	78,76	113	53449B/GU10	69,12	67	60061	21,76	39
43149	78,76	113	53450/GU10	94,25	68	60062	21,76	39
43150	101,77	113	53450B/GU10	94,25	68	60064	21,76	39
43151	101,77	113	53454/GU10	59,40	68	60065	21,76	39
43160	93,20	90	53454B/GU10	59,40	68	60067	30,98	39
43161	93,20	90	53455/GU10	95,04	69	60068	30,98	39
43162	105,00	91	53455B/GU10	95,04	69	60070	30,98	39
43163	105,00	91	53456/GU10	126,37	69	60071	30,98	39
43164	81,41	85	53456B/GU10	126,37	69	60073	30,98	39
43165	81,41	85	53903/230	148,42	87	60074	30,98	39
43166	69,60	85	54511	17,36	71	60076	30,98	39
43167	69,60	85	54519	15,77	72	60077	30,98	39
43168	84,95	117	54523	19,61	73	60079	36,84	39
43169	84,95	117	54527	17,36	71	60080	36,84	39
51011	26,46	55	54531	15,77	72	60084	21,76	39
51012	28,98	55	54539	19,61	73	60085	21,76	39
51013	45,86	55	54541	17,36	71	60086	4,19	39
51014	55,94	55	54542	17,36	71	60087	4,19	39
51015	58,46	55	54543	15,77	72	60088	13,48	39
51016	13,10	55	54544	15,77	72	60089	13,48	39
51017	14,62	55	54545	19,61	73	60091	156,89	41
51018	16,13	55	54546	19,61	73	60092	156,89	41
51019	16,13	55	56900/230	123,20	86	60100	74,96	37
51020	16,13	55	56901/230	167,42	86	60101	74,96	37
51021	20,66	55	56902/230	190,58	87	60102	109,47	37
51022	22,18	55	56904/230	185,31	88	60103	109,47	37
51023	32,26	55	56905/230	236,91	88	60104	2,07	40
51024	32,26	55	57900/230	123,20	86	60105	2,07	40

CODE	€	PAGE	CODE	€	PAGE	CODE	€	PAGE
60106	2,66	40	71622	59,22	52	71726	29,70	50
60107	2,66	40	71623	59,22	52	71727	29,70	50
60108	2,66	40	71624	59,22	52	71728	29,70	50
60109	2,66	40	71625	59,22	52	71729	29,70	46
60110	2,66	40	71626	67,01	52	71730	29,70	46
60111	2,66	40	71627	67,01	52	71731	29,70	46
60112	3,26	40	71628	67,01	52	71732	29,70	46
60113	3,26	40	71629	67,01	52	71733	29,70	46
71575	4,71	30-31-53-82	71645	38,50	44	71734	29,70	46
71582	25,37	42	71646	38,50	44	71735	29,70	46
71583	25,37	42	71647	38,50	44	71736	29,70	46
71584	25,37	42	71648	38,50	44	71737	29,70	46
71585	25,37	42	71649	38,50	44	71738	29,70	46
71586	25,37	42	71650	38,50	44	71739	29,70	46
71587	25,37	42	71651	38,50	44	71740	29,70	46
71588	25,37	42	71652	38,50	44	71741	39,90	47
71589	25,37	42	71653	38,50	44	71742	39,90	47
71590	25,37	42	71654	38,50	44	71743	39,90	47
71591	25,37	42	71655	38,50	44	71744	39,90	47
71592	25,37	42	71656	38,50	44	71745	39,90	47
71593	25,37	42	71657	42,50	45	71746	39,90	47
71594	36,46	43	71658	42,50	45	71747	40,28	52
71595	36,46	43	71659	42,50	45	71748	40,28	52
71596	36,46	43	71660	42,50	45	71749	40,28	52
71597	36,46	43	71661	42,50	45	71750	40,28	52
71598	36,46	43	71662	42,50	45	71751	40,95	52
71599	36,46	43	71663	5,30	32-33-53-54	71752	40,95	52
71600	12,16	51	71664	5,69	34-35	71753	40,95	52
71601	12,16	51	71705	25,37	48	71754	40,95	52
71602	12,16	51	71706	25,37	48	71755	82,13	53
71603	12,16	51	71707	25,37	48	71756	82,13	53
71604	12,16	51	71708	25,37	48	71757	82,13	53
71605	12,16	51	71709	25,37	48	71758	82,13	53
71606	30,21	52	71710	25,37	48	71759	91,35	53
71607	30,21	52	71711	36,46	48	71760	91,35	53
71608	30,21	52	71712	36,46	48	71761	91,35	53
71609	30,21	52	71713	36,46	48	71762	91,35	53
71610	32,57	52	71714	38,50	49	71763	69,98	53
71611	32,57	52	71715	38,50	49	71764	69,98	53
71612	32,57	52	71716	38,50	49	71765	69,98	53
71613	32,57	52	71717	38,50	49	71766	69,98	53
71614	33,75	52	71718	38,50	49	71767	70,20	53
71615	33,75	52	71719	38,50	49	71768	70,20	53
71616	33,75	52	71720	42,50	49	71769	70,20	53
71617	33,75	52	71721	42,50	49	71770	70,20	53
71618	54,03	52	71722	42,50	49	71771	73,80	53
71619	54,03	52	71723	29,70	50	71772	73,80	53
71620	54,03	52	71724	29,70	50	71773	73,80	53
71621	54,03	52	71725	29,70	50	71774	73,80	53

INDICE ANALITICO

- A 81 A+B SOFFITTO
- 84 ALTAIR
- 63 AQUA_COB
- 63 AQUA_SMD

- B 55 BELLATRIX
- 95 BLOC
- 85 BOX 111
- 85 BOX DICRO

- C 117 COMBI EVO
- 86 CONTAINER
- 87 CONTAINER 111
- 83 CYL SOFFITTO
- 92 CYL SOSP

- D 118 DARDO
- 42 DEEP_EVO
- 43 DEEP_EVO LESS
- 44 DEEP_EVO_GU10
- 45 DEEP_EVO LESS_GU10
- 46 DEEP_EVO GRANDE
- 47 DEEP_EVO LESS GRANDE
- 48 DEEP_EVO_Q
- 48 DEEP_EVO_Q LESS
- 49 DEEP_EVO_Q_GU10
- 49 DEEP_EVO LESS_Q_GU10
- 50 DEEP_EVO_Q GRANDE
- 51 DEEP_EVO STD
- 73 DEEP
- 71 DEEP C/VETRO
- 72 DEEP ZERO
- 76 DIOGENE
- 78 DIOGENE HYBRID
- 102 DOUBLE
- 120 DRIVER+EMERGENCY
- 94 DUMBO

- E 41 EMERGENZA TRACK

- F 116 FOS
- 64 FRAME
- 65 FRAME 111
- 67 FRAMELESS
- 68 FRAMELESS 111
- 30 FULGOR TRACK
- 54 FULGOR _IN
- 82 FULGOR SOFFITTO/PARETE

- I 75 IOTA

- K 10 KLIK KLAK
- 20 KLIK KLAK MINI

- L 100 LINE DEEP
- 101 LINE
- 98 LINE_EVO

- M 59 MINI
- 93 MINIMA
- 52 MODULI LED DEEP_EVO
- 114 MOONLIGHT

- O 58 OCCHIO
- 97 ONDA

- P 104 PR1
- 104 PR1_DEEP
- 106 PR2
- 106 PR2_DEEP
- 108 PR3_EVO
- 56 PUNTO
- 57 PUNTO L

- S 119 SKORPIO
- 90 SHANGHAI
- 9 STREAMLIGHT
- 8 STREAMLIGHT INCASSO
- 6 STREAMLIGHT SYSTEM

- T 110 TITANO_EVO
- 37 TRACKS
- 37 TRACKS INCASSO
- 80 TWIGGY_LESS

- U 36 UNICO AR111 TRACK
- 36 UNICO DICRO TRACK
- 83 UNICO DICRO SOFFITTO/PARETE

- W 95 WALL
- 70 WIZARD

- Z 74 ZEN
- 62 ZEUS

LOGICA È UN MARCHIO DI MARINO CRISTAL S.P.A.

Marino Cristal S.p.A.

Via Guardia del Consiglio, 31
47899 Serravalle
Rep. di San Marino

Tel. (+378) 0549 901188
Fax (+378) 0549 900612

www.logicailluminazione.com
info@logicailluminazione.com

Project
Giulia Galassi
Gazmend Zeneli

Print
Pazzini Editore

