



SOLUZIONI VIDEOCITOFONIA



KIT VIDEOCITOFONIA IP FLUSH MOUNTED



**VTK-VTO2000A-S1
(F) VTH1550CH-S1**
€ 830,00



Postazione esterna VTO2000A-S1 (F) Telecamera 1.3Mp CMOS ottica fissa da 2,8mm audio bidirezionale, microfono e altoparlante, 2 entrate di allarme, tamper antisabotaggio*RS485, IP54, IK07* DC 12V *Postazione interna VTH1550CH-S1 Display LCD Touch Screen Capacitivo da 7" *intercomunicante con max 5 postazioni interne, 6 Ingressi Allarme + 1 Uscita * Funzioni Rubrica, registrazione e storico chiamate, pop up su allarme, connessione con porta LAN e connes. LIVE con telecamere IP Dahua. Slot SD Card. Alimentatori inclusi.
***DIMENSIONI:** 200.5mmx136.5mmx22.0mm

FLUSH MOUNTED



Postazione da incasso– MOUNTED (INCLUSA)

Scatola in metallo da incasso VTOB107 125x135x56mm

KIT VIDEOCITOFONIA IP SURFACE MOUNTED



**VTK-VTO2000A-S1
(S) VTH1550CH-S1**
€ 830,00



Postazione esterna VTO2000A-S1 (S) Telecamera 1.3Mp CMOS ottica fissa da 2,8mm audio bidirezionale, microfono e altoparlante, 2 entrate di allarme, tamper antisabotaggio * RS485, IP54, IK07 * DC 12V *Postazione interna VTH1550CH-S1 Display LCD Touch Screen Capacitivo da 7", intercomunicante con max 5 postazioni interne, 6 Ingressi Allarme + 1 Uscita. Funzioni Rubrica, registrazione e storico chiamate, pop up su allarme, connessione con porta LAN e connes. LIVE con telecamere IP Dahua. Slot SD Card. Alimentatori inclusi.
***DIMENSIONI:** 200.5mmx136.5mmx22.0mm

SURFACE MOUNTED



Postazione con Tettuccio – SURFACE (INCLUSA)

Scatola da parete in metallo VTO B108 145X134X88mm

Application

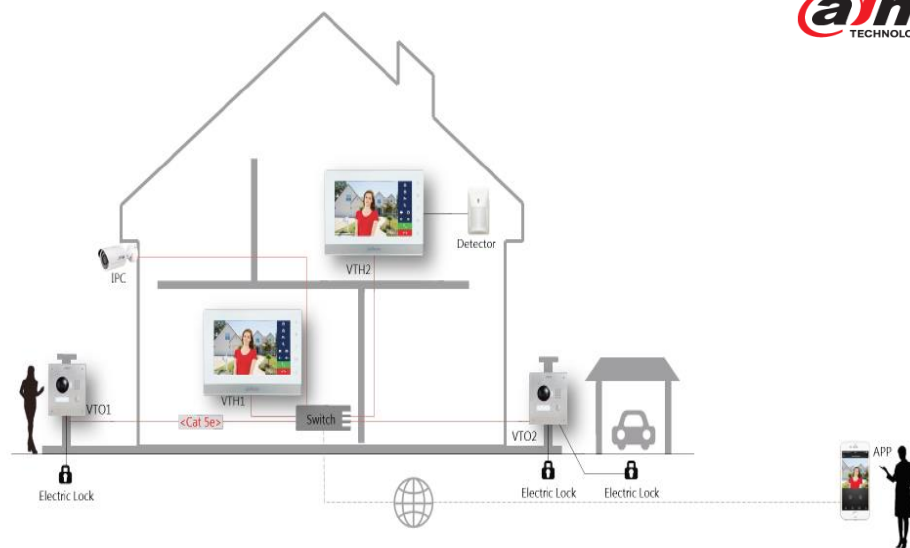

KIT VIDEOCITOFONIA BIFILARE FLUSH MOUNTED



VTK-
VTO2000A-2-S1(F)
VTH1550CHW-2-S1
€ 990,00



Postazione esterna BIFILARE VTO2000A-2-S1, Telec. 1.3Mp CMOS ottica fissa da 2,8mm audio bidirezionale* microfono e altoparlante* 2 entrate di allarme* tamper antisabotaggio * RS485* IP54* IK07* DC 24V*Postazione interna BIFILARE VTH1550CHW-2-S1 Display LCD Touch Screen Capacitivo da 7", intercomunicante con max 5 postazioni interne , 6 Ingres. Allarme + 1 Uscita. Funzioni Rubrica, registraz. e storico chiamate, pop up su allarme, connes. con porta LAN e connes. LIVE con telecamere IP Dahua. Slot SD Card. Aliment. inclusi *DIMENSIONI: 108mmX108mmX64mm



FLUSH MOUNTED

Postazione da incasso esterna –MOUNTED (inclusa)

Scatola in metallo da incasso VTOB107 125x135x56mm

KIT VIDEOCITOFONIA BIFILARE SURFACE MOUNTED



VTK- VTO2000A-2-
S1(S)
VTH1550CHW-2-S1
€ 990,00



Postazione esterna VTO2000A-2-S1 Telecamera 1.3Mp CMOS ottica fissa da 2,8mm audio bidirezionale, microfono e altoparlante, 2 entrate di allarme, tamper antisabotaggio * RS485* IP54* IK07* DC 24V -Postazione interna VTH1550CHW-2-S1 Display LCD Touch Screen Capacitivo da 7" intercomunicante con max 5 postazioni interne , 6 Ingressi Allarme + 1 Uscita.Funzioni Rubrica, registrazione e storico chiamate, pop up su allarme, connes. con porta LAN e connes. LIVE con telecamere IP Dahua. Slot SD Card. Alimentatori inclusi *DIMENSIONI: 108mmX108mmX64mm



SURFACE MOUNTED

Postazione con Tettuccio – SURFACE (inclusa)

Scatola da parete in metallo VTOB108 145x134x88mm

Application

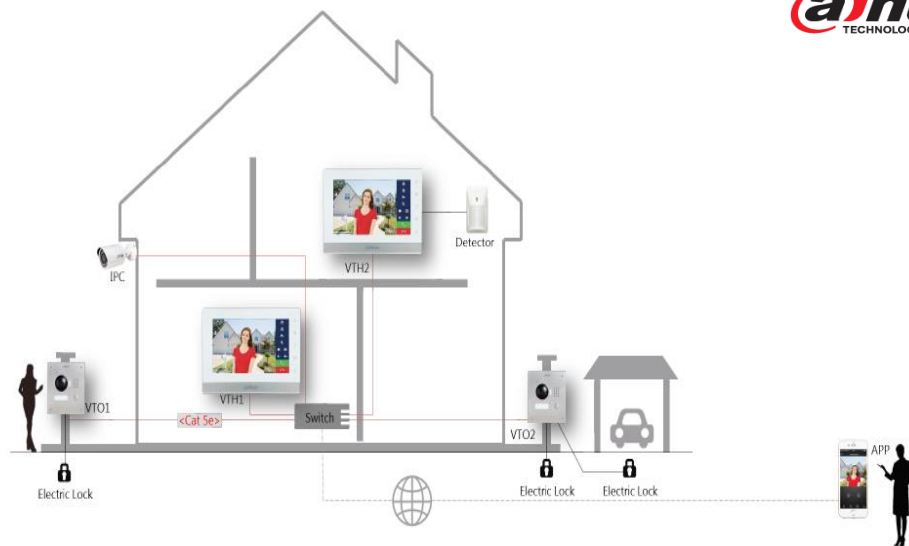



VTO2000A-S1
€ 350,00



Postazione esterna VTO2000A-S1 telecamera 1.3Mp CMOS ottica fissa da 2,8mm audio bidirezionale, microfono e altoparlante, 2 entrate di allarme, tamber antisabotaggio. RS485, IP54, IK07. DC 12V
***DIMENSIONI:** 129.9mm×32.2mm×140mm



VTO2000A-2-S1
€ 410,00



Postazione esterna BIFILARE VTO2000A-2-S1 telecamera 1.3Mp CMOS ottica fissa da 2,8mm audio bidirezionale, microfono e altoparlante, 2 entrate di allarme, tamber antisabotaggio, RS485, IP54, IK07, DC 24V
***DIMENSIONI:** 129.9mm×32.2mm×140mm



VTO2000A-B
€ 80,00

Modulo 3 pulsanti aggiuntivi



VTO2000A-B5
€ 89,00

Modulo 5 pulsanti aggiuntivi



VTOB108
€ 54,00



Scatola da parete in metallo ideale per postazione esterna Dahua VTO2000A. SURFACE - Protezione da pioggia.
***DIMENSIONI:** 145x134x88mm



VTOB107
€ 58,00



Scatola da incasso per postazione esterna Dahua VTO2000A FLUSH
***DIMENSIONI:** 125x135x56mm



VTH1550CH-S2
€ 405,00



Display LCD Touch Screen Capacitivo da 7" , intercomunicante con max 5 postazioni interne, 6 Ingressi Allarme + 1 Uscita. Funzioni Rubrica, registrazione e storico chiamate, pop up su allarme, connessione con porta LAN e connessione LIVE con telecamere IP Dahua. Slot SD Card.

***DIMENSIONI:** 200,45x136,45x22(13)mm



VTH1550CHW-2-S1
€ 460,00



Display LCD Touch Screen Capacitivo da 7" BIFILARE , intercomunicante con max 5 postazioni interne , 6 Ingressi Allarme + 1 Uscita. Funzioni Rubrica, registrazione e storico chiamate, pop up su allarme, connessione con porta LAN e connessione LIVE con telecamere IP Dahua. Slot SD Card.

***DIMENSIONI:** 200,45x136,45x22(13)mm



VTOB111
€ 54,00



Scatola da incasso per installazione a parete della postazione esterna modulare VTO2000A-C e dei relativi moduli VTO2000A-B, VTO2000A-R, VTO2000A-K.

Contiene fino ad un massimo di 2 Moduli.
***DIMENSIONI :** 255.4mm*143.4mm*50.8mm



VTOB112
€ 58,00



Scatola da incasso per installazione a parete della postazione esterna modulare VTO2000A-C e dei relativi moduli VTO2000A-B, VTO2000A-R, VTO2000A-K. Contiene fino ad un massimo di 3 Moduli.

***DIMENSIONI:** 367.4mm*143.4mm*50.8mm



DHI-DEE1010B
€ 80,00



Il modulo DEE1010B consente di espandere le funzionalità del videocitofono con il controllo di un'altra porta o cancello. L'uscita a relè integrata permette di controllare qualsiasi dispositivo NO / NC. L'uscita viene attivata dal videocitofono o telefono cellulare (applicazione DMSS). Alimentazione 12V

***DIMENSIONI:** 58X51X24,5mm



DHI-VTNS1060A
€ 89,00



Switch di alimentazione di rete DHI-VTNS1060A è un dispositivo PoE specializzato che include il protocollo Dahua per collegare e alimentare una combinazione di monitor interni e stazioni esterne (max 6) utilizzando un cavo CAT 5E standard. Questo dispositivo è progettato per essere utilizzato come parte di un sistema di videocitofono I dispositivi collegati direttamente allo switch VTNS1060A sono alimentati con la tensione di 24V DC tramite i cavi di collegamento UTP (cat. 5e).



ADS-65LS1-19-1
€ 58,00

Alimentatore dedicato allo switch VTNS1060A da utilizzare con i sistemi di videocitofonia IP DAHUA. Tensione di alimentazione 100...240v ac Potenza 60 W Tensione di uscita 24 V DC carico massimo dell'alimentatore 2.5A



DHI-VTN3000A
€ 119,00



Modulo di convertitore dei sistemi a 2 fili DAHUA al sistema IP. Consente l'espansione del sistema con le funzioni IP. Il dispositivo è dotato di 4 bus a 2 fili per collegare i monitor e pannelli esterni (alimentazione e trasmissione del segnale) e 1 presa Ethernet per collegare la rete LAN * 24V * VTNC3000A è progettato per lavorare con i videocitofoni e pannelli che operano nello standard DAHUA 2-Wire



DHI-IC-S50 CARD
€ 5,20

Standard: Mifare s50,13,56MHz
Compatibilità: ISO/ICE 14443 A
Range : circa 10cm
***DIMENSIONI:** 86x54x0,80mm *PESO: 0.006kg



DHI-IC-SM
€ 5,20

Portachiavi IC consente il controllo dell'accesso sicuro tramite la tecnologia RFID. E' sintonizzato su 13,56MHz e può essere letto da lettori contact less compatibili da una distanza massima di 3,94

SCHEMA DI COLLEGAMENTO-SOLUZIONE MONOFAMILIARE IP

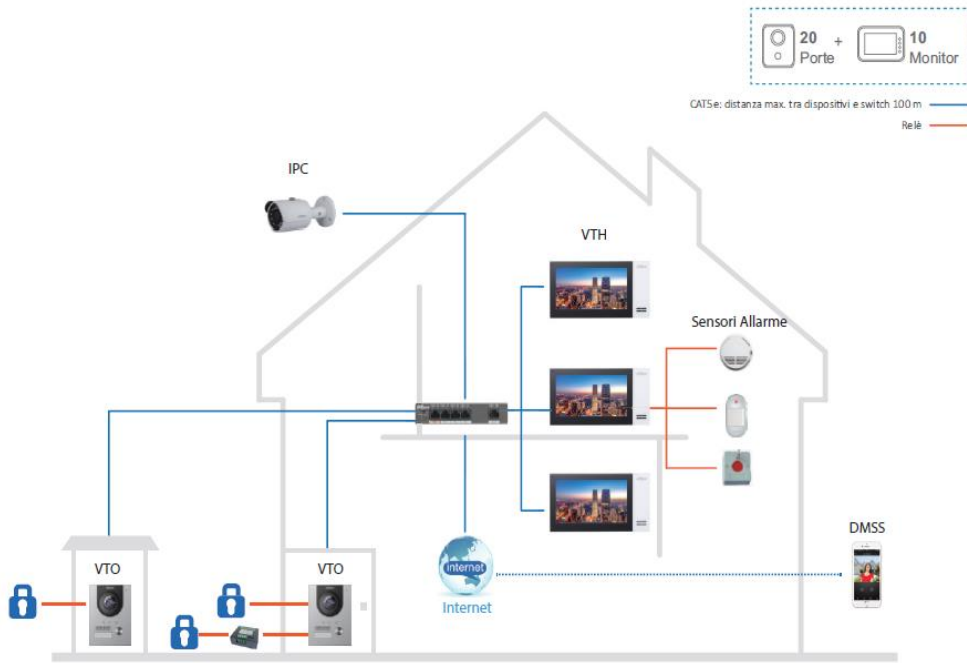

SCHEMA DI COLLEGAMENTO-SOLUZIONE MONOFAMILIARE IP 2 FILI

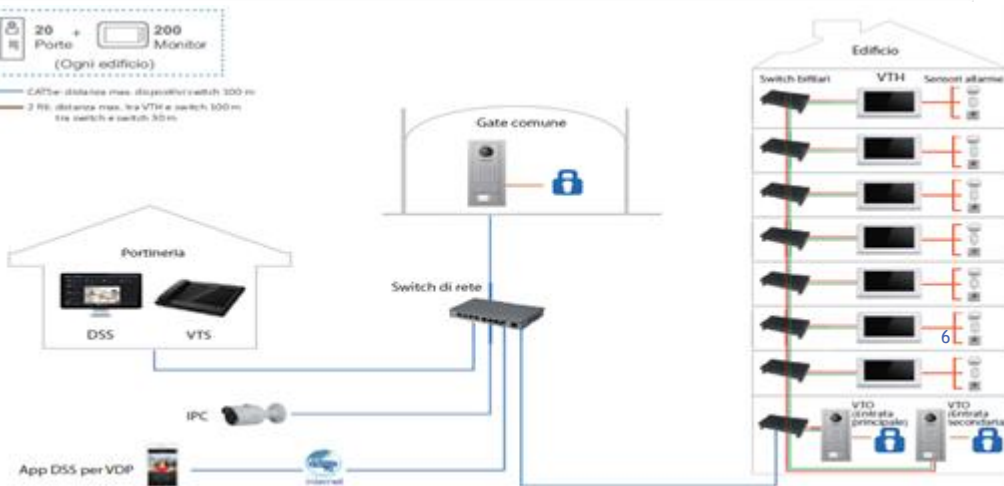
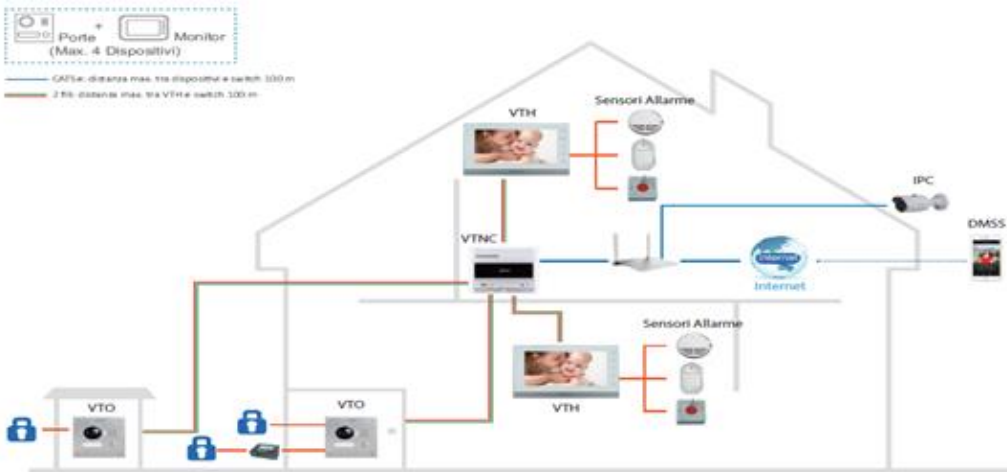



VIDEOCITOFONI SERIE VTO 4202F-X



Esempi di Configurazione



POSTAZIONI ESTERNE MODULARI



DHI -VTO4202F-P
€ 370,00



Modulo pannello frontale in alluminio anodizzato; IK7 -Telecamera postazione esterna- supporta la comunicazione vocale e video - fotocamera di controllo accessi; controlla 2 serrature - fotocamera fisheye da 2MP a 160° - IP65 (Applicare gel di silice negli spazi tra il dispositivo e la parete)

*DIMENSIONI: 100mmX100mm

POSTAZIONI INTERNE MODULARI



DHI-VTH2421 FB
€ 230,00



Postazione Interna IP con display LCD 7" * 1024x600*Compatibilità con sistemi di allarme * Compatibile con sistemi di videosorveglianza IP * Touch screen capacitivo * Supporta slot SD card sino a 8GB * Montaggio a parete o scrivania* Alimentazione 12Vdc o PoE DAHUA (switch VTNS1060A) * Colore Nero

*DIMENSIONI: 119.6 mm x 221.5 mm x 21.5 mm (4.71" x 8.72" x 0.85")



VTH1550CH-S2
€ 405,00



Display LCD Touch Screen Capacitivo da 7", intercomunicante con max 5 postazioni interne, 6 Ingressi Allarme + 1 Uscita. Funzioni Rubrica, registrazione e storico chiamate, pop up su allarme, connessione con porta LAN e connessione LIVE con telecamere IP Dahua. Slot SD Card.

*DIMENSIONI: 200,45x136,45x22(13)mm



DHI-VTH2421FB-P
€ 320,00



Postazione interna IP con display touch screen capacitivo TFT da 7", 1024 x 600 Sorveglianza IPC * Integrazione allarmi * Prestazioni elevate e convenienza * Scheda SD da 8 GB integrata * Supporto PoE standard * Colore: Nero

*DIMENSIONI: 119.6 mm x 221.5 mm x 21.5 mm



DHI-VTH2421FW-P
€ 320,00



Postazione interna IP con display touch screen capacitivo TFT da 7", 1024 x 600 Sorveglianza IPC * Integrazione allarmi * Prestazioni elevate e convenienza * Scheda SD da 8 GB integrata * Supporto PoE standard * Colore: Bianco

*DIMENSIONI: 119.6 mm x 221.5 mm x 21.5 mm

POSTAZIONI ESTERNE MODULARI-PULSANTIERE



DHI -VTO 4202 F B1
€ 65,00



Modulo pulsanti per DHI-VTO4202F-P * Pulsantiera ad 1 bottone per postazione esterna modulare ibrida LAN/bifilare Dahua.

*DIMENSIONI: 100mmX50mm



DHI-VTO 4202 F MB2
€ 78,00



Modulo pulsanti per DHI-VTO4202F-P * Pulsantiera ad 2 bottoni per postazione esterna modulare ibrida LAN/bifilare Dahua

*DIMENSIONI: 100mmX50mm



DHI-VTO 4202 F MB5
€ 92,00



Modulo pulsanti per DHI-VTO4202F-P * Pulsantiera ad 5 bottoni per postazione esterna modulare ibrida LAN/bifilare Dahua

*DIMENSIONI: 100mmX100mm

POSTAZIONI ESTERNE MODULARI



**DHI-
VTO 4202 F MR**
€ 80,00



Modulo per DHI-VTO4202F-P, lettore tessere RFID
***DIMENSIONI:** 100mmx49,90mm



**DHI-
VTO 4202 F MS**
€ 92,00



Modulo per DHI-VTO4202F-P, display STN da 3" * Postazione interna per visualizzare l'utente * Apertura porta * Numero codice dell'utente
***DIMENSIONI:** 100mmx100mm

POSTAZIONI ESTERNE MODULARI ACCESSORI



**DHI-
VTO4202FMF**
€ 240,00

Modulo per DHI-VTO4202F-P in alluminio IP65 antivandalo IK07, lettore impronte digitali
***DIMENSIONI:** 100mmx100mm



DHI-VTO 4202 F MK
€ 180,00

Modulo per DHI-VTO4202F-P, tastiera meccanica
***DIMENSIONI:** 100mmx100mm



DHI-VTO 4202 F ML
€ 70,00

Modulo per DHI-VTO4202F-P in alluminio IP65 antivandalo IK07, led di stato Indicatore parti di campanello, video citofono, parti di controllo di Accesso
***DIMENSIONI:** 100mmx50mm



DHI-VTO 4202 F MN
€ 28,00

Modulo per DHI-VTO4202F-P in alluminio IP65 antivandalo IK07, pannello cieco
***DIMENSIONI:** 100mmx50mm

POSTAZIONI ESTERNE MODULARI



DHI-VTM123
€ 34,00



Supporto da scrivania per postazioni interne di videocitofonia VTH5221E(W)-H e VTH2421FB/W *Materiale: Plastica *Colore : nero
*DIMENSIONI: 190x100x54mm *PESO: 0.23kg



VTM125
€ 118,00



Cornice a 2 unità per moduli di videocitofonia VTO4202F-X * da abbinare a VTM127
Materiale: Alluminio *Colore: Silver
*DIMENSIONI: 140x240,20x7mm



VTM126
€ 138,00



Cornice a 3 unità per moduli di videocitofonia VTO4202F-X da abbinare a VTM128
Materiale: Alluminio *Colore: Silver
*DIMENSIONI: 140x340,40x7mm



VTM127
€ 128,00



Supporto per montaggio su superficie e il montaggio a incasso da abbinare a VTM125
Materiale: Alluminio
Colore: Silver
*DIMENSIONI: 133x233,20x68mm

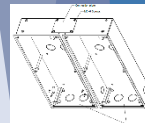

VTM128
€ 138,00



Supporto per montaggio su superficie e il montaggio a incasso da abbinare a VTM126
Materiale: Alluminio
Colore: Silver
*DIMENSIONI: 133x333,40x68mmC

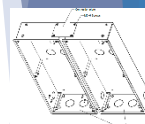

POSTAZIONE ESTERNA VTO 3221 E-P E ACCESSORI



**DHI
VTO3221 E-P**
€ 770,00



Postazione esterna in alluminio con luce bianca * Fotocamera CMOS da 2MP * Pulsante meccanico con Braille * Piastra in lega di alluminio. IK08 * IP65 * Apriporta tramite password e tessera Mifare
*DIMENSIONI: 200x98x32mm * PESO: 1.5 kg



VTM116-01(2)
€ 80,00



Scatola da incasso + scatola con cornice per VTO6221 E-P VTO3221E-P
mensioni (anteriore) 138x240x35mm
*DIMENSIONI: (posteriore) 120,8x222,7x33mm
*DIMENSIONI (apertura muro) 120,8x222,7x33mm

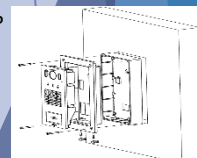

VTM117
€ 40,00



Scatola per montaggio su superficie
Materiale: ADC12
*DIMENSIONI: 97x199x29mm

