

# WIRELESS LIGHT

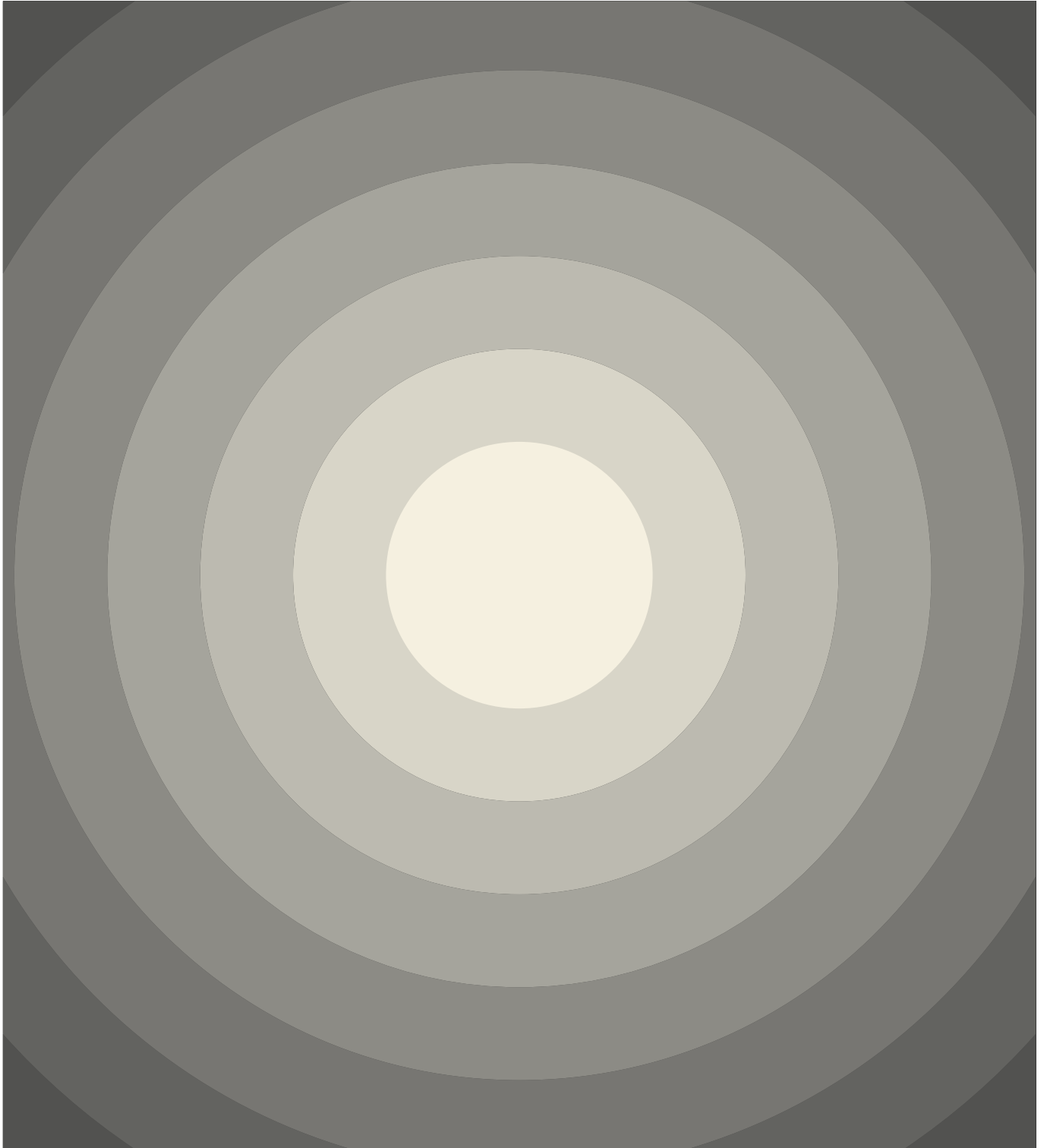

# La luce dove vuoi tu

## *Light where you want it to be*

Porta la luce ovunque con la nostra serie di lampade ricaricabili *Wireless Lights*. Che tu sia in riva al mare, in veranda o in mezzo alla natura, potrai fare affidamento su una serie di prodotti illuminanti indipendenti dalla presa di corrente. La libertà di potersi muovere ti permetterà di allargare l'orizzonte dei tuoi momenti conviviali, dandogli la giusta luce che meritano. La durata della batteria e la resistenza alle intemperie ti garantiranno una corretta illuminazione in qualsiasi situazione per tutto il tempo necessario. Le versioni Hybrid ti consentono inoltre di essere completamente autonomo da fonti elettriche, sfruttando la luce solare tramite un pannello fotovoltaico.

*Carry the light anywhere thanks to our Rechargeable Wireless Lights. No matter where you are, on a beach, on a porch or even surrounded by nature, you can always rely on a series of products which do not need a socket. The freedom to move around will allow you to enlarge the options of your convivial events, providing the requested proper light. The life of the battery and the waterproof protection will ensure the right light in any situation and for the right time. The Hybrid versions will allow you to be completely independent from any power supply taking advantage of the solar light captured through a solar panel mounted on the products.*



Diogene Hybrid bianco



Twiggy\_Less sabbia

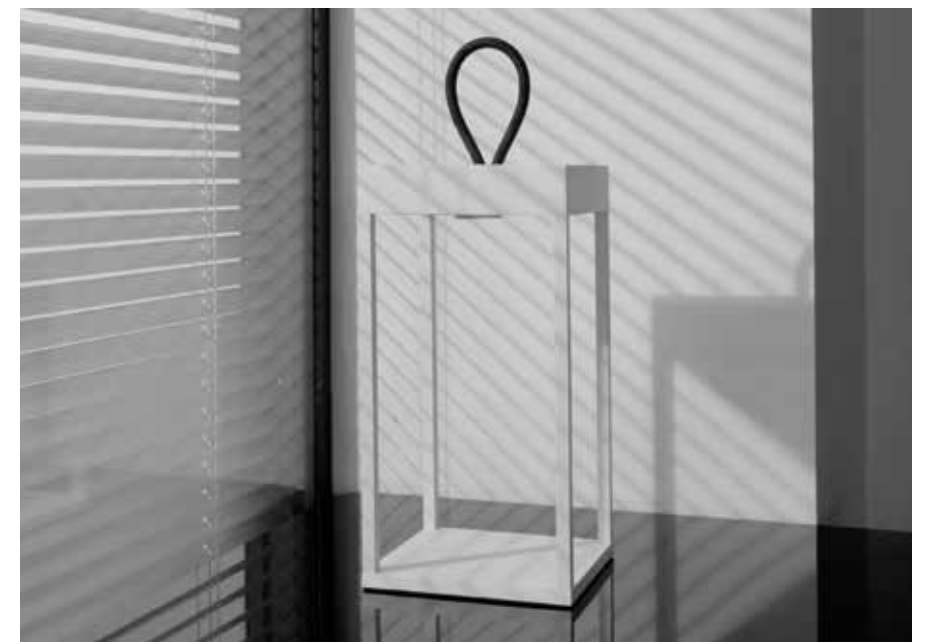

Diogene bianco

# Diogene Hybrid



- Nero  
Black
- Bianco  
White
- Antracite  
Anthracite
- Corten
- Sabbia  
Sand

GARANZIA 5 ANNI
III
IP65 IK06
CE

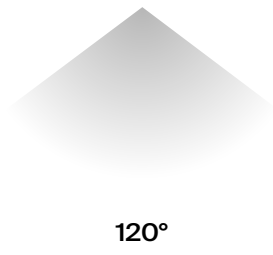
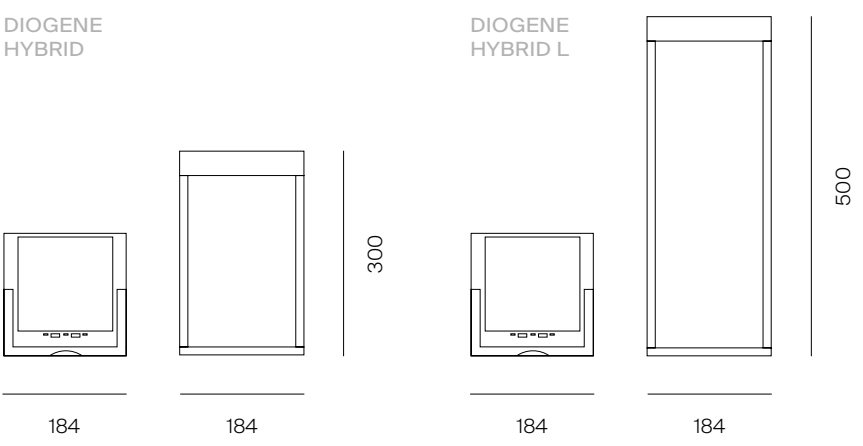

## La nuova arrivata *The newcomer*

Diogene Hybrid fa dell'indipendenza il suo tratto distintivo. Grazie al pannello solare, puoi anche dimenticarti di ricaricarla e farà tutto da sola.

*Diogene Hybrid distinguishes itself for its independence. Thanks to its solar panel, you can even forget to recharge it. Diogene Hybrid will do it on its own.*



## Pannello di controllo Control panel

L'interfaccia permette di scegliere tra l'accensione manuale e quella automatica (Twilight Function), la quale si attiva al crepuscolo grazie ad un sensore che rileva la luce ambientale.

*To turn it on, you can choose between the manual or automatic mode (Twilight Function) which will get into action in the twilight thanks to a sensor which detects the light level in the surrounding area.*

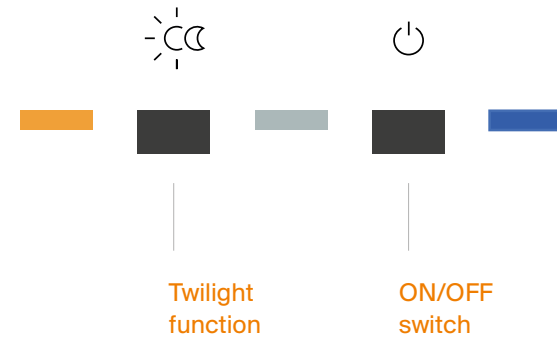

## Ricarica solare Solar recharge

Il pannello solare integrato ricarica Diogene Hybrid in 9 ore.

*The integrated solar panel completely recharges Diogene Hybrid in 9 hours.*

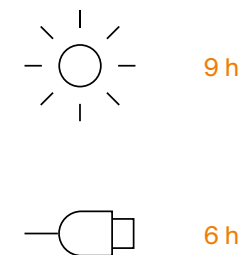



## Regolazione T° colore *Colour temperature setting*

Per una personalizzazione massima, è possibile selezionare la temperatura colore a seconda delle proprie necessità di illuminazione.

*Depending on the lighting effect you want to achieve, colour temperature can be selected.*

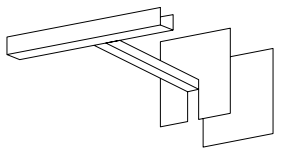
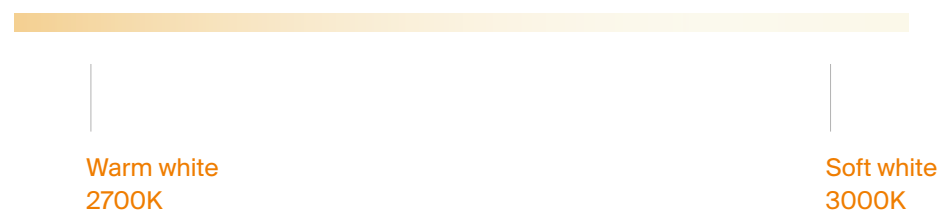

## Accessorio parete *Wall hook*

Un gancio con copertura magnetica permette di appendere discretamente Diogene Hybrid.

*A hook with magnetic cover enables Diogene Hybrid to be discreetly installed as a wall bracket.*

# Diogene



- Nero  
Black
- Bianco  
White
- Antracite  
Anthracite
- Corten
- Sabbia  
Sand

GARANZIA  
5  
ANNI
III
IP65 IK06
CE

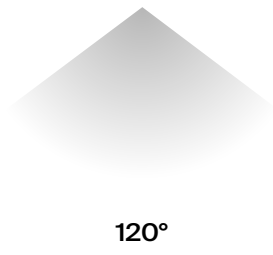
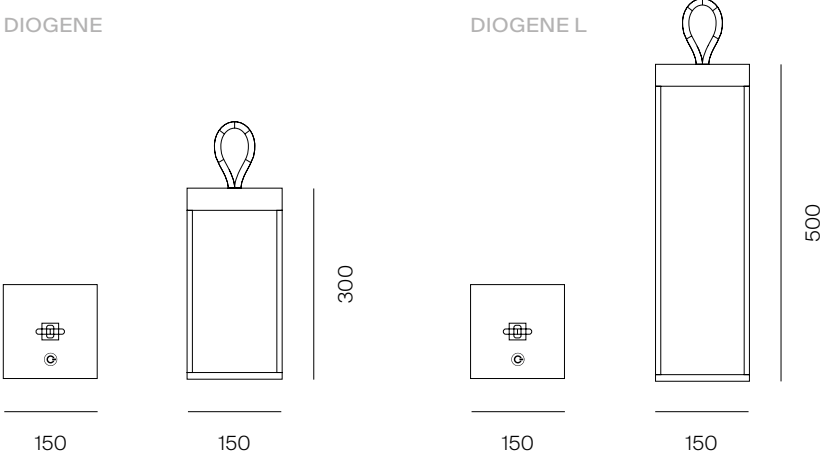

Diogene L bianco

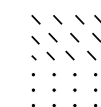

IP65  
Water & dust protection



Stepless dimming









**Diogene si presta ad ogni uso in esterno, grazie all'uso di materiali resistenti alle intemperie con certificazione IP65.**

*Diogene is definitely suitable for outdoor use thanks to the waterproof materials and the relative IP65 certification.*



# Twiggy\_Less



- |   |   |  |  |  |
|---|---|--|--|--|
|  Nero<br>Black    |  Bianco<br>White   |  Antracite<br>Anthracite    |  Corten           |  Sabbia<br>Sand |
|  Giallo<br>Yellow |  Arancio<br>Orange |  Verde Salvia<br>Sage Green |  Blu Avio<br>Blue |  |

 GARANZIA  
5  
ANNI  IP65  IK06 

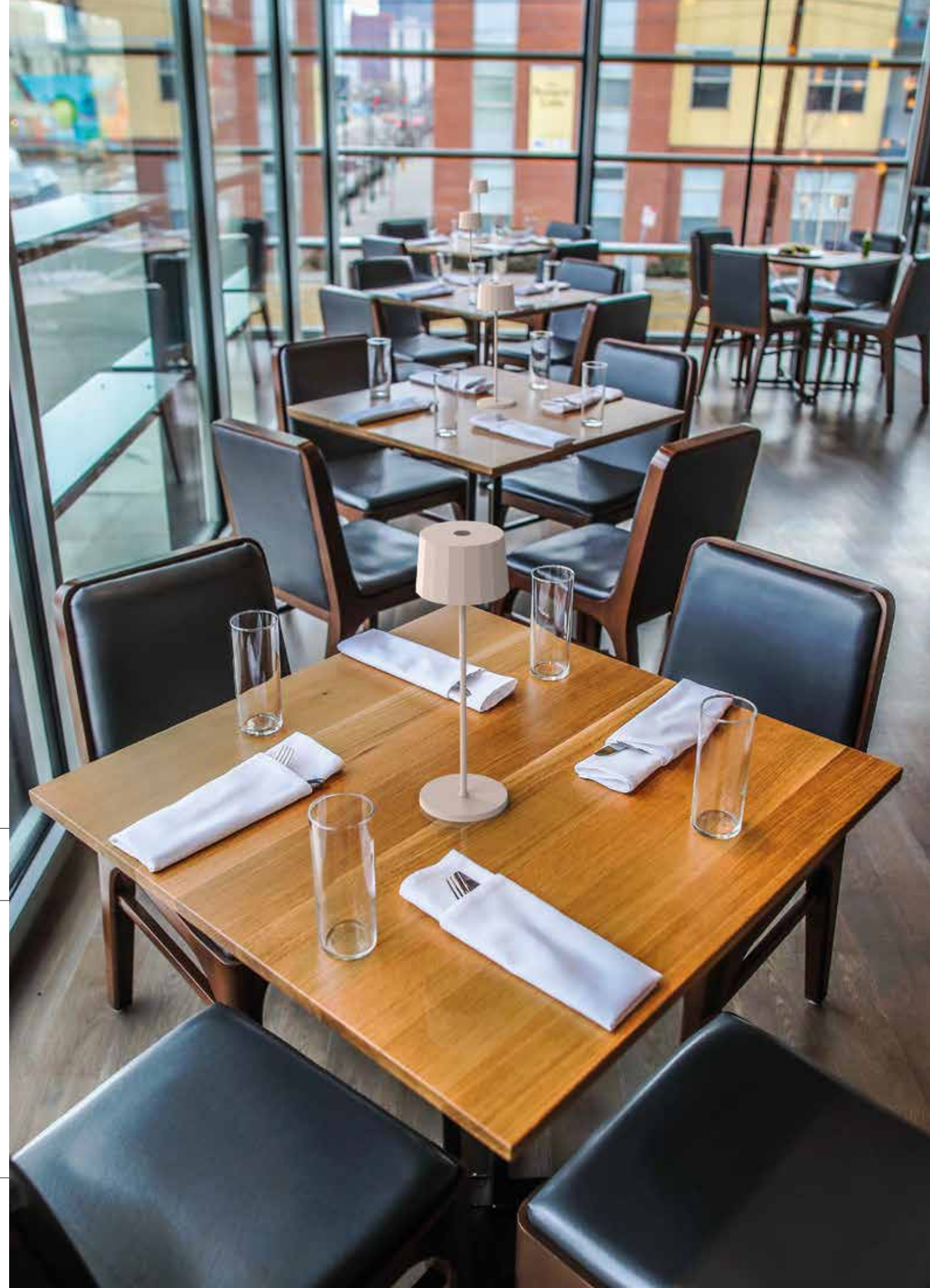
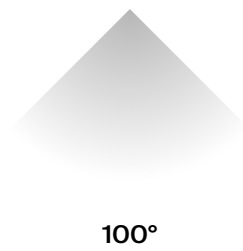
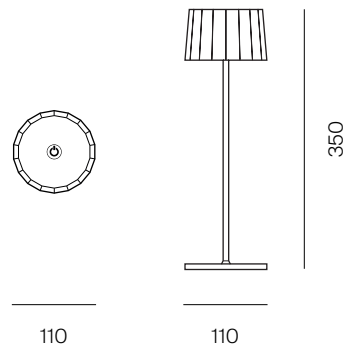

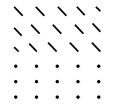

IP65  
Water & dust protection

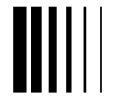

Stepless dimming

**Twiggy si evolve in Twiggy\_Less, con un sistema di ricarica wireless tramite appoggio su base. La dimmerabilità e l'ottica migliorata garantiscono un'illuminazione adeguata senza riflessi.**

*Twiggy develops into Twiggy\_Less with a wireless rechargeable system through a detachable base. The dimmable function and an improved diffuser ensure an excellent anti-glare lighting.*

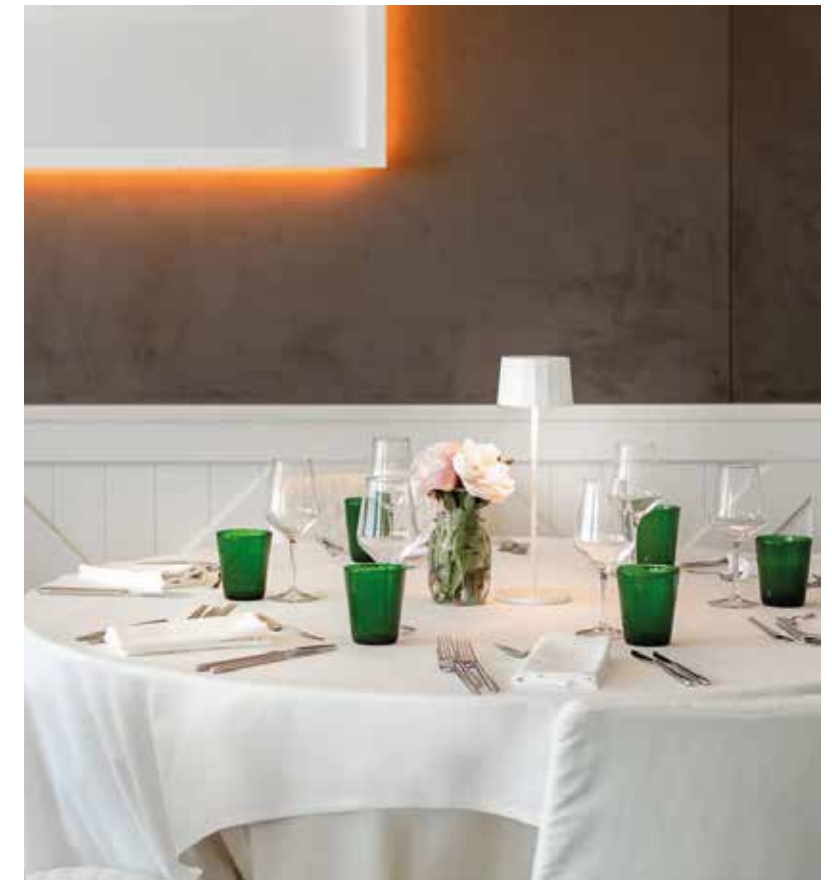

## Regolazione T° colore *Colour temperature setting*

Twiggy\_Less offre la possibilità di selezionare la temperatura colore adeguata alle circostanze.

*Twiggy\_Less allows colour temperature selection depending on the customer's request.*



Warm white  
2700K

Soft white  
3000K



## Base per ricarica multipla *Multiple induction charging base*

Questo sistema permette la ricarica multipla di 6 Twiggy\_Less nello stesso momento. Grazie ai quattro supporti è possibile sovrapporre fino a tre basi per un massimo di 18 Twiggy in carica contemporaneamente.

*This system allows the multiple charging of 6 Twiggy\_Less at the same time. Thanks to the four supports, it's also possible to have up to three shelves being simultaneously recharged so that a total of 18 Twiggy\_Less can be recharged at the same time.*



# Sabbia, il nuovo colore

## *Sand: the new finishing*

Nella gamma cromatica delle *Wireless Lights* si aggiunge Sabbia, delicata sfumatura che sa essere elegante e distinta allo stesso tempo.

Nasce per inserirsi in contesti shabby chic e industriali, ma grazie al suo tono discreto può sposarsi con molteplici situazioni di arredamento.

Disponibile per tutte le serie ricaricabili.

*A new Sand finishing has been added to the Wireless Lights range; it's a delicate nuance, elegant and distinctive at the same time.*

*It is conceived to perfectly blend into a shabby chic or industrial ambience, but also with many other interior design styles. All rechargeable lights are available in Sand finishing.*



## Diogene Hybrid

Code	Finishing	Watt	Volt	Lumen	CRI	Kelvin	LED	Peso / Weight
42764	Antracite/Anthracite	2.2W	DC 3.7V	150	>80	2700/3000K	SMD	1,59kg
42765	Bianco/White	2.2W	DC 3.7V	150	>80	2700/3000K	SMD	1,59kg
42766	Nero/Black	2.2W	DC 3.7V	150	>80	2700/3000K	SMD	1,59kg
42767	Corten	2.2W	DC 3.7V	150	>80	2700/3000K	SMD	1,59kg
42768	Sabbia/Sand	2.2W	DC 3.7V	150	>80	2700/3000K	SMD	1,59kg

Ricarica con pannello solare o cavo USB-C con alimentatore (compreso)/Charging through solar panel or USB-C cable with charger (included)

## Diogene Hybrid L

Code	Finishing	Watt	Volt	Lumen	CRI	Kelvin	LED	Peso / Weight
42769	Antracite/Anthracite	2.2W	DC 3.7V	150	>80	2700/3000K	SMD	1,69kg
42770	Bianco/White	2.2W	DC 3.7V	150	>80	2700/3000K	SMD	1,69kg
42771	Nero/Black	2.2W	DC 3.7V	150	>80	2700/3000K	SMD	1,69kg
42772	Corten	2.2W	DC 3.7V	150	>80	2700/3000K	SMD	1,69kg
42773	Sabbia/Sand	2.2W	DC 3.7V	150	>80	2700/3000K	SMD	1,69kg

Ricarica con pannello solare o cavo USB-C con alimentatore (compreso)/Charging through solar panel or USB-C cable with charger (included)

## Staffa per Diogene Hybrid/Wall mounting bracket

Code	Colore/Color	Descrizione/Description
11659	Antracite/Anthracite	Staffa per montaggio a muro/Wall mounting brackets
11660	Bianco/White	Staffa per montaggio a muro/Wall mounting brackets
11661	Nero/Black	Staffa per montaggio a muro/Wall mounting brackets
11662	Corten	Staffa per montaggio a muro/Wall mounting brackets
11663	Sabbia/Sand	Staffa per montaggio a muro/Wall mounting brackets

## Diogene

Code	Finishing	Watt	Volt	Lumen	CRI	Kelvin	LED	Peso / Weight
42720	Antracite/Anthracite	2.2W	DC 3.7V	200	>80	3000K	SMD	1,6kg
42721	Bianco/White	2.2W	DC 3.7V	200	>80	3000K	SMD	1,6kg
42722	Nero/Black	2.2W	DC 3.7V	200	>80	3000K	SMD	1,6kg
42723	Corten	2.2W	DC 3.7V	200	>80	3000K	SMD	1,6kg
42762	Sabbia/Sand	2.2W	DC 3.7V	200	>80	3000K	SMD	1,6kg

Ricarica con cavo Micro USB con alimentatore (compreso)/Charging through Micro USB cable with charger (included)

## Diogene L

Code	Finishing	Watt	Volt	Lumen	CRI	Kelvin	LED	Peso / Weight
42724	Antracite/Anthracite	2.2W	DC 3.7V	200	>80	3000K	SMD	1,8kg
42725	Bianco/White	2.2W	DC 3.7V	200	>80	3000K	SMD	1,8kg
42726	Nero/Black	2.2W	DC 3.7V	200	>80	3000K	SMD	1,8kg
42727	Corten	2.2W	DC 3.7V	200	>80	3000K	SMD	1,8kg
42763	Sabbia/Sand	2.2W	DC 3.7V	200	>80	3000K	SMD	1,8kg

Ricarica con cavo Micro USB con alimentatore (compreso)/Charging through Micro USB cable with charger (included)

## Twiggy\_Less

Code	Corpo/Body	Watt	Volt	Lumen	CRI	Kelvin	LED	Peso / Weight
42753	Antracite/Anthracite	2.2W	DC 3.7V	150	>80	2700/3000K	SMD	0.85kg
42754	Bianco/White	2.2W	DC 3.7V	150	>80	2700/3000K	SMD	0.85kg
42755	Nero/Black	2.2W	DC 3.7V	150	>80	2700/3000K	SMD	0.85kg
42756	Corten	2.2W	DC 3.7V	150	>80	2700/3000K	SMD	0.85kg
42757	Giallo/Yellow	2.2W	DC 3.7V	150	>80	2700/3000K	SMD	0.85kg
42758	Arancione/Orange	2.2W	DC 3.7V	150	>80	2700/3000K	SMD	0.85kg
42759	Verde Salvia/Sage Green	2.2W	DC 3.7V	150	>80	2700/3000K	SMD	0.85kg
42760	Blu Avio/Blue Avio	2.2W	DC 3.7V	150	>80	2700/3000K	SMD	0.85kg
42761	Sabbia/Sand	2.2W	DC 3.7V	150	>80	2700/3000K	SMD	0.85kg

Ricarica con base di appoggio wireless con alimentatore (compreso)/Charging through wireless base with charger (included)

## Accessorio Twiggy\_Less/Twiggy\_Less accessory

Code	Descrizione/Description	Alimentazione/AC-DC Adaptor
11654	Base ricarica multipla per 6 lampade Multiple charger for 6 lamps	100-240V 50/60Hz 9VDC 5A 45W

# LOGICA

Logica è un marchio  
di Marino Cristal S.p.A.

**Marino Cristal S.p.A.**

Via Guardia del Consiglio 29  
47899 Serravalle  
Rep. di San Marino

Tel. (+378) 0549 901188  
Fax (+378) 0549 900612

[www.logicailuminazione.com](http://www.logicailuminazione.com)  
[info@logicailuminazione.com](mailto:info@logicailuminazione.com)